

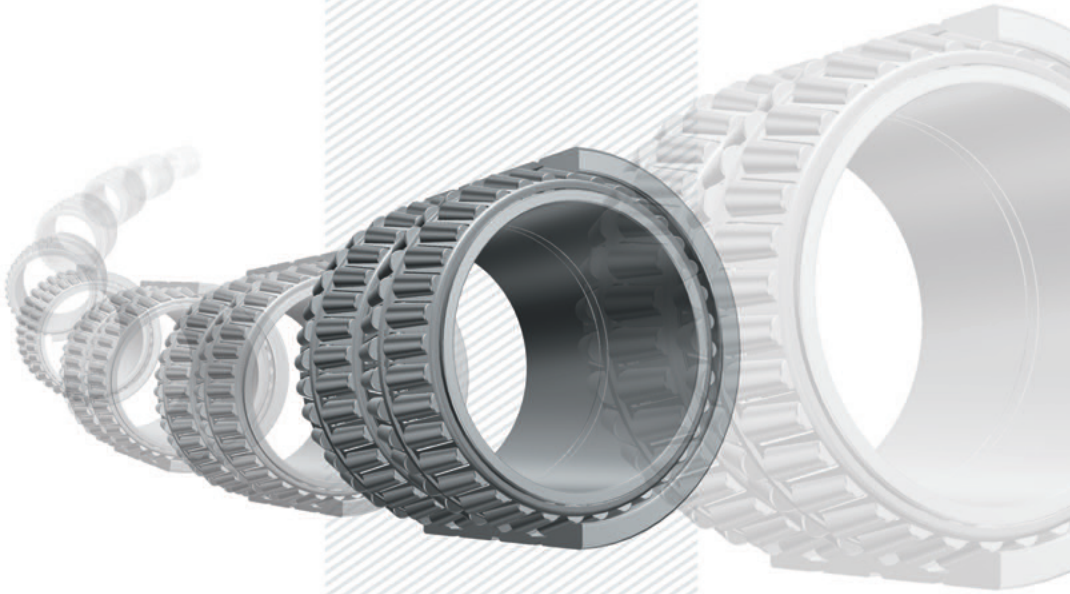

# LARGE SIZE • General Bearings • BALL & ROLLER BEARINGS

---



**JTEKT**

JTEKT CORPORATION

CAT. NO. B2002E

1 Selection of bearing dimensions ... 4	3 Bearing fits ..... 31	5 Lubrication ..... 52	7 Examples of failures .... 66
2 Bearing tolerances ..... 13	4 Internal clearance ..... 43	6 Bearing materials ..... 62	

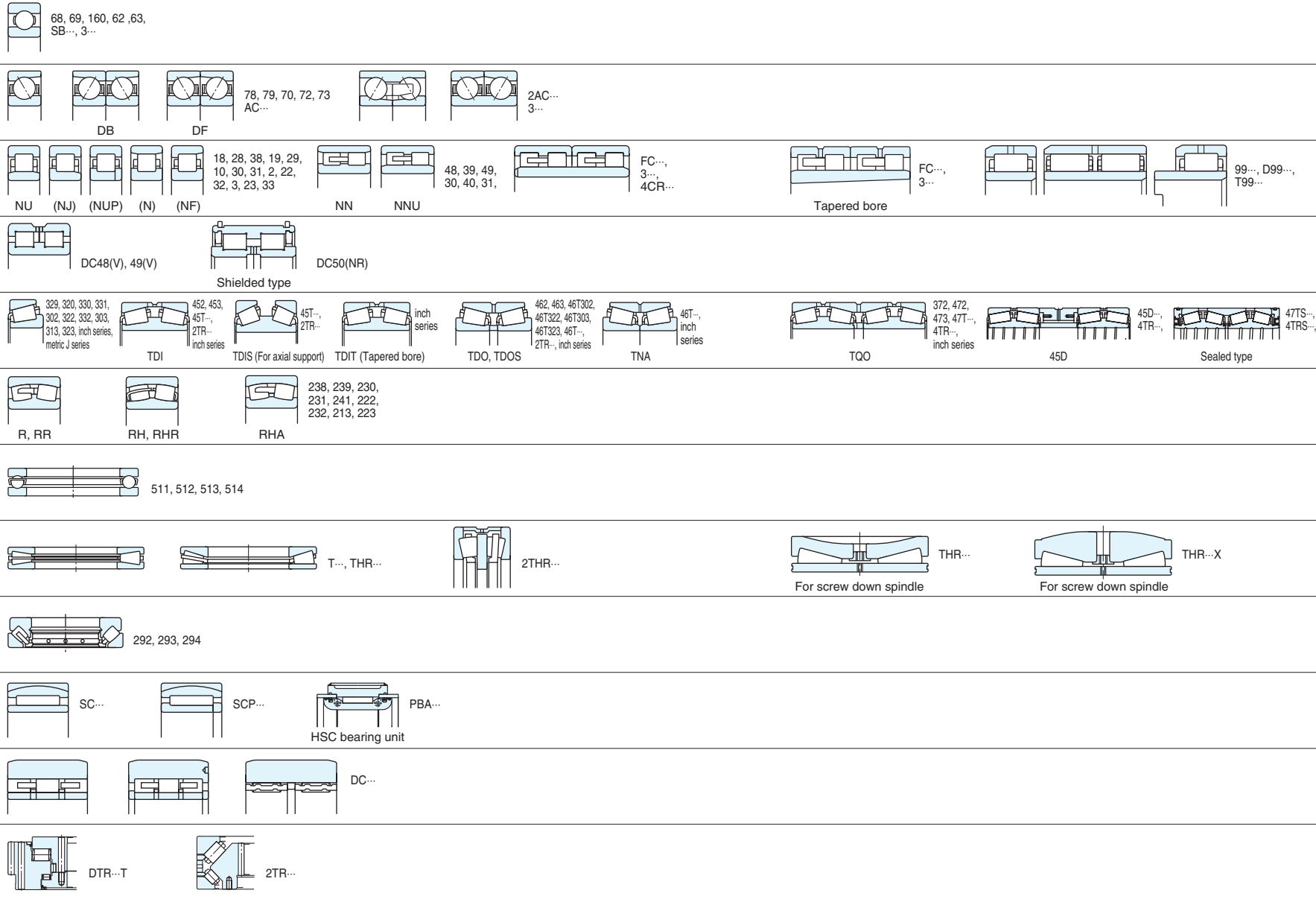

• Other products ..... 460  
 • Supplementary table .... 470

Bearing specification tables	Technical data
	Deep groove ball bearings
	Angular contact ball bearings
	Cylindrical roller bearings
	Full complement cylindrical roller bearings for crane sheaves
	Tapered roller bearings
	Spherical roller bearings
	Thrust ball bearings
	Tapered roller thrust bearings
	Spherical thrust roller bearings
	Bearings for continuous casting machines
	Cylindrical roller bearings for the backing shafts of multi-roll mills
Slewing rim bearings for tunnel-boring machine	
Other products Supplementary table	

**Koyo**<sup>®</sup>

**LARGE SIZE  
BALL & ROLLER  
BEARINGS**

CAT. NO. B2002E

**Value & Technology**

# Publication of LARGE SIZE BALL & ROLLER BEARINGS

We are pleased to offer you this newly issued Koyo large size rolling bearing catalogue.

The conventional large size rolling bearing catalogue has been thoroughly revised. This catalogue includes information such as the latest bearing types, bearing numbers, and technical data.

We are confident that this catalogue will help every people engaged in design and maintenance of machinery.

This catalogue also shows bearings intended for special purposes. If you have any inquiry for selection of bearings, please contact JTEKT. We are grateful for your patronage and look forward to continuing to serve you in the future.

★ The contents of this catalog are subject to change without prior notice. Every possible effort has been made to ensure that the data herein is correct; however, JTEKT cannot assume responsibility for any errors or omissions.

Reproduction of this catalog without written consent is strictly prohibited

This publication was made using recycled paper for the protection of forests.

### Technical data

- 1 Selection of bearing dimensions ..... 4
- 2 Bearing tolerances ..... 13
- 3 Bearing fits ..... 31
- 4 Internal clearance ..... 43

### Bearing specification tables

- **Deep groove ball bearings** ..... 84
  - Single-row ..... 86
- **Angular contact ball bearings** ..... 96
  - Single-row and Matched pair..... 100
  - Double-row..... 112
- **Cylindrical roller bearings** ..... 114
  - Single-row ..... 120
  - Double-row ..... 134
  - Four-row ..... 142
  - Four-row (Tapered bore) ..... 168
- **Wide series cylindrical roller bearings** .. 170
- **Full complement cylindrical roller bearings for crane sheaves** ..... 176
  - Double-row, open type ..... 178
  - Double-row, shielded type..... 182
- **Tapered roller bearings** ..... 186
  - Single-row ..... 192
  - Double-row (Face to face ... TDI type) ..... 230
  - Double-row (Face to face, For axial support ... TDIS type) ..... 250
  - Double-row (Face to face, Tapered bore ... TDIT type) ..... 260
  - Double-row (Back to back ... TDO, TDOS type) .. 264
  - Double-row (Back to back ... TNA type) ..... 310

### Other products

- Spherical roller bearing for wind turbine generator main shaft..... 460
- Back-up roll units for hot leveler..... 461
- Back-up roll units for tension leveler ..... 462
- Ladder bearing for converter..... 464
- Trunnion split bearing for converter ..... 465
- Sealed bearing for sintered equipment ..... 466
- Spherical roller bearings for shaker screens... 467
- Regrinding jigs for bearings for backing shafts ... 468
- Oil / air lubricator for steel making and rolling equipment..... 469

- 5 Lubrication ..... 52
- 6 Bearing materials ..... 62
- 7 Examples of failures ..... 66

- Four-row (TQO type) ..... 314
- Four-row (45D type) ..... 348
- Four-row (Sealed type) ..... 352
- **Spherical roller bearings**..... 366
- **Thrust ball bearings** ..... 394
  - Single-row ..... 396
- **Tapered roller thrust bearings**..... 400
  - Single-row ..... 404
  - Double-row..... 408
  - Single-row (Screw down spindle...THR...type) .... 412
  - Single-row (Screw down spindle...THR...X type) .. 414
- **Spherical thrust roller bearings** ... 418
- **Bearings for continuous casting machines** .. 428
  - SC · SCP bearings ..... 430
  - HSC bearing unit ..... 436
- **Cylindrical roller bearings for the backing shafts of multi-roll mills** .... 442
- **Slewing rim bearings for tunnel-boring machine**.... 448
  - Tripel-row combined roller type (DTR...T type) ..... 450
  - Tripel-row combined roller type (SP/DTR...T type) .. 456
  - Double-row tapered roller type (2TR...type) .... 458

### Supplementary table

- SI units and conversion factors..... 470
- Inch/millimeter conversion ..... 473
- Steel hardness conversion ..... 474
- Viscosity conversion ..... 475
- Shaft tolerances (deviation from nominal dimensions) ..... 476
- Housing bore tolerances (deviation from nominal dimensions) ..... 478

# 1. Selection of bearing dimensions

## 1-1 Bearing service life

When bearings rotate under load, material flakes from the surfaces of inner and outer rings or rolling elements by fatigue arising from repeated contact stress.

This phenomenon is called flaking. The total number of bearing rotations until flaking occurs is regarded as the bearing "(fatigue) service life". "(Fatigue) service life" differs greatly depending upon bearing structures, dimensions, materials, and processing methods.

Since this phenomenon results from fatigue distribution in bearing materials themselves, differences in bearing service life should be statistically considered.

When a group of identical bearings are rotated under the same conditions, the total number of revolutions until 90 % of the bearings are left without flaking (i.e. a service life of 90 % reliability) is defined as the basic rating life. In operation at a constant speed, the basic rating life can be expressed in terms of time.

In actual operation, a bearing fails not only because of fatigue, but other factors as well, such as wear, seizure, creep, fretting, brinelling, cracking etc.

These bearing failures can be minimized by selecting the proper mounting method and lubricant, as well as the bearing most suitable for the application.

## 1-2 Calculation of service life

### 1-2-1 Basic dynamic load rating

The basic dynamic load rating (*C*) is either pure radial (for radial bearings) or central axial load (for thrust bearings) of constant magnitude in a constant direction, under which the basic rating life of 1 million revolutions can be obtained, when the inner ring rotates while the outer ring is stationary, or vice versa. The basic dynamic load rating, which represents the capacity of a bearing under rolling fatigue, is specified as the **basic dynamic radial load rating (*C<sub>r</sub>*) for radial bearings, and basic dynamic axial load rating (*C<sub>a</sub>*) for thrust bearings**. These load ratings are listed in the specification table.

These values are prescribed by ISO 281/1990, and are subject to change by conformance to the latest ISO standards.

### 1-2-2 Basic rating life

The basic rating life in relation to the basic dynamic load rating and dynamic equivalent load can be expressed using equation (1-1).

It is convenient to express the basic rating life in terms of time, using equation (1-2), when a bearing is used for operation at a constant speed.

$$\left( \begin{matrix} \text{Total} \\ \text{revolutions} \end{matrix} \right) L_{10} = \left( \frac{C}{P} \right)^p \dots\dots\dots(1-1)$$

$$\left( \begin{matrix} \text{Time} \end{matrix} \right) L_{10h} = \frac{10^6}{60n} \left( \frac{C}{P} \right)^p \dots\dots\dots(1-2)$$

where :

- L*<sub>10</sub> : basic rating life      10<sup>6</sup> revolutions
- L*<sub>10h</sub> : basic rating life      h
- P* : dynamic equivalent load      N
- .....(refer to page 8)
- C* : basic dynamic load rating      N
- n* : rotational speed      min<sup>-1</sup>
- p* : for ball bearings ..... *p* = 3
- for roller bearings ..... *p* = 10/3

Accordingly, where the dynamic equivalent load is *P*, and rotational speed is *n*, equation (1-3) can be used to calculate the basic dynamic load rating *C*; the bearing size most suitable for a specified purpose can then be selected, referring to the bearing specification table.

$$C = P \left( L_{10h} \times \frac{60n}{10^6} \right)^{1/p} \dots\dots\dots(1-3)$$

[Reference]

The equations using a service life coefficient (*f<sub>h</sub>*) and rotational speed coefficient (*f<sub>n</sub>*) respectively, based on equation (1-2), are as follows :

$$L_{10h} = 500 f_h^p \dots\dots\dots(1-4)$$

Coefficient of service life :

$$f_h = f_n \frac{C}{P} \dots\dots\dots(1-5)$$

Coefficient of rotational speed :

$$f_n = \left( \frac{10^6}{500 \times 60n} \right)^{1/p}$$

$$= (0.03n)^{-1/p} \dots\dots\dots(1-6)$$

For reference, the values of *f<sub>n</sub>*, *f<sub>h</sub>*, and *L*<sub>10h</sub> can be easily obtained by employing the nomograph attached to this catalog, as an abbreviated method.

[Ball bearing]

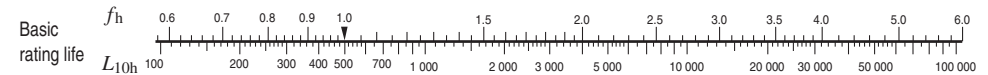
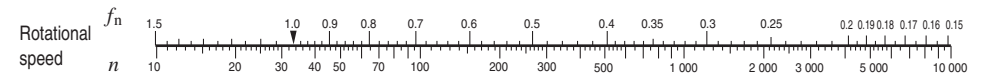

[Roller bearing]

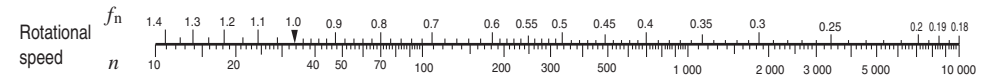

[Reference] Rotational speed (*n*) and its coefficients (*f<sub>n</sub>*), and service life coefficient (*f<sub>h</sub>*) and basic rating life (*L*<sub>10h</sub>)

1. Selection of bearing dimensions

1-2-3 Correction of basic dynamic load rating for high temperature use and dimension stabilizing treatment

In high temperature operation, bearing material hardness deteriorates, as material compositions are altered. As a result, the basic dynamic load rating is diminished. Once altered, material composition is not recovered, even if operating temperatures return to normal.

Therefore, for bearings used in high temperature operation, the basic dynamic load rating should be corrected by multiplying the basic dynamic load rating values specified in the bearing specification table by the temperature coefficient values in Table 1-1.

Table 1-1 Temperature coefficient values

Bearing temperature, °C	125	150	175	200	250
Temperature coefficient	1	1	0.95	0.90	0.75

Since normal heat treatment is not effective in maintaining the original bearing size in extended operation at 120 °C or higher, dimension stabilizing treatment is necessary. Dimension stabilizing treatment codes and their effective temperature ranges are described in Table 1-2.

Since dimension stabilizing treatment diminishes material hardness, the basic dynamic load rating may be reduced for some types of bearings.

Table 1-2 Dimension stabilizing treatment

Dimension stabilizing treatment code	Effective temperature range
S0	Over 100 °C, up to 150 °C
S1	150 °C 200 °C
S2	200 °C 250 °C

1-2-4 Corrected rating life

The basic rating life ( $L_{10}$ ), expressed using equation (1-1), is (fatigue) life, whose estimate of reliability is 90 %. A certain application requires a service life whose reliability is more than 90 %.

Special materials help extend bearing life, and lubrication and other operating conditions may also affect bearing service life.

The corrected rating life can be obtained from the basic rating life using equation (1-7).

$$L_{na} = a_1 a_2 a_3 L_{10} \dots\dots\dots (1-7)$$

where :

$L_{na}$  : corrected rating life 10<sup>6</sup> revolutions  
(estimated reliability (100-n) % : the probability of failure occurrence is expressed by n, taking bearing characteristics and operating conditions into consideration.)

$L_{10}$  : basic rating life 10<sup>6</sup> revolutions  
(estimated reliability 90 %)

$a_1$  : reliability coefficient  
..... refer to section (1)

$a_2$  : bearing characteristic coefficient  
..... refer to section (2)

$a_3$  : operating condition coefficient  
..... refer to section (3)

[Remark]

When bearing dimensions are to be selected given  $L_{na}$  greater than 90 % in reliability, the strength of shaft and housing must be considered.

(1) Reliability coefficient  $a_1$

Table 1-3 describes reliability coefficient,  $a_1$ , which is necessary to obtain the corrected rating life of reliability greater than 90 %.

Table 1-3 Reliability coefficient  $a_1$

Reliability, %	$L_{na}$	$a_1$
90	$L_{10a}$	1
95	$L_{5a}$	0.62
96	$L_{4a}$	0.53
97	$L_{3a}$	0.44
98	$L_{2a}$	0.33
99	$L_{1a}$	0.21

(2) Bearing characteristic coefficient  $a_2$

The bearing characteristic in relation to bearing life may differ according to bearing materials (steel types and their quality), and may be altered by production process, design, etc. In such cases, the bearing life calculation can be corrected using the bearing characteristic coefficient  $a_2$ .

JTEKT has employed vacuum-degassed bearing steel as JTEKT standard bearing material. It has a significant effect on bearing life extension which was verified through studies at JTEKT research & development centers.

The basic dynamic load rating of bearings made of vacuum-degassed bearing steel is specified in the bearing specification table, taking the bearing characteristic coefficient as  $a_2 = 1$ .

For bearings made of special materials to extend fatigue life, the bearing characteristic coefficient is treated as  $a_2 > 1$ .

(3) Operating condition coefficient  $a_3$

When bearings are used under operating conditions which directly affect their service life, including improper lubrication, the service life calculation can be corrected by using  $a_3$ .

Under normal lubrication, the calculation can be performed with  $a_3 = 1$ ; and, under favorable lubrication, with  $a_3 > 1$ .

In the following cases, the operating condition coefficient is treated as  $a_3 < 1$  :

- Operation using lubricant of low kinematic viscosity  
(Ball bearing ..... 13 mm<sup>2</sup>/s or less )  
(Roller bearing ..... 20 mm<sup>2</sup>/s or less )
- Operation at very slow rotational speed  
(Product of rolling element pitch diameter )  
(and rotational speed is 10 000 or less. )
- Contamination of lubricant is expected
- Greater misalignment of inner and outer rings is present

[Note] When bearing hardness is diminished by heat, the basic dynamic load rating calculation must be corrected (ref. Table 1-1).

[Remark]

When  $a_2 > 1$  in employing a special material, if lubrication is not proper,  $a_2 \times a_3$  is not always  $> 1$ . In such cases, if  $a_3 < 1$ , bearing characteristic coefficient is normally treated as  $a_2 \leq 1$ .

As the above explanation shows, since  $a_2$  and  $a_3$  are inter-dependent, some calculations treat them as one coefficient,  $a_{23}$ .

1-3 Calculation of loads

Loads affecting bearings includes force exerted by the weight of the object the bearings support, transmission force of devices such as gears and belts, loads generated in equipment during operation etc.

Seldom can these kinds of load be determined by simple calculation, because the load is not always constant.

In many cases, the load fluctuates, and it is difficult to determine the frequency and magnitude of the fluctuation.

Therefore, loads are normally obtained by multiplying theoretical values with various coefficients obtained empirically.

1-3-1 Load coefficient

Even if radial and axial loads are obtained through general dynamic calculation, the actual load becomes greater than the calculated value due to vibration and impact during operation.

In many cases, the load is obtained by multiplying theoretical values by the load coefficient as shown below.

$$F = f_w \cdot F_c \dots\dots\dots (1-8)$$

where :

$F$  : actual load N  
 $F_c$  : calculated load N  
 $f_w$  : load coefficient (refer to Table 1-4)

Table 1-4 Load coefficient  $f_w$

Operating condition	Application example	$f_w$
Operation with little vibration or impact	Motors Machine tools Measuring instrument	1.0 – 1.2
Normal operation (slight impact)	Railway rolling stock Automobiles Paper manufacturing equipment Air blowers Compressors Agricultural equipment	1.2 – 2.0
Operation with severe vibration or impact	Rolling mills Crushers Construction equipment Shaker screens	2.0 – 3.0

1. Selection of bearing dimensions

1-4 Dynamic equivalent load

Bearings are used under various operating conditions; however, in most cases, bearings receive radial and axial load combined, while the load magnitude fluctuates during operation.

Therefore, it is impossible to directly compare the actual load and basic dynamic load rating.

The two are compared by replacing the loads applied to the shaft center with one of a constant magnitude and in a specific direction, that yields the same bearing service life as under actual load and rotational speed.

This theoretical load is referred to as the dynamic equivalent load ( $P$ ).

1-4-1 Calculation of dynamic equivalent load

Dynamic equivalent loads for radial bearings and thrust bearings ( $\alpha \neq 90^\circ$ ) which receive a combined load of a constant magnitude in a specific direction can be calculated using the following equation.

$$P = XF_r + YF_a \dots\dots\dots (1-9)$$

where :

- $P$  : dynamic equivalent load N
  - $P_r$  : dynamic equivalent radial load (for radial bearings, N)
  - $P_a$  : dynamic equivalent axial load (for thrust bearings, N)
  - $F_r$  : radial load N
  - $F_a$  : axial load N
  - $X$  : radial load factor
  - $Y$  : axial load factor
- (values of  $X$  and  $Y$  are listed in the bearing specification table.)

■ When  $F_a/F_r \leq e$  for single-row radial bearings, it is taken that  $X = 1$ , and  $Y = 0$ . Hence, the dynamic equivalent load rating is  $P_r = F_r$ .

(Values of  $e$ , which designates the limit of  $F_a/F_r$ , are listed in the bearing specification table.)

■ For single-row angular contact ball bearings and tapered roller bearings, axial component forces ( $F_{ac}$ ) are generated as shown in Fig. 1-1, therefore a pair of bearings is arranged face-to-face or back-to-back.

The axial component force can be calculated using the following equation.

$$F_{ac} = \frac{F_r}{2Y} \dots\dots\dots (1-10)$$

Table 1-5 describes the calculation of the dynamic equivalent load when radial loads and external axial loads ( $K_a$ ) are applied to bearings.

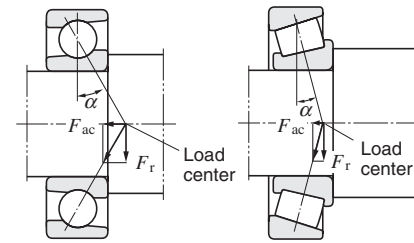

(Load center position is listed in the bearing specification table.)

Fig. 1-1 Axial component force

■ For thrust ball bearings with contact angle  $\alpha = 90^\circ$ , to which an axial load is applied,  $P_a = F_a$ .

■ The dynamic equivalent load of spherical thrust roller bearing can be calculated using the following equation.

$$P_a = F_a + 1.2F_r \dots\dots\dots (1-11)$$

where :  $F_r/F_a \leq 0.55$

Table 1-5 Dynamic equivalent load calculation : when a pair of single-row angular contact ball bearings or tapered roller bearings is arranged face-to-face or back-to-back.

Paired mounting		Loading condition	Bearing	Axial load	Dynamic equivalent load
Back-to-back arrangement	Face-to-face arrangement				
		$\frac{F_{rB}}{2Y_B} + K_a \geq \frac{F_{rA}}{2Y_A}$	Bearing A	$\frac{F_{rB}}{2Y_B} + K_a$	$P_A = XF_{rA} + Y_A \left( \frac{F_{rB}}{2Y_B} + K_a \right)$ $P_A = F_{rA}$ , where $P_A < F_{rA}$
			Bearing B	-	$P_B = F_{rB}$
		$\frac{F_{rB}}{2Y_B} + K_a < \frac{F_{rA}}{2Y_A}$	Bearing A	-	$P_A = F_{rA}$
			Bearing B	$\frac{F_{rA}}{2Y_A} - K_a$	$P_B = XF_{rB} + Y_B \left( \frac{F_{rA}}{2Y_A} - K_a \right)$ $P_B = F_{rB}$ , where $P_B < F_{rB}$
		$\frac{F_{rB}}{2Y_B} \leq \frac{F_{rA}}{2Y_A} + K_a$	Bearing A	-	$P_A = F_{rA}$
			Bearing B	$\frac{F_{rA}}{2Y_A} + K_a$	$P_B = XF_{rB} + Y_B \left( \frac{F_{rA}}{2Y_A} + K_a \right)$ $P_B = F_{rB}$ , where $P_B < F_{rB}$
		$\frac{F_{rB}}{2Y_B} > \frac{F_{rA}}{2Y_A} + K_a$	Bearing A	$\frac{F_{rB}}{2Y_B} - K_a$	$P_A = XF_{rA} + Y_A \left( \frac{F_{rB}}{2Y_B} - K_a \right)$ $P_A = F_{rA}$ , where $P_A < F_{rA}$
			Bearing B	-	$P_B = F_{rB}$

[Remarks] 1. These equations can be used when internal clearance and preload during operation are zero.  
2. Radial load is treated as positive in the calculation, if it is applied in a direction opposite that shown in Fig. in Table 1-5.

# 1. Selection of bearing dimensions

## 1-4-2 Mean dynamic equivalent load

When load magnitude or direction varies, it is necessary to calculate the mean dynamic equivalent load, which provides the same length

of bearing service life as that under the actual load fluctuation.

The mean dynamic equivalent load ( $P_m$ ) under different load fluctuations is described using Graphs (1) to (4).

(1) Staged fluctuation	(2) Stageless fluctuation
$P_m = \sqrt[p]{\frac{P_1^p n_1 t_1 + P_2^p n_2 t_2 + \dots + P_n^p n_n t_n}{n_1 t_1 + n_2 t_2 + \dots + n_n t_n}} \dots\dots\dots (1-12)$	$P_m = \frac{P_{min} + 2 P_{max}}{3} \dots\dots\dots (1-13)$
(3) Fluctuation forming sine curve	(4) Fluctuation forming sine curve (upper half of sine curve)
$P_m = 0.68 P_{max} \dots\dots\dots (1-14)$	$P_m = 0.75 P_{max} \dots\dots\dots (1-15)$

Symbols for Graphs (1) to (4)

$P_m$	: mean dynamic equivalent load	N
$P_1$	: dynamic equivalent load applied for $t_1$ hours at rotational speed $n_1$	N
$P_2$	: dynamic equivalent load applied for $t_2$ hours at rotational speed $n_2$	N
$\vdots$	$\vdots$	$\vdots$
$P_n$	: dynamic equivalent load applied for $t_n$ hours at rotational speed $n_n$	N
$P_{min}$	: minimum dynamic equivalent load	N
$P_{max}$	: maximum dynamic equivalent load	N
$\Sigma n_i t_i$	: total rotation in ( $t_1$ to $t_i$ ) hours	
$p$	: for ball bearings ..... $p = 3$	
	for roller bearings ..... $p = 10/3$	

[Reference] Mean rotational speed  $n_m$  can be calculated using the following equation :

$$n_m = \frac{n_1 t_1 + n_2 t_2 + \dots + n_n t_n}{t_1 + t_2 + \dots + t_n}$$

## 1-5 Basic static load rating and static equivalent load

### 1-5-1 Basic static load rating

Excessive static load or impact load even at very low rotation causes partial permanent deformation of the rolling element and raceway contacting surfaces. This permanent deformation increases with the load; if it exceeds a certain limit, smooth rotation will be hindered.

The basic static load rating is the static load which responds to the calculated contact stress shown below, at the contact center between the raceway and rolling elements which receive the maximum load.

- Self-aligning ball bearings ... 4 600 MPa
- Other ball bearings ..... 4 200 MPa
- Roller bearings ..... 4 000 MPa

The total extent of contact stress-caused permanent deformation on surfaces of rolling elements and raceway will be approximately 0.000 1 times greater than the rolling element diameter.

The basic static load rating for radial bearings is specified as **the basic static radial load rating**, and for thrust bearings, as **the basic static axial load rating**. These load ratings are listed in the bearing specification table, using  $C_{0r}$  and  $C_{0a}$  respectively.

These values are prescribed by ISO 78/1987 and are subject to change by conformance to the latest ISO standards.

### 1-5-2 Static equivalent load

The static equivalent load is a theoretical load calculated such that, during rotation at very low speed or when bearings are stationary, the same contact stress as that imposed under actual loading condition is generated at the contact center between raceway and rolling element to which the maximum load is applied.

For radial bearings, radial load passing through the bearing center is used for the calculation; for thrust bearings, axial load in a direction along the bearing axis is used.

The static equivalent load can be calculated using the following equations.

[Radial bearings]

...The greater value obtained by the following two equations is used.

$$P_{0r} = X_0 F_r + Y_0 F_a \dots\dots\dots (1-16)$$

$$P_{0r} = F_r \dots\dots\dots (1-17)$$

[Thrust bearings]

( $\alpha \neq 90^\circ$ )

$$P_{0a} = X_0 F_r + F_a \dots\dots\dots (1-18)$$

[When  $F_a < X_0 F_r$ , the solution becomes less accurate.]

( $\alpha = 90^\circ$ )

$$P_{0a} = F_a \dots\dots\dots (1-19)$$

where :

- $P_{0r}$  : static equivalent radial load N
  - $P_{0a}$  : static equivalent axial load N
  - $F_r$  : radial load N
  - $F_a$  : axial load N
  - $X_0$  : static radial load factor
  - $Y_0$  : static axial load factor
- (values of  $X_0$  and  $Y_0$  are listed in the bearing specification table.)



## 1. Selection of bearing dimensions

### 1-5-3 Safety coefficient

The allowable static equivalent load for a bearing is determined by the basic static load rating of the bearing; however, bearing service life, which is affected by permanent deformation, differs in accordance with the performance required of the bearing and operating conditions.

Therefore, a safety coefficient is designated, based on empirical data, so as to ensure safety in relation to basic static load rating.

$$f_s = \frac{C_0}{P_0} \dots\dots\dots (1-20)$$

where :  
 $f_s$  : safety coefficient (ref. Table 1-6)  
 $C_0$  : basic static load rating N  
 $P_0$  : static equivalent load N

**Table 1-6 Values of safety coefficient  $f_s$**

Operating condition		$f_s$ (min.)	
		Ball bearing	Roller bearing
With bearing rotation	When high running accuracy is required	2	3
	Normal operation	1	1.5
	When impact load is applied	1.5	3
Without bearing rotation (occasional oscillation)	Normal operation	0.5	1
	When impact load or uneven distribution load is applied	1	2

[Remark] For spherical thrust roller bearings,  $f_s \geq 4$ .

## 2. Bearing tolerances

Bearing tolerances and permissible values for the boundary dimensions and running accuracy of bearings are specified. These values are prescribed in JIS, ISO, ABMA, etc.

Bearing tolerances are classified into 6, 5, 4 etc., other than ordinary class 0. Class 0 bearings offer adequate performance for general applications, and bearings of class 5, 4, or higher are required for machine tools.

Table 2-1 shows the tolerance classes and JTEKT codes applied to the types of bearings shown in the dimensional tables.

Bearing tolerances of these bearings are shown in Tables 2-2 through 2-8. Table 2-9 shows the allowable limited values of chamfer dimensions, and Table 2-10 includes the tolerances for tapered bore.

**Table 2-1 Tolerance class for each bearing type**

Bearing type		Applied standards of tolerance class				Applied tolerance table
Deep groove ball bearing		JIS class 0	JIS class 6	JIS class 5	(JIS class 4)	Table 2-2
Angular contact ball bearing		JIS class 0	JIS class 6	JIS class 5	(JIS class 4)	
Cylindrical roller bearing		JIS class 0	JIS class 6	JIS class 5	(JIS class 4)	
Wide series cylindrical roller bearing		Equivalent to class 0	Equivalent to class 6	—	—	
Full complement cylindrical roller bearing		Equivalent to class 0	Equivalent to class 6	—	—	Table 2-3
Tapered roller bearing	Metric series (single-row)	JIS class 0, 6X	JIS class 6	JIS class 5	(JIS class 4)	
	Metric series (double or four-row)	BAS class 0	—	—	—	
	Metric series (J-series)	Class PK	Class PN	Class PC	(Class PB)	
Inch series		ABMA Class 4	ABMA Class 2	ABMA Class 3	(ABMA Class 0)	Table 2-5
Spherical roller bearing		JIS class 0	—	—	—	Table 2-2
Thrust ball bearing		JIS class 0	JIS class 6	(JIS class 5)	—	Table 2-7
Metric series tapered roller thrust bearing		Equivalent to class 0	—	—	—	Table 2-8
Spherical thrust roller bearing		JIS class 0	—	—	—	

[Remarks] 1. Products of tolerance classes included in parentheses shown in the table above are required, contact JTEKT.  
 2. Thrust tapered roller bearings for screw down, cylindrical roller bearings for multistage rolling mill back-up roll, and bearings for tunneling machine are manufactured with the special tolerances appropriate for their operating conditions.

2. Bearing tolerances

Table 2-2 (1) Radial bearing tolerances (tapered roller bearings excluded) = JIS B 1514 =

(1) Inner ring (bore diameter)

Unit :  $\mu\text{m}$

Nominal bore diameter $d$ mm		Single plane mean bore diameter deviation $\Delta_{dmp}$								Single bore diameter deviation $\Delta_{ds}^{(1)}$	Single plane bore diameter variation $V_{dsp}$								Mean bore diameter variation $V_{dmp}$				Nominal bore diameter $d$ mm						
		class 0		class 6		class 5		class 4			Diameter series 7, 8, 9				Diameter series 0, 1				Diameter series 2, 3, 4										
		upper	lower	upper	lower	upper	lower	upper	lower		upper	lower	upper	lower	upper	lower	upper	lower	upper	lower	upper	lower			upper	lower	upper	lower	over
30	50	0	-12	0	-10	0	-8	0	-6	0	-6	15	13	8	6	12	10	6	5	9	8	6	5	9	8	4	3	30	50
50	80	0	-15	0	-12	0	-9	0	-7	0	-7	19	15	9	7	19	15	7	5	11	9	7	5	11	9	5	3.5	50	80
80	120	0	-20	0	-15	0	-10	0	-8	0	-8	25	19	10	8	25	19	8	6	15	11	8	6	15	11	5	4	80	120
120	150	0	-25	0	-18	0	-13	0	-10	0	-10	31	23	13	10	31	23	10	8	19	14	10	8	19	14	7	5	120	150
150	180	0	-25	0	-18	0	-13	0	-10	0	-10	31	23	13	10	31	23	10	8	19	14	10	8	19	14	7	5	150	180
180	250	0	-30	0	-22	0	-15	0	-12	0	-12	38	28	15	12	38	28	12	9	23	17	12	9	23	17	8	6	180	250
250	315	0	-35	0	-25	0	-18	0	-15	0	-15	44	31	18	15	44	31	14	11	26	19	14	11	26	19	9	8	250	315
315	400	0	-40	0	-30	0	-23	0	-18	0	-18	50	38	23	18	50	38	18	14	30	23	18	14	30	23	12	9	315	400
400	500	0	-45	0	-35	0	-28	0	-23	0	-23	56	44	28	23	56	44	21	17	34	26	21	17	34	26	14	12	400	500
500	630	0	-50	0	-40	0	-35	-	-	-	-	63	50	35	-	63	50	26	-	38	30	26	-	38	30	18	-	500	630
630	800	0	-75	0	-50	0	-45	-	-	-	-	94	63	45	-	94	63	34	-	56	38	34	-	56	38	23	-	630	800
800	1 000	0	-100	0	-60	0	-60	-	-	-	-	125	75	60	-	125	75	45	-	75	45	45	-	75	45	30	-	800	1 000
1 000	1 250	0	-125	0	-75	0	-75	-	-	-	-	156	94	75	-	156	94	56	-	94	56	56	-	94	56	38	-	1 000	1 250
1 250	1 600	0	-160	-	-	-	-	-	-	-	-	200	-	-	-	200	-	-	-	120	-	-	-	120	-	-	-	1 250	1 600
1 600	2 000	0	-200	-	-	-	-	-	-	-	-	250	-	-	-	250	-	-	-	150	-	-	-	150	-	-	-	1 600	2 000

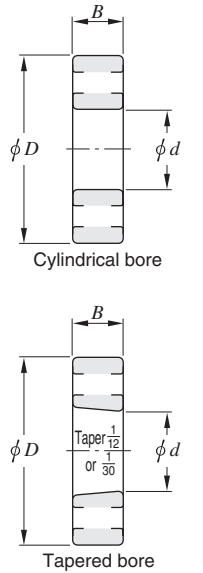

(2) Inner ring (running accuracy and width)

Unit :  $\mu\text{m}$

Nominal bore diameter $d$ mm		Radial runout of assembled bearing inner ring $K_{ia}$				$S_d$				$S_{ia}^{(2)}$				Single inner ring width deviation $\Delta_{Bs}$								Matched pair inner ring width deviation $\Delta_{Bs}^{(3)}$								Inner ring width variation $V_{Bs}$				Nominal bore diameter $d$ mm	
		class 0		class 6		class 5		class 4		class 5		class 4		class 0				class 6				class 5				class 4									
		upper	lower	upper	lower	upper	lower	upper	lower	upper	lower	upper	lower	upper	lower	upper	lower	upper	lower	upper	lower	upper	lower	upper	lower	upper	lower	upper	lower	over	up to				
30	50	15	10	5	4	8	4	8	4	0	-120	0	-120	0	-120	0	-120	0	-250	0	-250	0	-250	0	-250	0	-250	20	20	5	3	30	50		
50	80	20	10	5	4	8	5	8	5	0	-150	0	-150	0	-150	0	-150	0	-380	0	-380	0	-380	0	-380	0	-380	25	25	6	4	50	80		
80	120	25	13	6	5	9	5	9	5	0	-200	0	-200	0	-200	0	-200	0	-380	0	-380	0	-380	0	-380	0	-380	25	25	7	4	80	120		
120	150	30	18	8	6	10	6	10	7	0	-250	0	-250	0	-250	0	-250	0	-500	0	-500	0	-500	0	-500	0	-500	30	30	8	5	120	150		
150	180	30	18	8	6	10	6	10	7	0	-250	0	-250	0	-250	0	-250	0	-500	0	-500	0	-500	0	-500	0	-500	30	30	8	5	150	180		
180	250	40	20	10	8	11	7	13	8	0	-300	0	-300	0	-300	0	-300	0	-500	0	-500	0	-500	0	-500	0	-500	30	30	10	6	180	250		
250	315	50	25	13	10	13	8	15	9	0	-350	0	-350	0	-350	0	-350	0	-500	0	-500	0	-500	-	-	-	-	35	35	13	8	250	315		
315	400	60	30	15	13	15	9	20	12	0	-400	0	-400	0	-400	0	-400	0	-630	0	-630	0	-630	-	-	-	-	40	40	15	9	315	400		
400	500	65	35	20	15	18	11	25	15	0	-450	0	-450	0	-450	0	-450	0	-500	0	-500	0	-500	-	-	-	-	50	45	18	11	400	500		
500	630	70	40	25	-	25	-	30	-	0	-500	0	-500	0	-500	0	-500	0	-500	0	-500	0	-500	-	-	-	-	60	50	20	-	500	630		
630	800	80	50	30	-	30	-	35	-	0	-750	0	-750	0	-750	0	-750	0	-750	0	-750	0	-750	-	-	-	-	70	60	23	-	630	800		
800	1 000	90	60	40	-	40	-	45	-	0	-1 000	0	-1 000	0	-1 000	0	-1 000	0	-1 000	0	-1 000	0	-1 000	-	-	-	-	80	60	35	-	800	1 000		
1 000	1 250	100	70	50	-	50	-	60	-	0	-1 250	0	-1 250	0	-1 250	0	-1 250	0	-1 250	0	-1 250	0	-1 250	-	-	-	-	100	60	45	-	1 000	1 250		
1 250	1 600	120	-	-	-	-	-	-	-	0	-1 600	-	-	-	-	-	-	-	-	-	-	-	-	-	-	-	-	120	-	-	-	1 250	1 600		
1 600	2 000	140	-	-	-	-	-	-	-	0	-2 000	-	-	-	-	-	-	-	-	-	-	-	-	-	-	-	-	140	-	-	-	1 600	2 000		

$S_d$  : Perpendicularity of inner ring face with respect to the bore  $S_{ia}$  : Axial runout of assembled bearing inner ring

- [Notes] 1) These shall be applied to bearings of diameter series 0, 1, 2, 3 and 4.  
 2) These shall be applied to deep groove ball bearings and angular contact ball bearings.  
 3) These shall be applied to individual bearing rings manufactured for matched pair or stack bearings.

4) Also applicable to the inner ring with tapered bore of  $d \geq 50$  mm.

[Remark] Values in Italics are prescribed in JTEKT standards.

2. Bearing tolerances

Table 2-2 (2) Radial bearing tolerances (tapered roller bearings excluded)  
(3) Outer ring (outside diameter)

Unit :  $\mu\text{m}$

Nominal outside dia. $D$ mm		Single plane mean outside diameter deviation								Single outside diameter deviation $\Delta D_s^{(1)}$	Single plane outside diameter variation $V_{Dsp}$												Mean outside diameter variation				Nominal outside dia. $D$ mm				
		$\Delta D_{mp}$									Diameter series 7, 8, 9				Diameter series 0, 1				Diameter series 2, 3, 4				$V_{Dmp}$								
		class 0		class 6		class 5		class 4			class 4 <sup>(5)</sup>		class 0 <sup>(2)</sup>	class 6 <sup>(2)</sup>	class 5 <sup>(5)</sup>	class 4 <sup>(5)</sup>	Class 0 <sup>(2)</sup>	Class 6 <sup>(2)</sup>	Class 5 <sup>(5)</sup>	Class 4 <sup>(5)</sup>	Class 0 <sup>(2)</sup>	Class 6 <sup>(2)</sup>	Class 0 <sup>(2)</sup>	Class 6 <sup>(2)</sup>	Class 5	Class 4					
		upper	lower	upper	lower	upper	lower	upper	lower		upper	lower	max.				max.				max.				max.						
over	up to																									over	up to				
50	80	0	-13	0	-11	0	-9	0	-7	0	-7	16	14	9	7	13	11	7	5	10	8	7	5	20	16	10	8	5	3.5	50	80
80	120	0	-15	0	-13	0	-10	0	-8	0	-8	19	16	10	8	19	16	8	6	11	10	8	6	26	20	11	10	5	4	80	120
120	150	0	-18	0	-15	0	-11	0	-9	0	-9	23	19	11	9	23	19	8	7	14	11	8	7	30	25	14	11	6	5	120	150
150	180	0	-25	0	-18	0	-13	0	-10	0	-10	31	23	13	10	31	23	10	8	19	14	10	8	38	30	19	14	7	5	150	180
180	250	0	-30	0	-20	0	-15	0	-11	0	-11	38	25	15	11	38	25	11	8	23	15	11	8	-	-	23	15	8	6	180	250
250	315	0	-35	0	-25	0	-18	0	-13	0	-13	44	31	18	13	44	31	14	10	26	19	14	10	-	-	26	19	9	7	250	315
315	400	0	-40	0	-28	0	-20	0	-15	0	-15	50	35	20	15	50	35	15	11	30	21	15	11	-	-	30	21	10	8	315	400
400	500	0	-45	0	-33	0	-23	0	-17	0	-17	56	41	23	17	56	41	17	13	34	25	17	13	-	-	34	25	12	9	400	500
500	630	0	-50	0	-38	0	-28	0	-20	0	-20	63	48	28	20	63	48	21	15	38	29	21	15	-	-	38	29	14	10	500	630
630	800	0	-75	0	-45	0	-35	-	-	-	-	94	56	35	-	94	56	26	-	55	34	26	-	-	-	55	34	18	-	630	800
800	1 000	0	-100	0	-60	0	-50	-	-	-	-	125	75	50	-	125	75	38	-	75	45	38	-	-	-	75	45	25	-	800	1 000
1 000	1 250	0	-125	0	-75	0	-63	-	-	-	-	156	94	63	-	156	94	47	-	94	56	47	-	-	-	94	56	31	-	1 000	1 250
1 250	1 600	0	-160	0	-90	0	-80	-	-	-	-	200	113	80	-	200	113	60	-	120	68	60	-	-	-	120	68	40	-	1 250	1 600
1 600	2 000	0	-200	0	-120	0	-100	-	-	-	-	250	150	-	-	250	150	-	-	150	90	-	-	-	-	150	90	-	-	1 600	2 000
2 000	2 500	0	-250	-	-	-	-	-	-	-	-	313	-	-	-	313	-	-	-	188	-	-	-	-	-	188	-	-	-	2 000	2 500

(4) Outer ring (running accuracy and width)

Unit :  $\mu\text{m}$

Nominal outside dia. $D$ mm		Radial runout of assembled bearing outer ring				$S_D^{(4)}$		$S_{ea}^{(3)(4)}$		$\Delta C_s^{(3)}$		Outer ring width variation		
		$K_{ea}$				class 5		class 4		classes 0, 6, 5, 4		$V_{Cs}^{(3)}$		
		class 0	class 6	class 5	class 4	class 5	class 4	class 5	class 4	classes 0, 6	class 5	class 4	max.	
over	up to	max.				max.		max.		upper	lower	max.		
50	80	25	13	8	5	8	4	10	5	-	-	6	3	
80	120	35	18	10	6	9	5	11	6	-	-	8	4	
120	150	40	20	11	7	10	5	13	7	-	-	8	5	
150	180	45	23	13	8	10	5	14	8	-	-	8	5	
180	250	50	25	15	10	11	7	15	10	-	-	10	7	
250	315	60	30	18	11	13	8	18	10	-	-	11	7	
315	400	70	35	20	13	13	10	20	13	-	-	13	8	
400	500	80	40	23	15	15	12	23	15	-	-	15	9	
500	630	100	50	25	18	18	13	25	18	-	-	18	11	
630	800	120	60	30	-	20	-	30	-	-	-	20	-	
800	1 000	140	75	40	-	23	-	40	-	-	-	23	-	
1 000	1 250	160	85	45	-	30	-	45	-	-	-	30	-	
1 250	1 600	190	95	60	-	45	-	60	-	-	-	45	-	
1 600	2 000	220	110	-	-	-	-	-	-	-	-	-	-	
2 000	2 500	250	-	-	-	-	-	-	-	-	-	-	-	

$S_D$  : Perpendicularity of outer ring outside surface with respect to the face

$S_{ea}$  : Axial runout of assembled bearing outer ring

$\Delta C_s$  : Deviation of a single outer ring width

[Notes]

- 1) These shall be applied to bearings of diameter series 0, 1, 2, 3 and 4.
- 2) Shall be applied when locating snap ring is not fitted.
- 3) These shall be applied to deep groove ball bearings and angular contact ball bearings.
- 4) These shall not be applied to flanged bearings.
- 5) These shall not be applied to shielded bearings and sealed bearings.

[Remark]

Values in Italics are prescribed in JTEKT standards.

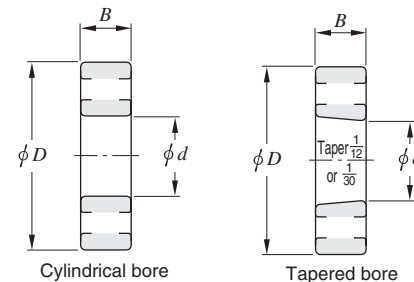

$d$  : nominal bore diameter  
 $D$  : nominal outside diameter  
 $B$  : nominal assembled bearing width

2. Bearing tolerances

Table 2-3 (1) Tolerances for metric series tapered roller bearings = JIS B 1514 =

(1) Inner ring

Unit :  $\mu\text{m}$

Nominal bore diameter $d$ mm		Single plane mean bore diameter deviation $\Delta_{dmp}$						Single bore diameter deviation $\Delta_{ds}$		Single plane bore diameter variation $V_{dsp}$				Mean bore diameter variation $V_{dmp}$				Radial runout of assembled bearing inner ring $K_{ia}$				$S_d$		$S_{ia}$		Single inner ring width deviation $\Delta_{Bs}$						Nominal bore diameter $d$ mm					
		classes 0, 6X		classes 6, 5		class 4		class 4		classes 0, 6X		class 6		class 5		class 4		classes 0, 6X		class 6		class 5		class 4		class 4		class 0		class 6X				class 6		classes 5, 4	
		upper	lower	upper	lower	upper	lower	upper	lower	upper	lower	max.	max.	max.	max.	max.	max.	max.	max.	max.	max.	max.	max.	max.	max.	max.	upper	lower	upper	lower	upper			lower	upper	lower	over
over	up to	upper	lower	upper	lower	upper	lower	upper	lower	max.				max.				max.				max.		max.		max.		upper	lower	upper	lower	upper	lower	upper	lower	over	up to
80	120	0	-20	0	-15 <sup>2)</sup>	0	-10	0	-10	20	15	11	8	15	11	8	5	30	13	8	5	9	5	5	5	0	-200	0	-50	0	-200	0	-400	80	120		
120	180	0	-25	0	-18 <sup>2)</sup>	0	-13	0	-13	25	18	14	10	19	14	9	7	35	18	11	6	10	6	7	7	0	-250	0	-50	0	-250	0	-500	120	180		
180	250	0	-30	0	-22 <sup>2)</sup>	0	-15	0	-15	30	22	17	11	23	16	11	8	50	20	13	8	11	7	8	8	0	-300	0	-50	0	-300	0	-600	180	250		
250	315	0	-35	0	-25	0	-18	0	-18	35	25	19	12	26	19	13	9	60	30	13	9	13	8	9	9	0	-350	0	-50	0	-350	0	-700	250	315		
315	400	0	-40	0	-30	-	-	-	-	40	30	23	-	30	23	15	-	70	35	15	-	15	-	-	-	0	-400	0	-50	0	-400	0	-800 <sup>3)</sup>	315	400		
400	500	0	-45	0	-35	-	-	-	-	45	35	28	-	34	26	17	-	80	40	20	-	17	-	-	-	0	-450	0	-50	0	-450	0	-900 <sup>3)</sup>	400	500		
500	630	0	-60	0	-40	-	-	-	-	60	40	35	-	40	30	20	-	90	50	25	-	20	-	-	-	0	-500	-	-	0	-500	0	-1 100 <sup>3)</sup>	500	630		
630	800	0	-75	0	-50	-	-	-	-	75	50	45	-	45	38	25	-	100	60	30	-	25	-	-	-	0	-750	-	-	0	-750	0	-1 600 <sup>3)</sup>	630	800		
800	1 000	0	-100	0	-60	-	-	-	-	100	60	60	-	55	45	30	-	115	75	37	-	30	-	-	-	0	-1 000	-	-	0	-1 000	0	-2 000 <sup>3)</sup>	800	1 000		
1 000	1 250	0	-125	0	-75	-	-	-	-	125	75	56	-	94 <sup>1)</sup>	56	38	-	120 <sup>1)</sup>	85	28	-	30	-	-	-	0	-1 250	-	-	0	-1 250	0	-2 500 <sup>3)</sup>	1 000	1 250		
1 250	1 600	0	-160	0	-90	-	-	-	-	160	-	-	-	120 <sup>1)</sup>	-	-	-	120 <sup>1)</sup>	-	-	-	-	-	-	-	0	-1 600	-	-	-	-	-	-	1 250	1 600		
1 600	2 000	0	-200	-	-	-	-	-	-	200	-	-	-	150 <sup>1)</sup>	-	-	-	140 <sup>1)</sup>	-	-	-	-	-	-	-	0	-2 000	-	-	-	-	-	-	1 600	2 000		

$S_d$  : Perpendicularity of inner ring face with respect to the bore,  $S_{ia}$  : Axial runout of assembled bearing inner ring

(2-1) Outer ring

Unit :  $\mu\text{m}$

Nominal outside diameter $D$ mm		Single plane mean outside diameter deviation $\Delta_{Dmp}$						Single outside diameter deviation $\Delta_{Ds}$		Single plane outside diameter variation $V_{Dsp}$				Mean outside diameter variation $V_{Dmp}$				Radial runout of assembled bearing outer ring $K_{ea}$				$S_D^{4)}$		$S_{ea}^{4)}$		Nominal outside diameter $D$ mm			
		classes 0, 6X		classes 6, 5		class 4		class 4		classes 0, 6X		class 6		class 5		class 4		classes 0, 6X		class 6		class 5		class 4		class 4		over	up to
		upper	lower	upper	lower	upper	lower	upper	lower	upper	lower	max.	max.	max.	max.	max.	max.	max.	max.	max.	max.	max.	max.	max.	max.	max.	over	up to	
80	120	0	-18	0	-13 <sup>2)</sup>	0	-10	0	-10	18	13	10	8	14	10	7	5	35	18	10	6	9	5	6	6	80	120		
120	150	0	-20	0	-15 <sup>2)</sup>	0	-11	0	-11	20	15	11	8	15	11	8	6	40	20	11	7	10	5	7	7	120	150		
150	180	0	-25	0	-18 <sup>2)</sup>	0	-13	0	-13	25	18	14	10	19	14	9	7	45	23	13	8	10	5	8	8	150	180		
180	250	0	-30	0	-20 <sup>2)</sup>	0	-15	0	-15	30	20	15	11	23	15	10	8	50	25	15	10	11	7	10	10	180	250		
250	315	0	-35	0	-25 <sup>2)</sup>	0	-18	0	-18	35	25	19	14	26	19	13	9	60	30	18	11	13	8	10	10	250	315		
315	400	0	-40	0	-28 <sup>2)</sup>	0	-20	0	-20	40	28	22	15	30	21	14	10	70	35	20	13	13	10	13	13	315	400		
400	500	0	-45	0	-33	-	-	-	-	45	33	26	-	34	25	17	-	80	40	24	-	17	-	-	-	400	500		
500	630	0	-50	0	-38	-	-	-	-	60	38	30	-	38	29	20	-	100	50	30	-	20	-	-	-	500	630		
630	800	0	-75	0	-45	-	-	-	-	80	45	38	-	55	34	25	-	120	60	36	-	25	-	-	-	630	800		
800	1 000	0	-100	0	-60	-	-	-	-	100	60	50	-	75	45	30	-	140	75	43	-	30	-	-	-	800	1 000		
1 000	1 250	0	-125	0	-80	-	-	-	-	130	75	65	-	90	56	38	-	160	85	52	-	38	-	-	-	1 000	1 250		
1 250	1 600	0	-160	0	-100	-	-	-	-	170	90	90	-	100	68	50	-	180	95	62	-	50	-	-	-	1 250	1 600		
1 600	2 000	0	-200	0	-120	-	-	-	-	200 <sup>1)</sup>	120	90	-	150 <sup>1)</sup>	90	60	-	220 <sup>1)</sup>	115	45	-	40	-	-	-	1 600	2 000		

- [Notes] 1) These shall be applied to bearing of tolerance class 0.  
 2) These shall be applied to bearing of tolerance class 6.  
 3) These shall be applied to bearing of tolerance class 5.  
 4) These shall not be applied to flanged bearings.

$S_D$  : Perpendicularity of outer ring outside surface with respect to the face  
 $S_{ea}$  : Axial runout of assembled bearing outer ring

(2-2) Outer ring Unit :  $\mu\text{m}$

Nominal bore diameter $d$ mm		Single outer ring width deviation $\Delta_{Cs}$				Nominal outside diameter $D$ mm	
		class 6X <sup>4)</sup>		classes 0, 6, 5, 4			
		upper	lower	upper	lower		
over	up to	upper	lower	upper	lower	over	up to
80	120	0	-100	-	-	80	120
120	180	0	-100	-	-	120	180
180	250	0	-100	-	-	180	250
250	315	0	-100	-	-	250	315
315	400	0	-100	-	-	315	400
400	500	0	-100	-	-	400	500
500	630	-	-	-	-	500	630
630	800	-	-	-	-	630	800
800	1 000	-	-	-	-	800	1 000

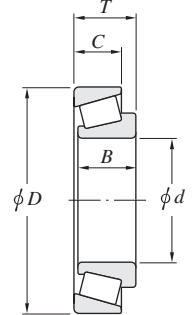

$d$  : nominal bore diameter  
 $D$  : nominal outside diameter  
 $B$  : nominal inner ring width  
 $C$  : nominal outer ring width  
 $T$  : nominal assembled bearing width

[Remark] Values in Italics are prescribed in JTEKT standards.

2. Bearing tolerances

Table 2-3 (2) Tolerances for metric series tapered roller bearings

(3) Assembled bearing width and effective width

Unit :  $\mu\text{m}$

Nominal bore diameter $d$ mm	Actual bearing width deviation $\Delta T_s$								Actual effective inner sub-unit width deviation $\Delta T_{1s}$							
	class 0		class 6X		class 6		classes 5, 4		class 0		class 6X		classes 5, 4			
	upper	lower	upper	lower	upper	lower	upper	lower	upper	lower	upper	lower	upper	lower		
80	120	+200	-200	+100	0	+200	-200	+200	-200	+100	-100	+ 50	0	+100	-100	
120	180	+350	-250	+150	0	+350	-250	+350	-250	+150	-150	+ 50	0	+150	-150	
180	250	+350	-250	+150	0	+350	-250	+350	-250	+150	-150	+ 50	0	+150	-150	
250	315	+350	-250	+200	0	+350	-250	+350	-250	+150	-150	+100	0	+150	-150	
315	400	+400	-400	+200	0	+400	-400	+400	-400 <sup>1)</sup>	+200	-200	+100	0	+200	-200 <sup>1)</sup>	
400	500	+450	-450	+200	0	+400	-400	+450	-450 <sup>1)</sup>	+225	-225	+100	0	+225	-225 <sup>1)</sup>	
500	630	+500	-500	-	-	+500	-500	+500	-500 <sup>1)</sup>	-	-	-	-	-	-	
630	800	+600	-600	-	-	+600	-600	+600	-600 <sup>1)</sup>	-	-	-	-	-	-	
800	1 000	+750	-750	-	-	+750	-750	+750	-750 <sup>1)</sup>	-	-	-	-	-	-	

Nominal bore diameter $d$ mm	Actual effective outer ring width deviation $\Delta r_{2s}$								
	class 0		class 6X		classes 5, 4				
	upper	lower	upper	lower	upper	lower	upper	lower	
80	120	+100	-100	+ 50	0	+100	-100		
120	180	+200	-100	+100	0	+200	-100		
180	250	+200	-100	+100	0	+200	-100		
250	315	+200	-100	+100	0	+200	-100		
315	400	+200	-200	+100	0	+200	-200 <sup>1)</sup>		
400	500	+225	-225	+100	0	+225	-225 <sup>1)</sup>		
500	630	-	-	-	-	-	-		
630	800	-	-	-	-	-	-		
800	1 000	-	-	-	-	-	-		

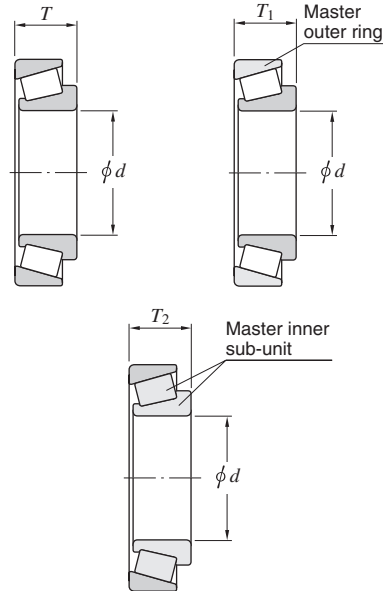

$d$  : nominal bore diameter  
 $T$  : nominal assembled bearing width  
 $T_1$  : nominal effective width of inner sub-unit  
 $T_2$  : nominal effective width of outer ring

[Note] 1) These shall be applied to bearings of tolerance class 5.  
 [Remark] Values in Italics are prescribed in JTEKT standards.

Table 2-4 Tolerances for metric series double-row and four-row tapered roller bearings (class 0)

= BAS 1002 =

(1) Inner ring, outer ring width and overall width

Unit :  $\mu\text{m}$

Nominal bore diameter $d$ mm	Single plane mean bore diameter deviation $\Delta d_{mp}$	$V_{dsp}$	$V_{dmp}$	$K_{ia}$	Single outer ring or inner ring width deviation $\Delta B_s, \Delta C_s$	Actual overall inner rings / outer rings width deviation						
						Double-row $\Delta T_s$		Four-row $\Delta T_s, \Delta W_s$				
						upper	lower	upper	lower			
over	up to	upper	lower	max.	max.	max.	upper	lower	upper	lower		
50	80	0	- 15	15	11	25	0	- 150	+ 300	- 300	-	-
80	120	0	- 20	20	15	30	0	- 200	+ 400	- 400	+ 500	- 500
120	180	0	- 25	25	19	35	0	- 250	+ 500	- 500	+ 600	- 600
180	250	0	- 30	30	23	50	0	- 300	+ 600	- 600	+ 750	- 750
250	315	0	- 35	35	26	60	0	- 350	+ 700	- 700	+ 900	- 900
315	400	0	- 40	40	30	70	0	- 400	+ 800	- 800	+1 000	-1 000
400	500	0	- 45	45	34	80	0	- 450	+ 900	- 900	+1 200	-1 200
500	630	0	- 60	60	40	90	0	- 500	+1 000	-1 000	+1 200	-1 200
630	800	0	- 75	75	45	100	0	- 750	+1 500	-1 500	-	-
800	1 000	0	-100	100	55	115	0	-1 000	+1 500	-1 500	-	-

$V_{dsp}$  : Single plane bore diameter variation,  $V_{dmp}$  : Mean bore diameter variation  
 $K_{ia}$  : Radial runout of assembled bearing inner ring

(2) Outer ring Unit :  $\mu\text{m}$

Nominal outside diameter $D$ mm	Single plane mean outside diameter deviation $\Delta D_{mp}$	$V_{Dsp}$	$V_{Dmp}$	$K_{ea}$							
					over	up to	upper	lower	max.	max.	max.
					80	120	0	- 18	18	14	35
120	150	0	- 20	20	15	40					
150	180	0	- 25	25	19	45					
180	250	0	- 30	30	23	50					
250	315	0	- 35	35	26	60					
315	400	0	- 40	40	30	70					
400	500	0	- 45	45	34	80					
500	630	0	- 50	60	38	100					
630	800	0	- 75	80	55	120					
800	1 000	0	-100	100	75	140					
1 000	1 250	0	-125	130	90	160					
1 250	1 600	0	-160	170	100	180					

$V_{Dsp}$  : Single plane outside diameter variation  
 $V_{Dmp}$  : Mean outside diameter variation  
 $K_{ea}$  : Radial runout of assembled bearing outer ring

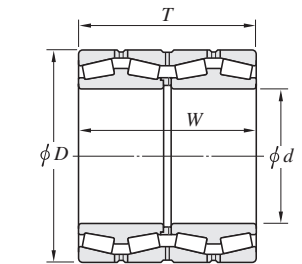
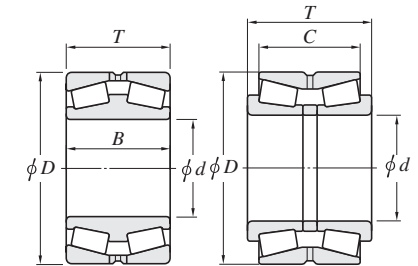

$d$  : nominal bore diameter  
 $D$  : nominal outside diameter  
 $B$  : nominal double inner ring width  
 $C$  : nominal double outer ring width  
 $T, W$  : nominal overall width of outer rings (inner rings)

2. Bearing tolerances

Table 2-5 Tolerances for inch series tapered roller bearings = ABMA 19 =

(1) Inner ring Unit : μm

Applied bearing type	Nominal bore diameter $d$ , mm (1/25.4)		Deviation of a single bore diameter $\Delta_{ds}$							
			Class 4		Class 2		Class 3		Class 0	
	over	up to	upper	lower	upper	lower	upper	lower	upper	lower
All types	-	76.2 ( 3.0)	+ 13	0	+13	0	+13	0	+13	0
	76.2 ( 3.0)	266.7 (10.5)	+ 25	0	+25	0	+13	0	+13	0
	266.7 (10.5)	304.8 (12.0)	+ 25	0	+25	0	+13	0	+13	0
	304.8 (12.0)	609.6 (24.0)	+ 51	0	+51	0	+25	0	-	-
	609.6 (24.0)	914.4 (36.0)	+ 76	0	-	-	+38	0	-	-
	914.4 (36.0)	1 219.2 (48.0)	+102	0	-	-	+51	0	-	-
	1 219.2 (48.0)	-	+127	0	-	-	+76	0	-	-

(2) Outer ring Unit : μm

Applied bearing type	Nominal outside diameter $D$ , mm (1/25.4)		Deviation of a single outside diameter $\Delta_{Ds}$							
			Class 4		Class 2		Class 3		Class 0	
	over	up to	upper	lower	upper	lower	upper	lower	upper	lower
All types	-	266.7 (10.5)	+ 25	0	+25	0	+13	0	+13	0
	266.7 (10.5)	304.8 (12.0)	+ 25	0	+25	0	+13	0	+13	0
	304.8 (12.0)	609.6 (24.0)	+ 51	0	+51	0	+25	0	-	-
	609.6 (24.0)	914.4 (36.0)	+ 76	0	+76	0	+38	0	-	-
	914.4 (36.0)	1 219.2 (48.0)	+102	0	-	-	+51	0	-	-
		1 219.2 (48.0)	-	+127	0	-	-	+76	0	-

(3) Radial runout of assembled bearing inner ring / outer ring Unit : μm

Applied bearing type	Nominal outside diameter $D$ , mm (1/25.4)		Radial runout of inner ring / outer ring $K_{ia}$ , $K_{ea}$			
			Class 4	Class 2	Class 3	Class 0
	over	up to	max.	max.	max.	max.
All types	-	266.7 (10.5)	51	38	8	4
	266.7 (10.5)	304.8 (12.0)	51	38	8	4
	304.8 (12.0)	609.6 (24.0)	51	38	18	-
	609.6 (24.0)	914.4 (36.0)	76	51	51	-
	914.4 (36.0)	1 219.2 (48.0)	76	-	76	-
		1 219.2 (48.0)	76	-	76	-

(4) Assembled bearing width and overall width Unit : μm

Applied bearing type	Nominal bore diameter $d$ , mm (1/25.4)		Nominal outside diameter $D$ , mm (1/25.4)		Deviation of the actual bearing width and overall width of inner rings / outer rings $\Delta_{Ts}$ , $\Delta_{Ws}$							
					Class 4		Class 2		Class 3		Class 0	
	over	up to	over	up to	upper	lower	upper	lower	upper	lower	upper	lower
Single-row	-	101.6 ( 4.0)	-	-	+ 203	0	+ 203	0	+ 203	- 203	+ 203	- 203
	101.6 ( 4.0)	266.7 (10.5)	-	-	+ 356	- 254	+ 203	0	+ 203	- 203	+ 203	- 203
	266.7 (10.5)	304.8 (12.0)	-	-	+ 356	- 254	+ 203	0	+ 203	- 203	+ 203	- 203
	304.8 (12.0)	609.6 (24.0)	-	508.0 (20.0)	-	-	+ 381	- 381	+ 203	- 203	-	-
	304.8 (12.0)	609.6 (24.0)	508.0 (20.0)	-	-	-	+ 381	- 381	+ 381	- 381	-	-
	609.6 (24.0)	-	-	-	+ 381	- 381	-	-	+ 381	- 381	-	-
Double-row	-	101.6 ( 4.0)	-	-	+ 406	0	+ 406	0	+ 406	- 406	+ 406	- 406
	101.6 ( 4.0)	266.7 (10.5)	-	-	+ 711	- 508	+ 406	- 203	+ 406	- 406	+ 406	- 406
	266.7 (10.5)	304.8 (12.0)	-	-	+ 711	- 508	+ 406	- 203	+ 406	- 406	+ 406	- 406
	304.8 (12.0)	609.6 (24.0)	-	508.0 (20.0)	-	-	+ 762	- 762	+ 406	- 406	-	-
	304.8 (12.0)	609.6 (24.0)	508.0 (20.0)	-	-	-	+ 762	- 762	+ 762	- 762	-	-
	609.6 (24.0)	-	-	-	+ 762	- 762	-	-	+ 762	- 762	-	-
Double-row (TNA type)	-	127.0 ( 5.0)	-	-	-	-	+ 254	0	+ 254	0	-	-
	127.0 ( 5.0)	-	-	-	-	-	+ 762	0	+ 762	0	-	-
Four-row	Total dimensional range		-	-	+1 524	-1 524	+1 524	-1 524	+1 524	-1 524	+1 524	-1 524

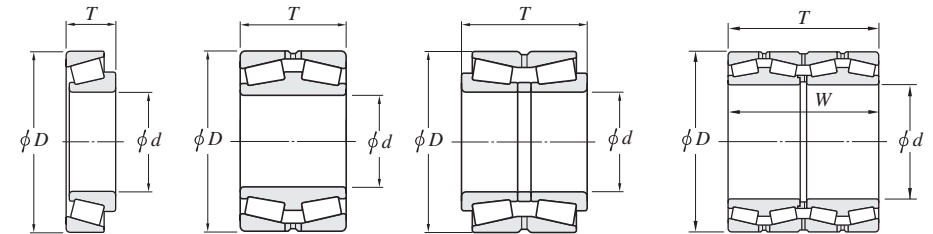

$d$  : nominal bore diameter  
 $D$  : nominal outside diameter  
 $T, W$  : nominal assembled bearing width and nominal overall width of outer rings (inner rings)

2. Bearing tolerances

Table 2-6 Tolerances for metric J series tapered roller bearings<sup>1)</sup>

(1) Bore diameter and width of inner ring and assembled bearing width

Unit : μm

Nominal bore diameter <i>d</i> mm		Deviation of a single bore diameter $\Delta_{ds}$								Deviation of a single inner ring width $\Delta_{Bs}$								Deviation of the actual bearing width $\Delta_{Ts}$								Nominal bore diameter <i>d</i> mm	
		Class PK		Class PN		Class PC		Class PB		Class PK		Class PN		Class PC		Class PB		Class PK		Class PN		Class PC		Class PB			
over	up to	upper	lower	upper	lower	upper	lower	upper	lower	upper	lower	upper	lower	upper	lower	upper	lower	upper	lower	upper	lower	upper	lower	upper	lower	over	up to
80	120	0	-20	0	-20	0	-15	0	-10	0	-150	0	-50	0	-300	0	-300	+200	-200	+100	0	+200	-200	+200	-200	80	120
120	180	0	-25	0	-25	0	-18	0	-13	0	-200	0	-50	0	-300	0	-300	+350	-250	+150	0	+350	-250	+200	-250	120	180
180	250	0	-30	0	-30	0	-22	0	-15	0	-200	0	-50	0	-350	0	-350	+350	-250	+150	0	+350	-250	+200	-300	180	250
250	315	0	-35	0	-35	0	-22	0	-15	0	-200	0	-50	0	-350	0	-350	+350	-250	+200	0	+350	-300	+200	-300	250	315

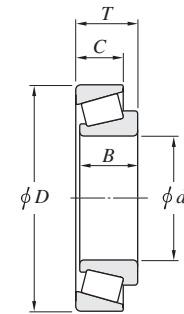

*d* : nominal bore diameter  
*D* : nominal outside diameter  
*B* : nominal inner ring width  
*C* : nominal outer ring width  
*T* : nominal assembled bearing width

(2) Outside diameter and width of outer ring and radial runout of assembled bearing inner ring / outer ring

Unit : μm

Nominal outside diameter <i>D</i> mm		Deviation of a single outside diameter $\Delta_{Ds}$								Deviation of a single outer ring width $\Delta_{Cs}$								Radial runout of inner ring / outer ring $K_{ia}, K_{ea}$				Nominal outside diameter <i>D</i> mm	
		Class PK		Class PN		Class PC		Class PB		Class PK		Class PN		Class PC		Class PB		Class PK	Class PN	Class PC	Class PB		
over	up to	upper	lower	upper	lower	upper	lower	upper	lower	upper	lower	upper	lower	upper	lower	upper	lower	upper	lower	upper	lower	over	up to
120	150	0	-20	0	-20	0	-15	0	-11	0	-200	0	-100	0	-200	0	-200	max.	max.	max.	max.	120	150
150	180	0	-25	0	-25	0	-18	0	-13	0	-200	0	-100	0	-250	0	-250	45	45	8	4	150	180
180	250	0	-30	0	-30	0	-20	0	-15	0	-250	0	-100	0	-250	0	-250	50	50	10	5	180	250
250	315	0	-35	0	-35	0	-25	0	-18	0	-250	0	-100	0	-300	0	-300	60	60	11	5	250	315
315	400	0	-40	0	-40	0	-28	-	-	0	-250	0	-100	0	-300	-	-	70	70	13	-	315	400

[Note] 1) Bearings with supplementary code "J" attached at the front of bearing number.

Ex. JHM720249/JHM720210, and the like

2. Bearing tolerances

Table 2-7 Tolerances for thrust ball bearings = JIS B 1514 =

(1) Shaft washer

Unit :  $\mu\text{m}$

Nominal bore diameter $d$ mm		Single plane mean bore diameter deviation $\Delta_{dmp}$		Single plane bore diameter variation $V_{dsp}$	Washer raceway to back face thickness variation $S_i^{1)}$			Deviation of the actual bearing height $\Delta_{Ts}$	
		classes 0, 6, 5			class 0	class 6	class 5	classes 0, 6, 5	
		over	up to	upper	lower	max.			upper
80	120	0	-20	15	15	8	4	0	-150
120	180	0	-25	19	15	9	5	0	-175
180	250	0	-30	23	20	10	5	0	-200
250	315	0	-35	26	25	13	7	0	-225
315	400	0	-40	30	30	15	7	0	-300
400	500	0	-45	34	30	18	9	0	-375
500	630	0	-50	38	35	21	11	0	-450
630	800	0	-75	55	40	25	13	0	-525
800	1 000	0	-100	75	45	30	15	0	-600
1 000	1 250	0	-125	95	50	35	18	0	-675

[Note] 1) Applies only to thrust ball bearings with 90° contact angle.

[Remark] Values in Italics are prescribed in JTEKT standards.

(2) Housing washer

Unit :  $\mu\text{m}$

Nominal outside diameter $D$ mm		Single plane mean outside diameter deviation $\Delta_{Dmp}$		Single plane outside diameter variation $V_{Dsp}$	Washer raceway to back face thickness variation $S_e^{1)2)}$
		classes 0, 6, 5			
		over	up to	upper	lower
80	120	0	-22	17	Shall conform to the tolerance $S_i$ on $d$ of the same bearing
120	180	0	-25	19	
180	250	0	-30	23	
250	315	0	-35	26	
315	400	0	-40	30	
400	500	0	-45	34	
500	630	0	-50	38	
630	800	0	-75	55	
800	1 000	0	-100	75	
1 000	1 250	0	-125	95	
1 250	1 600	0	-160	120	

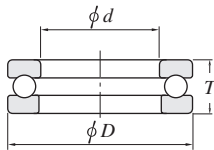

$d$  : shaft washer nominal bore diameter

$D$  : housing washer nominal outside diameter

$T$  : nominal bearing height (single direction)

[Notes] 1) These shall be applied to washer with flat back face only.

2) Applies only to thrust ball bearings with 90° contact angle.

Table 2-8 Accuracies of spherical thrust roller bearings (class 0) = JIS B 1514 =

(1) Shaft washer

Unit :  $\mu\text{m}$

Nominal bore diameter $d$		Single plane mean bore diameter deviation $\Delta_{dmp}$		Single plane bore diameter variation $V_{dsp}$	Refer.		
		classes 0, 6, 5			$S_d$	Deviation of the actual bearing height $\Delta_{Ts}$	
		over	up to	upper		lower	max.
80	120	0	-20	15	25	+200	-200
120	180	0	-25	19	30	+250	-250
180	250	0	-30	23	30	+300	-300
250	315	0	-35	26	35	+350	-350
315	400	0	-40	30	40	+400	-400
400	500	0	-45	34	45	+450	-450
500	630	0	-50	38	60	+500	-500
630	800	0	-75	55	70	+550	-550
800	1 000	0	-100	75	80	+600	-600
1 000	1 250	0	-125	95	100	+650	-650

$S_d$  : Perpendicularity of inner ring face with respect to the bore

[Remark] Values in Italics are prescribed in JTEKT standards.

(2) Housing washer

Unit :  $\mu\text{m}$

Nominal outside diameter $D$ , mm		Single plane mean outside diameter deviation $\Delta_{Dmp}$	
over	up to	upper	lower
120	180	0	-25
180	250	0	-30
250	315	0	-35
315	400	0	-40
400	500	0	-45
500	630	0	-50
630	800	0	-75
800	1 000	0	-100

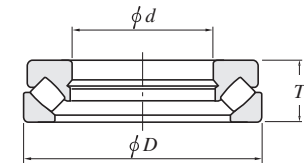

$d$  : shaft washer nominal bore diameter

$D$  : housing washer nominal outside diameter

$T$  : nominal bearing height



2. Bearing tolerances

Table 2-9 Permissible values for chamfer dimensions = JIS B 1514 =

(1) Radial bearing (tapered roller bearings excluded)

Unit : mm

$r_{min}$ or $r_{1min}$	Nominal bore diameter $d$ mm		$r_{max}$ or $r_{1max}$	
	over	up to	Radial direction	Axial direction
0.6	–	40	1	2
	40	–	1.3	2
1	–	50	1.5	3
	50	–	1.9	3
1.1	–	120	2	3.5
	120	–	2.5	4
1.5	–	120	2.3	4
	120	–	3	5
2	–	80	3	4.5
	80	220	3.5	5
	220	–	3.8	6
2.1	–	280	4	6.5
	280	–	4.5	7
2.5	–	100	3.8	6
	100	280	4.5	6
	280	–	5	7
3	–	280	5	8
	280	–	5.5	8
4	–	–	6.5	9
5	–	–	8	10
6	–	–	10	13
7.5	–	–	12.5	17
9.5	–	–	15	19
12	–	–	18	24
15	–	–	21	30
19	–	–	25	38

[Remarks]

- Value of  $r_{max}$  or  $r_{1max}$  in the axial direction of bearings with nominal width lower than 2 mm shall be the same as the value in radial direction.
- There shall be no specification for the accuracy of the shape of the chamfer surface, but its outline in the axial plane shall not be situated outside of the imaginary circle arc with a radius of  $r_{min}$  or  $r_{1min}$  which contacts the inner ring side face and bore, or the outer ring side face and outside surface.

(2) Radial bearings with locating snap ring (snap ring groove side) and cylindrical roller bearings (separate thrust collar and loose rib side)

Unit : mm

$r_{1min}$	Nominal bore dia. or nominal outside dia. $d$ or $D$		$r_{1max}$	
	over	up to	Radial direction	Axial direction
0.6	–	40	1	1.5
	40	–	1.3	1.5
1	–	50	1.5	2.2
	50	–	1.9	2.2
1.1	–	120	2	2.7
	120	–	2.5	2.7
1.5	–	120	2.3	3.5
	120	–	3	3.5
2	–	80	3	4
	80	220	3.5	4
	220	–	3.8	4
2.1	–	280	4	4.5
	280	–	4.5	4.5
2.5	–	100	3.8	5
	100	280	4.5	5
	280	–	5	5
3	–	280	5	5.5
	280	–	5.5	5.5
4	–	–	6.5	6.5
5	–	–	8	8
6	–	–	10	10

[Remark] There shall be no specification for the accuracy of the shape of the chamfer surface, but its outline in the axial plane shall not be situated outside of the imaginary circle arc with a radius of  $r_{1min}$  which contacts the inner ring side face and bore, or the outer ring side face and outside surface.

(3) Cylindrical roller bearings (non-rib side) and angular contact ball bearings (front face side)

Unit : mm

$r_{1min}$	Nominal bore dia. or nominal outside dia. $d$ or $D$		$r_{1max}$	
	over	up to	Radial direction	Axial direction
0.6	–	40	1	2
	40	–	1.3	2
1	–	50	1.5	3
	50	–	1.9	3
1.1	–	120	2	3.5
	120	–	2.5	4
1.5	–	120	2.3	4
	120	–	3	5
2	–	80	3	4.5
	80	220	3.5	5
	220	–	3.8	6

[Remark] There shall be no specification for the accuracy of the shape of the chamfer surface, but its outline in the axial plane shall not be situated outside of the imaginary circle arc with a radius of  $r_{1min}$  which contacts the inner ring side face and bore, or the outer ring side face and outside surface.

(4) Metric series tapered roller bearing

Unit : mm

$r_{min}$ or $r_{1min}$	Nominal bore dia. or nominal outside dia. $d$ or $D$ , mm		$r_{max}$ or $r_{1max}$	
	over	up to	Radial direction	Axial direction
0.6	–	40	1.1	1.7
	40	–	1.3	2
1	–	50	1.6	2.5
	50	–	1.9	3
1.5	–	120	2.3	3
	120	250	2.8	3.5
	250	–	3.5	4
2	–	120	2.8	4
	120	250	3.5	4.5
	250	–	4	5
2.5	–	120	3.5	5
	120	250	4	5.5
	250	–	4.5	6
3	–	120	4	5.5
	120	250	4.5	6.5
	250	400	5	7
4	–	120	5.5	7.5
	120	250	6	8
	250	400	6.5	8.5
5	–	180	6.5	8
	180	–	7.5	9
6	–	180	7.5	10
	180	–	9	11
7.5	–	–	12.5	17
9.5	–	–	15	19

[Note] 1) Inner ring shall be included in division  $d$ , and outer ring, in division  $D$ .

[Remarks]

- There shall be no specification for the accuracy of the shape of the chamfer surface, but its outline in the axial plane shall not be situated outside of the imaginary circle arc with a radius of  $r_{min}$  or  $r_{1min}$  which contacts the inner ring back face and bore, or the outer ring back face and outside surface.
- Values in Italics are provided in JTEKT standards.

(5) Thrust bearing

Unit : mm

$r_{min}$ OR $r_{1min}$	$r_{max}$ OR $r_{1max}$
	Radial and axial direction
0.6	1.5
1	2.2
1.1	2.7
1.5	3.5
2	4
2.1	4.5
3	5.5
4	6.5
5	8
6	10
7.5	12.5
9.5	15
12	18
15	21
19	25

[Remark] There shall be no specification for the accuracy of the shape of the chamfer surface, but its outline in the axial plane shall not be situated outside of the imaginary circle arc with a radius of  $r_{min}$  or  $r_{1min}$  which contacts with the shaft washer back face and bore, or the housing washer back face and outside surface.

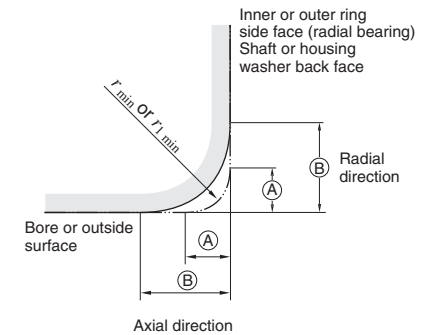

(A) :  $r_{min}$  OR  $r_{1min}$   
(B) :  $r_{max}$  OR  $r_{1max}$

2. Bearing tolerances

Table 2-10 Tolerances for tapered bores of radial bearings (class 0 ... JIS B 1514)

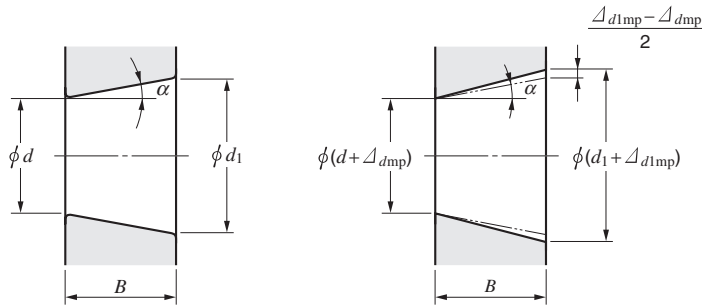

Theoretical tapered bore

Tapered bore with single plane mean bore diameter deviation

(1) Basically tapered bore (taper 1:12) Unit : μm

Nominal bore diameter <i>d</i> , mm	$\Delta_{dmp}$		$\Delta_{d1mp} - \Delta_{dmp}$		$V_{dsp}^{1)}$ max.	
	over	up to	upper	lower		
30	50	+ 39	0	+ 25	0	16
50	80	+ 46	0	+ 30	0	19
80	120	+ 54	0	+ 35	0	22
120	180	+ 63	0	+ 40	0	40
180	250	+ 72	0	+ 46	0	46
250	315	+ 81	0	+ 52	0	52
315	400	+ 89	0	+ 57	0	57
400	500	+ 97	0	+ 63	0	63
500	630	+110	0	+ 70	0	70
630	800	+125	0	+ 80	0	-
800	1 000	+140	0	+ 90	0	-
1 000	1 250	+165	0	+105	0	-
1 250	1 600	+195	0	+125	0	-

(2) Basically tapered bore (taper 1:30) Unit : μm

Nominal bore diameter <i>d</i> , mm	$\Delta_{dmp}$		$\Delta_{d1mp} - \Delta_{dmp}$		$V_{dsp}^{1)}$ max.	
	over	up to	upper	lower		
50	80	+15	0	+30	0	19
80	120	+20	0	+35	0	22
120	180	+25	0	+40	0	40
180	250	+30	0	+46	0	46
250	315	+35	0	+52	0	52
315	400	+40	0	+57	0	57
400	500	+45	0	+63	0	63
500	630	+50	0	+70	0	70

[Note] 1) These shall be applied to all radial planes with tapered bore, not be applied to bearings of diameter series 7, 8.  
 [Remark] 1) Symbols of quantity  $d_1$ : reference diameter at theoretical large end of tapered bore

$$d_1 = d + \frac{1}{12} B \text{ or } d_1 = d + \frac{1}{30} B$$

- $\Delta_{dmp}$ : single plane mean bore diameter deviation at theoretical small end of tapered bore
- $\Delta_{d1mp}$ : single plane mean bore diameter deviation at theoretical large end of tapered bore
- $V_{dsp}$ : single plane bore diameter variation (a tolerance for the diameter variation given by a maximum value applying in any radial plane of the bore)
- $B$ : nominal inner ring width
- $\alpha$ :  $\frac{1}{2}$  of nominal tapered angle of tapered bore
  - (tapered ratio 1/12)  $\alpha = 2^\circ 23' 9.4'' = 2.385 94^\circ = 0.041 643 \text{ rad}$
  - (tapered ratio 1/30)  $\alpha = 0^\circ 57' 17.4'' = 0.954 84^\circ = 0.016 665 \text{ rad}$

3. Bearing fits

3-1 Purpose of fit

The purpose of fit is to securely fix the inner or outer ring to the shaft or housing, to preclude detrimental circumferential sliding on the fitting surface.

Such detrimental sliding (referred to as "creep") will cause abnormal heat generation, wear of the fitting surface, infiltration of abrasion metal particles into the bearing, vibration, and many other harmful effects, which cause a deterioration of bearing functions.

Therefore, it is necessary to fix the bearing ring which is rotating under load to the shaft or housing with interference.

3-2 Tolerance and fit for shaft & housing

For metric series bearings, tolerances for the shaft diameter and housing bore diameter are standardized in JIS B 0401 "limits and fits for engineering" (based on ISO 286 ; shown in Appendixes at the back of this catalog).

Bearing fits on the shaft and housing are determined based on the tolerances specified in the above standard.

Fig. 3-1 shows the relationship between tolerances for shaft and housing bore diameters and fits for bearings of class 0 tolerance.

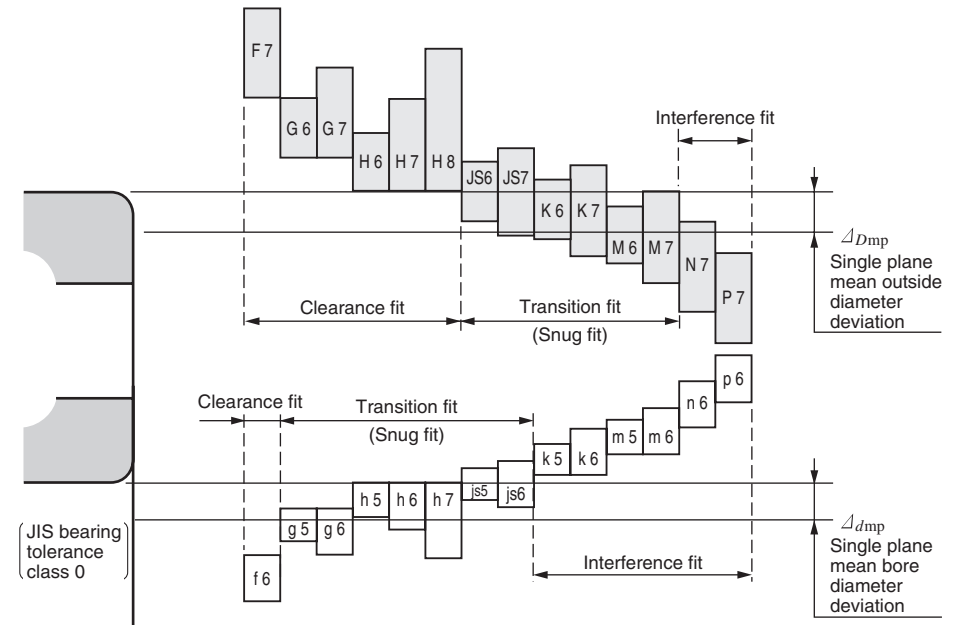

Fig. 3-1 Relationship between tolerances for shaft/housing bore diameters and fits (bearings of class 0 tolerance)

### 3. Bearing fits

#### 3-3 Fit selection

In selecting the proper fit, careful consideration should be given to bearing operating conditions.

Major specific considerations are :

- Load characteristics and magnitude
- Temperature distribution in operating
- Bearing internal clearance
- Surface finish, material and thickness of shaft and housing
- Mounting and dismounting methods
- Necessity to compensate for shaft thermal expansion at the fitting surface
- Bearing type and size





In view of these considerations, the following paragraphs explain the details of the important factors in fit selection.

#### 1) Load characteristics

Load characteristics are classified into three types : rotating inner ring load; rotating outer ring load and indeterminate direction load.

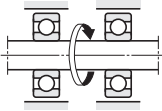
Table 3-1 tabulates the relationship between these characteristics and fit.

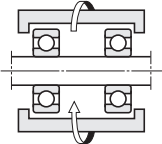
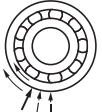
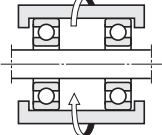
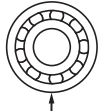
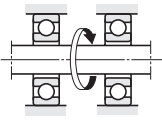
Table 3-1 Load characteristics and fits

Rotation pattern	Direction of load	Loading conditions	Fit		Typical application
			Inner ring & shaft	Outer ring & housing	
 <p>Inner ring : rotating Outer ring : stationary</p>	 <p>Stationary</p>	Rotating inner ring load	Interference fit necessary	Clearance fit acceptable	Spur gear boxes, motors
 <p>Inner ring : stationary Outer ring : rotating</p>	 <p>Rotating with outer ring</p>	Stationary outer ring load	(k, m, n, p, r)	(F, G, H, JS)	Greatly unbalanced wheels
 <p>Inner ring : stationary Outer ring : rotating</p>	 <p>Stationary</p>	Stationary inner ring load	Clearance fit acceptable	Interference fit necessary	Running wheels & pulleys with stationary shaft
 <p>Inner ring : rotating Outer ring : stationary</p>	 <p>Rotating with inner ring</p>	Rotating outer ring load	(f, g, h, js)	(K, M, N, P)	Shaker screens (unbalanced vibration)
Indeterminate	Rotating or stationary	Indeterminate direction load	Interference fit	Interference fit	Cranks

#### 2) Effect of load magnitude

When a radial load is applied, the inner ring will expand slightly. Since this expansion enlarges the circumference of the bore minutely, the initial interference is reduced.

The reduction can be calculated by the following equations :

[In the case of  $F_r \leq 0.25 C_0$ ]

$$\Delta_{dF} = 0.08 \sqrt{\frac{d}{B}} \cdot F_r \times 10^{-3} \dots\dots\dots (3-1)$$

[In the case of  $F_r > 0.25 C_0$ ]

$$\Delta_{dF} = 0.02 \frac{F_r}{B} \times 10^{-3} \dots\dots\dots (3-2)$$

where :

- $\Delta_{dF}$  : reduction of inner ring interference mm
- $d$  : nominal bore diameter of bearing mm
- $B$  : nominal inner ring width mm
- $F_r$  : radial load N
- $C_0$  : basic static load rating N

Consequently, when the radial load, exceeds the  $C_0$  value by more than 25 %, greater interference is needed.

Much greater interference is needed, when impact loads are expected.

#### 3) Effect of fitting surface roughness

The effective interference obtained after fitting differs from calculated interference due to plastic deformation of the ring fitting surface. When the inner ring is fitted, the effective interference, subject to the effect of the fitting surface finish, can be approximated by the following equations :

[In the case of a ground shaft]

$$\Delta_{deff} \doteq \frac{d}{d+2} \Delta_d \dots\dots\dots (3-3)$$

[In the case of a turned shaft]

$$\Delta_{deff} \doteq \frac{d}{d+3} \Delta_d \dots\dots\dots (3-4)$$

where :

- $\Delta_{deff}$  : effective interference mm
- $\Delta_d$  : calculated interference mm
- $d$  : nominal bore diameter of bearing mm

#### 4) Effect of temperature

A bearing generally has an operating temperature, higher than the ambient temperature. When the inner ring operates under load, its temperature generally becomes higher than that of the shaft and the effective interference decreases due to the greater thermal expansion of the inner ring.

If the assumed temperature difference between the bearing inside and surrounding housing is  $\Delta_t$ , the temperature difference at the fitting surfaces of the inner ring and shaft will be approximately  $(0.10 \text{ to } 0.15) \times \Delta_t$ .

The reduction of interference ( $\Delta_{dt}$ ) due to temperature difference is then expressed as follows :

$$\Delta_{dt} = (0.10 \text{ to } 0.15) \Delta_t \cdot \alpha \cdot d \doteq 0.0015 \Delta_t \cdot d \times 10^{-3} \dots\dots\dots (3-5)$$

where :

- $\Delta_{dt}$  : reduction of interference due to temperature difference mm
- $\Delta_t$  : temperature difference between the inside of the bearing and the surrounding housing °C
- $\alpha$  : linear expansion coefficient of bearing steel ( $\doteq 12.5 \times 10^{-6}$ ) 1/°C
- $d$  : nominal bore diameter of bearing mm

Consequently, when a bearing is higher in temperature than the shaft, greater interference is required.

However, a difference in temperature or in the coefficient of expansion may sometimes increase the interference between outer ring and housing. Therefore, when clearance is provided to accommodate shaft thermal expansion, care should be taken.

3. Bearing fits

5) Maximum stress due to fit

When a bearing is fitted with interference, the bearing ring will expand or contract, generating internal stress.

Should this stress be excessive, the bearing ring may fracture.

The maximum bearing fitting-generated stress is determined by the equation in Table 3-2.

In general, to avoid fracture, it is best to adjust the maximum interference to less than 1/1 000 of the shaft diameter, or the maximum stress ( $\sigma$ ), determined by the equation in Table 3-2, should be less than 120 MPa.

Table 3-2 Maximum fitting-generated stress in bearings

Shaft & inner ring	Housing bore & outer ring
(In the case of hollow shaft)	(In the case of $D_h \neq \infty$ )
$\sigma = \frac{E}{2} \cdot \frac{\Delta_{def}}{d} \cdot \frac{\left(1 - \frac{d_0^2}{d^2}\right) \left(1 + \frac{d^2}{D_i^2}\right)}{\left(1 - \frac{d_0^2}{D_i^2}\right)}$	$\sigma = E \cdot \frac{\Delta_{Def}}{D} \cdot \frac{\left(1 - \frac{D^2}{D_h^2}\right)}{\left(1 - \frac{D_e^2}{D_h^2}\right)}$
(In the case of solid shaft)	(In the case of $D_h = \infty$ )
$\sigma = \frac{E}{2} \cdot \frac{\Delta_{def}}{d} \cdot \left(1 + \frac{d^2}{D_i^2}\right)$	$\sigma = E \cdot \frac{\Delta_{Def}}{D}$

where :

- $\sigma$  : maximum stress MPa
- $d$  : nominal bore diameter (shaft diameter) mm
- $D_i$  : raceway contact diameter of inner ring mm
  - ball bearing .....  $D_i \doteq 0.2 (D + 4 d)$
  - roller bearing ...  $D_i \doteq 0.25 (D + 3 d)$
- $\Delta_{def}$  : effective interference of inner ring mm
- $d_0$  : bore diameter of hollow shaft mm
- $D_e$  : raceway contact diameter of outer ring mm
  - ball bearing .....  $D_e \doteq 0.2 (4D + d)$
  - roller bearing ...  $D_e \doteq 0.25 (3D + d)$
- $D$  : nominal outside diameter (bore diameter of housing) mm
- $\Delta_{Def}$  : effective interference of outer ring mm
- $D_h$  : outside diameter of housing mm
- $E$  : young's modulus  $2.08 \times 10^5$  MPa

[Remark] The above equations are applicable when the shaft and housing are steel. When other materials are used, JTEKT should be consulted.

6) Other considerations

When a high degree of accuracy is required, the tolerance of the shaft and housing must be improved. Since the housing is generally less easy to machine precisely than the shaft, it is advisable to use a clearance fit on the outer ring.

With hollow shafts or thin section housings, greater than normal interference is needed.

With split housings, on the other hand, smaller interference with outer ring is needed.

When the housing is made of aluminum or other light metal alloy, relatively greater than normal interference is needed.

In such a case, consult with JTEKT.

Fits recommended for radial bearings and thrust bearings are shown in Tables 3-3 through 3-6. Fits for rolling mill roll neck bearings are described in section 3-4.

Table 3-3 (1) Recommended shaft fits for radial bearings (classes 0, 6X, 6)

Conditions <sup>1)</sup>	Ball bearing		Cylindrical roller bearing Tapered roller bearing		Spherical roller bearing		Class of shaft tolerance range	Remarks	Applications (for reference)
	Shaft diameter (mm)								
	over	up to	over	up to	over	up to			
Cylindrical bore bearing (classes 0, 6X, 6)									
Rotating inner ring load or indeterminate direction load	Light load or fluctuating load $\left[\frac{P_r}{C_r} \leq 0.06\right]$	18 100	– 40	– –	– –	js 6	For applications requiring high accuracy, js 5, k 5 and m 5 should be used in place of js 6, k 6 and m 6.	Electric appliances, machine tools, pumps, blowers, carriers etc.	
		100 200	40 140	– –	– –	k 6			
	Normal load $\left[0.06 < \frac{P_r}{C_r} \leq 0.12\right]$	– –	140 200	– 40	– 40	– –	m 6	For single-row tapered roller bearings and angular contact ball bearings, k 5 and m 5 may be replaced by k 6 and m 6, because internal clearance reduction due to fit need not be considered.	Electric motors, turbines, internal combustion engines, wood-working machines etc.
		18 100	100 140	40 100	40 65	k 5			
100 140		140 200	100 140	65 100	m 5				
140 200		200 280	140 200	100 140	m 6				
Heavy load or impact load $\left[\frac{P_r}{C_r} > 0.12\right]$	– –	– –	200 400	140 280	p 6	Bearings with larger internal clearance than standard are required.	Railway rolling stock axle journals, traction motors		
	– –	– –	– –	280 500	r 6				
	– –	– –	– –	500 –	r 7				
	– –	– –	50 140	100 140	n 6				
Stationary inner ring load	Inner ring needs to move smoothly on shaft.	All shaft diameters				g 6	For applications requiring high accuracy, g 5 should be used. For large size bearing, f 6 may be used for easier movement.	Stationary shaft wheels	
		Inner ring does not need to move smoothly on shaft.	All shaft diameters				h 6	For applications requiring high accuracy, h 5 should be used.	Tension pulleys, rope sheaves etc.
Central axial load only	All shaft diameters				js 6	–	–		
Tapered bore bearing (class 0) (with adapter or withdrawal sleeve)									
All loads	All shaft diameters				h 9 / IT 5 <sup>2)</sup>	For transmission shafts, h 10 / IT 7 <sup>2)</sup> may be applied.	–		

[Notes] 1) Light, normal, and heavy loads refer to those with dynamic equivalent radial loads ( $P_r$ ) of 6% or lower, over 6% up to 12% inclusive, and over 12% respectively in relation to the basic dynamic radial load rating ( $C_r$ ) of the bearing concerned.

2) IT 5 and IT 7 mean that shaft roundness tolerance, cylindricity tolerance, and other errors in terms of shape should be within the tolerance range of IT 5 and IT 7, respectively. For numerical values for standard tolerance grades IT 5 and IT 7, refer to supplementary table at end of this catalog.

[Remark] This table is applicable to solid steel shafts.

3. Bearing fits

Table 3-3 (2) Recommended housing fits for radial bearings (classes 0, 6X, 6)

Conditions			Class of housing bore tolerance range	Remarks	Applications (for reference)	
Housing	Load type etc. <sup>1)</sup>	Outer ring axial displacement <sup>2)</sup>				
One-piece or split type	Stationary outer ring load	All load types	H 7	G 7 may be applied when a large size bearing is used, or if the temperature difference is large between the outer ring and housing.	Ordinary bearing devices, railway rolling stock axle boxes, power transmission equipment etc.	
		Light or normal load	Easily displaceable	H 8	–	
		High temperature at shaft and inner ring		G 7	F 7 may be applied when a large size bearing is used, or if the temperature difference is large between the outer ring and housing.	Drying cylinders etc.
One-piece type	Indeterminate direction load	Light or normal load, requiring high running accuracy	Not displaceable in principle	K 6	Mainly applied to roller bearings.	
			Displaceable	JS 6	Mainly applied to ball bearings.	
		Requiring low-noise rotation	Easily displaceable	H 6	–	
	Rotating outer ring load	Light or normal load	Normally displaceable	JS 7	For applications requiring high accuracy, JS 6 and K 6 should be used in place of JS 7 and K 7.	Electric motors, pumps, crankshaft main bearings etc.
		Normal or heavy load	Not displaceable in principle	K 7	–	Traction motors etc.
		High impact load	Not displaceable	M 7	–	
Rotating outer ring load	Light or fluctuating load	Not displaceable	M 7	–	Conveyor rollers, ropeways, tension pulleys etc.	
	Normal or heavy load		N 7	Mainly applied to ball bearings.	Wheel hubs with ball bearings etc.	
	Thin section housing, heavy or high impact load		P 7	Mainly applied to roller bearings.	Wheel hubs with roller bearings, bearings for large end of connecting rods etc.	

[Notes] 1) Loads are classified as stated in Note 1) to Table 3-3 (1).

2) Indicating distinction between applications of non-separable bearings permitting and not permitting axial displacement of the outer rings.

[Remarks] 1. This table is applicable to cast iron or steel housings.

2. If only central axial load is applied to the bearing, select such tolerance range class as to provide clearance in the radial direction for outer ring.

Table 3-4 Recommended shaft and housing fits for inch series tapered roller bearings (classes 4, 2)

(1) Fits for shaft

Load type		Nominal bore diameter $d$ mm (1/25.4)		Deviation of a single bore diameter $\Delta d_s, \mu\text{m}$		Dimensional tolerance of shaft diameter $\mu\text{m}$		Remarks		
		over	up to	upper	lower	upper	lower			
Rotating inner ring load	Normal load	76.2 ( 3.0)	304.8 (12.0)	+25	0	+ 64	+ 38	Generally, bearing internal clearance should be larger than standard.		
		304.8 (12.0)	609.6 (24.0)	+51	0	+127	+ 76			
Rotating outer ring load	Normal load without impact	76.2 ( 3.0)	304.8 (12.0)	+25	0	+ 25	0		Should be such that average interference stands at $0.0005 \times d$ (mm)	
		304.8 (12.0)	609.6 (24.0)	+51	0	+ 51	0			
Rotating inner ring load	Heavy load Impact load High speed rotation	76.2 ( 3.0)	304.8 (12.0)	+25	0	+ 64	+ 38			Generally, bearing internal clearance should be larger than standard.
		304.8 (12.0)	609.6 (24.0)	+51	0	+127	+ 76			
Rotating outer ring load	Normal load without impact	76.2 ( 3.0)	304.8 (12.0)	+25	0	0	- 25	Inner ring is displaceable in axial direction.		
		304.8 (12.0)	609.6 (24.0)	+51	0	0	- 51			
Rotating inner ring load	Heavy load Impact load High speed rotation	76.2 ( 3.0)	304.8 (12.0)	+25	0	+ 64	+ 38		Generally, bearing internal clearance should be larger than standard.	
		304.8 (12.0)	609.6 (24.0)	+51	0	+127	+ 76			
Rotating outer ring load	Normal load without impact	76.2 ( 3.0)	304.8 (12.0)	+25	0	0	- 25			Inner ring is displaceable in axial direction.
		304.8 (12.0)	609.6 (24.0)	+51	0	0	- 51			
Rotating inner ring load	Heavy load Impact load High speed rotation	76.2 ( 3.0)	304.8 (12.0)	+25	0	+ 64	+ 38	Generally, bearing internal clearance should be larger than standard.		
		304.8 (12.0)	609.6 (24.0)	+51	0	+127	+ 76			

(2) Fits for housing

Load type		Nominal outside diameter $D$ mm (1/25.4)		Deviation of a single outside diameter $\Delta D_s, \mu\text{m}$		Dimensional tolerance of housing bore diameter $\mu\text{m}$		Remarks
		over	up to	upper	lower	upper	lower	
Rotating inner ring load	Used for free or fixed side.	76.2 ( 3.0)	127.0 ( 5.0)	+ 25	0	+ 76	+ 51	Outer ring is easily displaceable in axial direction.
		127.0 ( 5.0)	304.8 (12.0)	+ 25	0	+ 76	+ 51	
		304.8 (12.0)	609.6 (24.0)	+ 51	0	+152	+105	
Rotating inner ring load	Position of outer ring is adjustable (in axial direction).	76.2 ( 3.0)	127.0 ( 5.0)	+ 25	0	+ 25	0	Outer ring is displaceable in axial direction.
		127.0 ( 5.0)	304.8 (12.0)	+ 25	0	+ 51	0	
		304.8 (12.0)	609.6 (24.0)	+ 51	0	+ 76	+ 25	
Rotating outer ring load	Position of outer ring is not adjustable (in axial direction).	76.2 ( 3.0)	127.0 ( 5.0)	+ 25	0	- 25	- 51	Outer ring is fixed in axial direction.
		127.0 ( 5.0)	304.8 (12.0)	+ 25	0	- 25	- 51	
		304.8 (12.0)	609.6 (24.0)	+ 51	0	- 25	- 76	
Rotating outer ring load	Position of outer ring is not adjustable (in axial direction).	76.2 ( 3.0)	127.0 ( 5.0)	+ 25	0	- 25	- 102	Outer ring is fixed in axial direction.
		127.0 ( 5.0)	304.8 (12.0)	+ 25	0	- 25	- 51	
		304.8 (12.0)	609.6 (24.0)	+ 51	0	- 25	- 76	

3. Bearing fits

Table 3-5 Recommended shaft and housing fits for metric J series tapered roller bearings (classes PK, PN)

(1) Fits for shaft

Load type		Nominal bore diameter $d$ mm		Class of shaft tolerance range	Remarks
		over	up to		
Rotating inner ring load	Normal load	10	120	m 6	Generally, bearing internal clearance should be larger than standard.
		120	500	n 6	
	Heavy load Impact load High speed rotation	10	120	n 6	
		120	180	p 6	
		180	250	r 6	
		250	500	r 7	
Rotating outer ring load	Normal load without impact	80	315	h 6 or g 6	Generally, bearing internal clearance should be larger than standard.
		10	120	n 6	
	Heavy load Impact load High speed rotation	120	180	p 6	
		180	250	r 6	
		250	500	r 7	

(2) Fits for housing

Load type		Nominal outside diameter $D$ mm		Class of housing bore diameter tolerance range	Remarks
		over	up to		
Rotating inner ring load	Used for free or fixed side	18	315	G 7	Outer ring is easily displaceable in axial direction.
		315	400	F 6	
	Position of outer ring is adjustable (in axial direction)	18	400	J 7	
	Position of outer ring is not adjustable (in axial direction)	18	400	P 7	Outer ring is fixed in axial direction.
Rotating outer ring load	Position of outer ring is not adjustable (in axial direction)	18	120	R 7	Outer ring is fixed in axial direction.
		120	180		
		180	400		

Table 3-6 Recommended shaft and housing fits for thrust bearings (classes 0, 6)

(1) Fits for shaft

Load type	Shaft diameter, mm		Class of shaft tolerance range	Remarks
	over	up to		
Central axial load (generally for thrust bearings)	All shaft diameters		js 6	h 6 may also be used.
Combined load (spherical thrust roller bearing)	Stationary shaft washer load	All shaft diameters	js 6	–
	Rotating shaft washer load or indeterminate direction load	– 200 200 400 400 –	k 6 m 6 n 6	js 6, k 6 and m 6 may be used in place of k 6, m 6 and n 6, respectively.

(2) Fits for housing

Load type	Class of housing bore diameter tolerance range	Remarks
Central axial load (generally for thrust bearings)	–	Select such tolerance range class as provides clearance in the radial direction for housing washer.
	H 8	In case of thrust ball bearings requiring high accuracy.
Combined load (spherical thrust roller bearing)	Stationary housing washer load	H 7
	Indeterminate direction load or rotating housing washer load	K 7 M 7

[Remark] This table is applicable to cast iron or steel housings.

3. Bearing fits

3-4 Recommended fits for rolling mill roll neck bearing

A rolling mill roll neck bearing is subject to inner ring rotating load. Its inner ring always receives a load on its entire circumference, and a load is applied to the outer ring at only one location.

Thus, interference fit is required for the inner ring to prevent any creep, and clearance fit should be used for the outer ring, in principle. For easy attachment, clearance fit has been used for roll neck bearings (because recombination and replacement must be frequently done for roll grinding).

However, with more increase in rolling speed and rolling load, interference fit has been more

commonly used to prevent danger of creep to be generated when clearance fit is used and improve in accuracy of products.

Clearance fit is used for the inner rings of deep groove ball bearings and angular ball bearings used as bearings receiving axial load. Between the outer ring and the chock, adequate clearance should be provided in order to prevent any radial load applied to the outer ring.

Tables 3-7 through 3-10 show the recommended fits for roll neck bearings.

When machining a roll neck or chock, its roundness must not exceed 50 % of the allowable tolerances shown in Tables 3-7 through 3-10. If its roundness is poor, fretting corrosion may frequently occur.

Table 3-8 Recommended fits for roll neck inch series four-row tapered roller bearing

Double cone and roll neck (shaft)						Cup and chock (housing)					
Nominal bore diameter <i>d</i> mm (1/25.4)		Single bore diameter deviation $\Delta_{ds}$ $\mu\text{m}$		Roll neck diameter deviation $\mu\text{m}$		Nominal outside diameter <i>D</i> mm (1/25.4)		Single outside diameter deviation $\Delta_{Ds}$ $\mu\text{m}$		Chock bore diameter deviation $\mu\text{m}$	
over	up to	upper	lower	upper	lower	over	up to	upper	lower	upper	lower
76.2 ( 3.0)	101.6 ( 4.0)	+ 25	0	- 75	-100	-	304.8 (12.0)	+ 25	0	+ 75	+ 50
101.6 ( 4.0)	127.0 ( 5.0)	+ 25	0	-100	-125	304.8 (12.0)	609.6 (24.0)	+ 51	0	+150	+100
127.0 ( 5.0)	152.4 ( 6.0)	+ 25	0	-125	-150	609.6 (24.0)	914.4 (36.0)	+ 76	0	+225	+150
152.4 ( 6.0)	203.2 ( 8.0)	+ 25	0	-150	-175	914.4 (36.0)	1 219.2 (48.0)	+102	0	+300	+200
203.2 ( 8.0)	304.8 (12.0)	+ 25	0	-175	-200	1 219.2 (48.0)	1 524.0 (60.0)	+127	0	+375	+250
304.8 (12.0)	609.6 (24.0)	+ 51	0	-200	-250	1 524.0 (60.0)		+127	0	+450	+300
609.6 (24.0)	914.4 (36.0)	+ 76	0	-250	-325						
914.4 (36.0)	1 219.2 (48.0)	+102	0	-300	-400						
1 219.2 (48.0)		+127	0	-375	-475						

Table 3-7 Recommended fits for roll neck metric series four-row tapered roller bearing

Double cone and roll neck (shaft)				Cup and chock (housing)							
Nominal bore diameter <i>d</i> , mm		Single plane mean bore diameter deviation $\Delta_{dmp}$ $\mu\text{m}$		Roll neck diameter deviation $\mu\text{m}$		Nominal outside diameter <i>D</i> , mm		Single plane mean outside diameter deviation $\Delta_{Dmp}$ $\mu\text{m}$		Chock bore diameter deviation $\mu\text{m}$	
over	up to	upper	lower	upper	lower	over	up to	upper	lower	upper	lower
80	120	0	- 20	-120	-150	120	150	0	- 20	+ 57	+ 25
120	180	0	- 25	-150	-175	150	180	0	- 25	+100	+ 50
180	250	0	- 30	-175	-200	180	250	0	- 30	+120	+ 50
250	315	0	- 35	-210	-250	250	315	0	- 35	+115	+ 50
315	400	0	- 40	-240	-300	315	400	0	- 40	+110	+ 50
400	500	0	- 45	-245	-300	400	500	0	- 45	+105	+ 50
500	630	0	- 50	-250	-300	500	630	0	- 50	+100	+ 50
630	800	0	- 75	-325	-400	630	800	0	- 75	+150	+ 75
800	1 000	0	-100	-350	-425	800	1 000	0	-100	+150	+ 75
1 000	1 250	0	-125	-425	-500	1 000	1 250	0	-125	+175	+100
1 250	1 600	0	-160	-510	-600	1 250	1 600	0	-160	+215	+125
						1 600	2 000	0	-200	+250	+150

3. Bearing fits

Table 3-9 Recommended fits for roll neck four-row cylindrical roller bearing (inner ring interference fit)

Inner ring and roll neck (shaft)						Outer ring and chock (housing)					
Nominal bore diameter <i>d</i> , mm		Single plane mean bore diameter deviation $\Delta_{dmp}$ $\mu\text{m}$		Roll neck diameter deviation $\mu\text{m}$		Nominal outside diameter <i>D</i> , mm		Single plane mean outside diameter deviation $\Delta_{Dmp}$ $\mu\text{m}$		Chock bore diameter deviation $\mu\text{m}$	
over	up to	upper	lower	upper	lower	over	up to	upper	lower	upper	lower
80	120	0	-20	+59	+37 (p6)	120	150	0	-18	+40	0 (H7)
120	180	0	-25	+68	+43 (p6)	150	180	0	-25	+40	0 (H7)
180	250	0	-30	+79	+50 (p6)	180	250	0	-30	+46	0 (H7)
250	280	0	-35	+126	+94 (r6)	250	315	0	-35	+52	0 (H7)
280	315	0	-35	+130	+98 (r6)						
315	355	0	-40	+144	+108 (r6)						
355	400	0	-40	+150	+114 (r6)	315	400	0	-40	+75	+18 (G7)
400	450	0	-45	+166	+126 (r6)	400	500	0	-45	+83	+20 (G7)
450	500	0	-45	+172	+132 (r6)						
500	560	0	-50	+194	+150 (r6)	500	630	0	-50	+92	+22 (G7)
560	630	0	-50	+354	+310 (s6)						
630	710	0	-75	+390	+340 (s6)	630	800	0	-75	+160	+80 (F7)
710	800	0	-75	+430	+380 (s6)						
800	900	0	-100	+486	+430 (s6)	800	1 000	0	-100	+176	+86 (F7)
900	1 000	0	-100	+526	+470 (s6)						
1 000	1 120	0	-125	+588	+520 (s6)	1 000	1 250	0	-125	+203	+98 (F7)
1 120	1 250	0	-125	+646	+580 (s6)						
						1 250	1 400	0	-160	+235	+110 (F7)
						1 400	1 600	0	-160	+345	+220 (E7)

[Note] The table above shows general values. JTEKT determines recommended fit on a case by case basis according to bearing materials and operating conditions to prevent the inner ring from creeping. Consult with JTEKT when referring to this table.

Table 3-10 Recommended fits of bearing types for support of axial loading

Bearing type	Inner ring and roll neck (shaft)	Outer ring and chock (housing)	
	Shaft tolerance range class	Mounted to chock	Mounted to sleeve
		Chock bore tolerance range class	Sleeve bore tolerance range class
Deep groove ball bearing	e6 or f6	Nominal chock bore (mm) = Outer ring outer dia. + [0.5 to 1.0] H8	G7
Angular ball bearing			
Double row tapered roller bearing (bearings for support of axial loading) ... TDIS type		G7	
Thrust tapered roller bearing			
Spherical thrust roller bearing			

[Remark] When installing a sleeve, clearance of 0.5 mm or more should be provided between the outer diameter of the sleeve and the bore of the chock.

4. Internal clearance

Bearing internal clearance is defined as the total distance either inner or outer ring can be moved when the other ring is fixed.

If movement is in the radial direction, it is called **radial internal clearance**; if in the axial direction, **axial internal clearance**. (Fig. 4-1)

Bearing performance depends greatly upon internal clearance during operation (also referred to as operating clearance); inappropriate clearance results in short rolling fatigue life and generation of heat, noise or vibration.

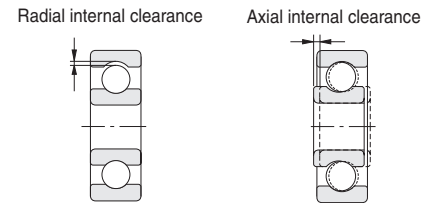

Fig. 4-1 Bearing internal clearance

[Refer.] Relation to radial internal clearance and axial internal clearance

(1) Deep groove ball bearing

$$\Delta_a = \sqrt{\Delta_r (4m_o - \Delta_r)} \dots\dots\dots (4-1)$$

(2) Double-row angular contact ball bearing

$$\Delta_a = 2\sqrt{m_o^2 - (m_o \cos \alpha - \frac{\Delta_r}{2})^2} - 2m_o \sin \alpha \dots\dots\dots (4-2)$$

(3) Matched pair angular contact ball bearing

$$\Delta_a = 2m_o \sin \alpha - 2\sqrt{m_o^2 - (m_o \cos \alpha + \frac{\Delta_r}{2})^2} \dots\dots\dots (4-3)$$

(4) Double/four-row and matched pair tapered roller bearing

$$\Delta_a = \Delta_r \cot \alpha \approx \frac{1.5}{e} \Delta_r \dots\dots\dots (4-4)$$

where :

- $\Delta_a$  : Axial internal clearance mm
- $\Delta_r$  : Radial internal clearance mm
- $\alpha$  : Nominal contact angle deg.
- $e$  : Limited value of  $F_a/F_r$  (shown in the bearing specification table)
- $m_o : r_e + r_i - D_w$  mm
- $r_e$  : Outer ring raceway groove radius mm
- $r_i$  : Inner ring raceway groove radius mm
- $D_w$  : Ball diameter mm

The term **residual clearance** is defined as the original clearance decreased owing to expansion or contraction of a raceway due to fitting, when the bearing is mounted in the shaft and housing.

The term **effective clearance** is defined as the residual clearance decreased owing to dimensional change arising from temperature differentials within the bearing.

The term **operating clearance** is defined as the internal clearance present while a bearing mounted in a machine is rotating under a certain load, or, the effective clearance increased due to elastic deformation arising from bearing loads.

Operating clearance gives great influences on the performance and service life of bearings. Thus, it is recommended to select the operating clearance of a ball bearing so that the operating clearance is slightly positive, while the lower limited value of the operating clearance range of a roller bearing is slightly positive.

It is important to take specific operating conditions into consideration and select a clearance suitable for the conditions.

For example, when high rigidity is required, or when the noise must be minimized, the operating clearance must be reduced. On the other hand, when high operating temperature is expected, the operating clearance must be increased.

Table 4-1 shows how to determine the operating clearance in the case of shaft and housing made of steel. The standard values of bearing internal clearance before mounting are shown in Tables 4-2 through 4-6.



4. Internal clearance

Table 4-1 How to determine operating clearance

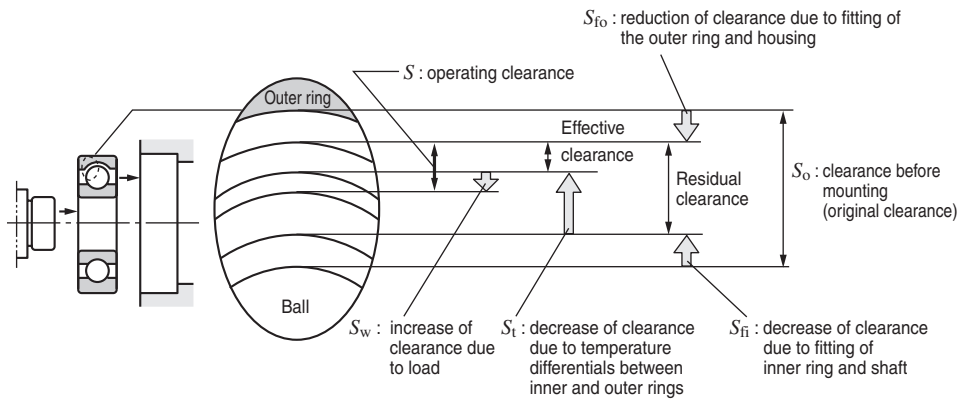

<b>Operating clearance</b> (S)	$S = S_0 - (S_f + S_{11} + S_{12}) + S_w^*$ <p>* <math>S_w</math> (increase of clearance due to load) is generally small, and thus may be ignored, although there is an equation for determining the value.</p>	
<b>Decrease of clearance due to fitting</b> (S <sub>f</sub> )	(In the case of hollow shaft) $S_{fi} = \Delta_{deff} \frac{d}{D_i} \cdot \frac{\left(1 - \frac{d_0^2}{d^2}\right)}{\left(1 - \frac{d_0^2}{D_i^2}\right)}$ (In the case of solid shaft) $S_{fi} = \Delta_{deff} \frac{d}{D_i}$	(In the case of $D_h \neq \infty$ ) $S_{fi0} = \Delta_{Deff} \frac{D_e}{D} \cdot \frac{\left(1 - \frac{D^2}{D_h^2}\right)}{\left(1 - \frac{D_e^2}{D_h^2}\right)}$ (In the case of $D_h = \infty$ ) $S_{fi0} = \Delta_{Deff} \frac{D_e}{D}$
<b>Decrease of clearance due to temperature differentials between inner and outer rings</b> (S <sub>11</sub> )	The amount of decrease varies depending on the state of housing; however, generally the amount can be approximated by the following equation on the assumption that the outer ring will not expand: $S_{11} = \alpha (D_i \cdot t_i - D_e \cdot t_e)$	where : $D_e = D_i + 2D_w$ Consequently, $S_{11} + S_{12}$ will be determined by the following equation : $S_{11} + S_{12} = \alpha \cdot D_i \cdot t_1 + 2\alpha \cdot D_w \cdot t_2$ <p>Temperature differential between the inner and outer rings, <math>t_1</math>, can be expressed as follows :  <math display="block">t_1 = t_i - t_e</math>                 Temperature differential between the rolling element and outer ring, <math>t_2</math>, can be expressed as follows :  <math display="block">t_2 = t_w - t_e</math></p>
<b>Decrease of clearance due to temperature rise of rolling element</b> (S <sub>12</sub> )	$S_{12} = 2\alpha \cdot D_w \cdot t_w$	

In Table 4-1,

- S : operating clearance mm
- S<sub>0</sub> : clearance before mounting mm
- S<sub>f</sub> : decrease of clearance due to fitting mm
- S<sub>fi</sub> : expansion of inner ring raceway contact diameter mm
- S<sub>fi0</sub> : contraction of outer ring raceway contact diameter mm
- S<sub>11</sub> : decrease of clearance due to temperature differentials between inner and outer rings mm
- S<sub>12</sub> : decrease of clearance due to temperature rise of the rolling elements mm
- S<sub>w</sub> : increase of clearance due to load mm
- Δ<sub>deff</sub> : effective interference of inner ring (shaft diameter) mm
- d<sub>0</sub> : bore diameter of hollow shaft mm
- D<sub>i</sub> : inner ring raceway contact diameter mm
  - (ball bearing .....  $D_i \cong 0.2 (D + 4 d)$ )
  - roller bearing ...  $D_i \cong 0.25 (D + 3 d)$ )
- Δ<sub>Deff</sub> : effective interference of outer ring mm
- D<sub>h</sub> : outside diameter of housing mm
- D<sub>e</sub> : outer ring raceway contact diameter mm
  - (ball bearing .....  $D_e \cong 0.2 (4D + d)$ )
  - roller bearing ...  $D_e \cong 0.25 (3D + d)$ )
- D : nominal outside diameter mm
- α : linear expansion coefficient of bearing steel ( $12.5 \times 10^{-6}$ ) 1/°C
- D<sub>w</sub> : average diameter of rolling elements mm
  - (ball bearing .....  $D_w \cong 0.3 (D - d)$ )
  - roller bearing ...  $D_w \cong 0.25 (D - d)$ )
- t<sub>i</sub> : temperature rise of the inner ring °C
- t<sub>e</sub> : temperature rise of the outer ring °C
- t<sub>w</sub> : temperature rise of rolling elements °C

■Bearings are sometimes used with a non-steel shaft or housing. In the automotive industry, a statistical method is often incorporated for selection of clearance. In these cases, or when other special operating conditions are involved, JTEKT should be consulted.

4. Internal clearance

Table 4-2 Radial internal clearance of deep groove ball bearings (cylindrical bore)

Unit : μm

Nominal bore diameter <i>d</i> , mm		Clearance									
		C 2		C N		C 3		C 4		C 5	
over	up to	min.	max.	min.	max.	min.	max.	min.	max.	min.	max.
80	100	1	18	12	36	30	58	53	84	75	120
100	120	2	20	15	41	36	66	61	97	90	140
120	140	2	23	18	48	41	81	71	114	105	160
140	160	2	23	18	53	46	91	81	130	120	180
160	180	2	25	20	61	53	102	91	147	135	200
180	200	2	30	25	71	63	117	107	163	150	230
200	225	2	35	25	85	75	140	125	195	175	265
225	250	2	40	30	95	85	160	145	225	205	300
250	280	2	45	35	105	90	170	155	245	225	340
280	315	2	55	40	115	100	190	175	270	245	370
315	355	3	60	45	125	110	210	195	300	275	410
355	400	3	70	55	145	130	240	225	340	315	460
400	450	3	80	60	170	150	270	250	380	350	510
450	500	3	90	70	190	170	300	280	420	390	570
500	560	10	100	80	210	190	330	310	470	440	630
560	630	10	110	90	230	210	360	340	520	490	690
630	710	20	130	110	260	240	400	380	570	540	760
710	800	20	140	120	290	270	450	430	630	600	840
800	900	20	160	140	320	300	500	480	700	670	940
900	1 000	20	170	150	350	330	550	530	770	740	1 040
1 000	1 120	20	180	160	380	360	600	580	850	820	1 150
1 120	1 250	20	190	170	410	390	650	630	920	890	1 260
1 250	1 400	–	–	<i>180</i>	<i>440</i>	<i>420</i>	<i>700</i>	<i>680</i>	<i>1 000</i>	–	–

[Remark] Values in Italics are prescribed in JTEKT standards.

Table 4-3 (1) Axial internal clearance of matched pair angular contact ball bearings (measurement clearance)<sup>1)</sup>

Unit : μm

Nominal bore diameter <i>d</i> , mm		Contact angle : 15°				Contact angle : 30°							
		C 2		C N		C 2		C N		C 3		C 4	
over	up to	min.	max.	min.	max.	min.	max.	min.	max.	min.	max.	min.	max.
80	100	35	60	85	110	10	30	50	75	80	105	130	155
100	120	40	65	100	125	12	37	65	90	100	125	150	175
120	140	45	75	110	140	15	40	75	105	120	150	180	210
140	160	45	75	125	155	15	40	80	110	130	160	210	240
160	180	50	80	140	170	15	45	95	125	140	170	235	265
180	200	50	80	160	190	20	50	110	140	170	200	275	305

[Note] 1) Including increase of clearance caused by measurement load.

Table 4-3 (2) Axial internal clearance of matched pair angular contact ball bearings (measurement clearance)<sup>1)</sup>

Unit : μm

Nominal bore diameter <i>d</i> , mm		Contact angle : 40°							
		C 2		C N		C 3		C 4	
over	up to	min.	max.	min.	max.	min.	max.	min.	max.
80	100	6	20	20	45	55	80	85	110
100	120	6	25	25	50	60	85	100	125
120	140	7	30	30	60	75	105	125	155
140	160	7	30	35	65	85	115	140	170
160	180	7	31	45	75	100	130	155	185
180	200	7	37	60	90	110	140	170	200

[Note] 1) Including increase of clearance caused by measurement load.

Table 4-4 Radial internal clearance of cylindrical roller bearings

(1) Cylindrical bore bearings

Unit : μm

Nominal bore diameter <i>d</i> , mm		Clearance									
		C 2		C N		C 3		C 4		C 5	
over	up to	min.	max.	min.	max.	min.	max.	min.	max.	min.	max.
40	50	5	35	30	60	50	80	70	100	95	125
50	65	10	40	40	70	60	90	80	110	110	140
65	80	10	45	40	75	65	100	90	125	130	165
80	100	15	50	50	85	75	110	105	140	155	190
100	120	15	55	50	90	85	125	125	165	180	220
120	140	15	60	60	105	100	145	145	190	200	245
140	160	20	70	70	120	115	165	165	215	225	275
160	180	25	75	75	125	120	170	170	220	250	300
180	200	35	90	90	145	140	195	195	250	275	330
200	225	45	105	105	165	160	220	220	280	305	365
225	250	45	110	110	175	170	235	235	300	330	395
250	280	55	125	125	195	190	260	260	330	370	440
280	315	55	130	130	205	200	275	275	350	410	485
315	355	65	145	145	225	225	305	305	385	455	535
355	400	100	190	190	280	280	370	370	460	510	600
400	450	110	210	210	310	310	410	410	510	565	665
450	500	110	220	220	330	330	440	440	550	625	735
500	560	110	225	220	330	335	470	440	575	–	–
560	630	110	245	220	360	375	520	490	635	–	–
630	710	115	275	245	405	420	580	550	710	–	–
710	800	130	305	275	450	470	675	615	790	–	–
800	900	140	340	300	500	520	720	680	880	–	–
900	1 000	160	380	340	560	580	800	760	980	–	–

4. Internal clearance

Table 4-4 Radial internal clearance of cylindrical roller bearings

(2) Tapered bore bearings

Unit : μm

Nominal bore diameter <i>d</i> , mm		Non-interchangeable clearance													
		C 9 NA <sup>1)</sup>		C 1 NA		C 2 NA		C N NA		C 3 NA		C 4 NA		C 5 NA	
over	up to	min.	max.	min.	max.	min.	max.	min.	max.	min.	max.	min.	max.	min.	max.
80	100	10	25	25	45	45	70	80	105	105	125	125	150	180	205
100	120	10	25	25	50	50	80	95	120	120	145	145	170	205	230
120	140	15	30	30	60	60	90	105	135	135	160	160	190	230	260
140	160	15	35	35	65	65	100	115	150	150	180	180	215	260	295
160	180	15	35	35	75	75	110	125	165	165	200	200	240	285	320
180	200	20	40	40	80	80	120	140	180	180	220	220	260	315	355
200	225	20	45	45	90	90	135	155	200	200	240	240	285	350	395
225	250	25	50	50	100	100	150	170	215	215	265	265	315	380	430
250	280	25	55	55	110	110	165	185	240	240	295	295	350	420	475
280	315	30	60	60	120	120	180	205	265	265	325	325	385	470	530
315	355	30	65	65	135	135	200	225	295	295	360	360	430	520	585
355	400	35	75	75	150	150	225	255	330	330	405	405	480	585	660
400	450	45	85	85	170	170	255	285	370	370	455	455	540	650	735
450	500	50	95	95	190	190	285	315	410	410	505	505	600	720	815
500	560	–	–	105	210	210	315	350	455	455	560	560	665	–	–
560	630	–	–	115	230	230	345	390	505	505	620	620	735	–	–
630	710	–	–	130	260	260	390	435	565	565	695	695	825	–	–
710	800	–	–	145	290	290	435	485	630	630	775	775	920	–	–
800	900	–	–	160	320	320	480	540	700	700	860	860	1 020	–	–
900	1 000	–	–	180	360	360	540	600	780	780	960	960	1 140	–	–

[Note] 1) Clearance C9NA should be applied to tapered cylindrical roller bearings of JIS tolerance classes 5 and 4.

Table 4-5 Radial internal clearance of double / four-row and matched pair tapered roller bearings

(1) Cylindrical bore bearings

Unit : μm

Nominal bore diameter <i>d</i> , mm		Clearance									
		C 1		C 2		C N		C 3		C 4	
over	up to	min.	max.	min.	max.	min.	max.	min.	max.	min.	max.
80	100	0	20	20	45	45	70	70	100	100	130
100	120	0	25	25	50	50	80	80	110	110	150
120	140	0	30	30	60	60	90	90	120	120	170
140	160	0	30	30	65	65	100	100	140	140	190
160	180	0	35	35	70	70	110	110	150	150	210
180	200	0	40	40	80	80	120	120	170	170	230
200	225	0	40	40	90	90	140	140	190	190	260
225	250	0	50	50	100	100	150	150	210	210	290
250	280	0	50	50	110	110	170	170	230	230	320
280	315	0	60	60	120	120	180	180	250	250	350
315	355	0	70	70	140	140	210	210	280	280	390
355	400	0	70	70	150	150	230	230	310	310	440
400	450	0	80	80	170	170	260	260	350	350	490
450	500	0	90	90	190	190	290	290	390	390	540
500	560	0	100	100	210	210	320	320	430	430	590
560	630	0	110	110	230	230	350	350	480	480	660
630	710	0	130	130	260	260	400	400	540	540	740
710	800	0	140	140	290	290	450	450	610	610	830
800	900	0	160	160	330	330	500	500	670	670	920
900	1 000	0	180	180	370	370	550	550	730	730	990
1 000	1 250	0	200	200	420	420	610	610	790	790	1 050
1 250	1 600	0	220	220	460	460	650	650	850	850	1 100
1 600	2 000	0	240	240	480	480	680	680	900	900	1 150

(2) Tapered bore bearings

Unit : μm

Nominal bore diameter <i>d</i> , mm		Clearance									
		C 1		C 2		C N		C 3		C 4	
over	up to	min.	max.	min.	max.	min.	max.	min.	max.	min.	max.
80	100	20	45	45	70	70	100	100	130	130	170
100	120	25	50	50	80	80	110	110	150	150	200
120	140	30	60	60	90	90	120	120	170	170	230
140	160	30	65	65	100	100	140	140	190	190	260
160	180	35	70	70	110	110	150	150	210	210	280
180	200	40	80	80	120	120	170	170	230	230	310
200	225	40	90	90	140	140	190	190	260	260	340
225	250	50	100	100	150	150	210	210	290	290	380
250	280	50	110	110	170	170	230	230	320	320	420
280	315	60	120	120	180	180	250	250	350	350	460
315	355	70	140	140	210	210	280	280	390	390	510
355	400	70	150	150	230	230	310	310	440	440	580
400	450	80	170	170	260	260	350	350	490	490	650
450	500	90	190	190	290	290	390	390	540	540	720
500	560	100	210	210	320	320	430	430	590	590	790
560	630	110	230	230	350	350	480	480	660	660	880
630	710	130	260	260	400	400	540	540	740	740	990
710	800	140	290	290	450	450	610	610	830	830	1 100
800	900	160	330	330	500	500	670	670	920	920	1 240

4. Internal clearance

Table 4-6 Radial internal clearance of spherical roller bearings

(1) Cylindrical bore bearings

Unit :  $\mu\text{m}$

Nominal bore diameter <i>d</i> , mm		Clearance									
		C 2		C N		C 3		C 4		C 5	
over	up to	min.	max.	min.	max.	min.	max.	min.	max.	min.	max.
80	100	35	60	60	100	100	135	135	180	180	225
100	120	40	75	75	120	120	160	160	210	210	260
120	140	50	95	95	145	145	190	190	240	240	300
140	160	60	110	110	170	170	220	220	280	280	350
160	180	65	120	120	180	180	240	240	310	310	390
180	200	70	130	130	200	200	260	260	340	340	430
200	225	80	140	140	220	220	290	290	380	380	470
225	250	90	150	150	240	240	320	320	420	420	520
250	280	100	170	170	260	260	350	350	460	460	570
280	315	110	190	190	280	280	370	370	500	500	630
315	355	120	200	200	310	310	410	410	550	550	690
355	400	130	220	220	340	340	450	450	600	600	750
400	450	140	240	240	370	370	500	500	660	660	820
450	500	140	260	260	410	410	550	550	720	720	900
500	560	150	280	280	440	440	600	600	780	780	1 000
560	630	170	310	310	480	480	650	650	850	850	1 100
630	710	190	350	350	530	530	700	700	920	920	1 190
710	800	210	390	390	580	580	770	770	1 010	1 010	1 300
800	900	230	430	430	650	650	860	860	1 120	1 120	1 440
900	1 000	260	480	480	710	710	930	930	1 220	1 220	1 570
1 000	1 120	290	530	530	780	780	1 020	1 020	1 330	1 330	1 720
1 120	1 250	320	580	580	860	860	1 120	1 120	1 460	1 460	1 870
1 250	1 400	350	640	640	950	950	1 240	1 240	1 620	1 620	2 060
1 400	1 600	400	720	720	1 060	1 060	1 380	1 380	1 800	1 800	2 300
1 600	1 800	450	810	810	1 180	1 180	1 550	1 550	2 000	2 000	2 550

(2) Tapered bore bearings

Unit :  $\mu\text{m}$

Nominal bore diameter <i>d</i> , mm		Clearance									
		C 2		C N		C 3		C 4		C 5	
over	up to	min.	max.	min.	max.	min.	max.	min.	max.	min.	max.
80	100	55	80	80	110	110	140	140	180	180	230
100	120	65	100	100	135	135	170	170	220	220	280
120	140	80	120	120	160	160	200	200	260	260	330
140	160	90	130	130	180	180	230	230	300	300	380
160	180	100	140	140	200	200	260	260	340	340	430
180	200	110	160	160	220	220	290	290	370	370	470
200	225	120	180	180	250	250	320	320	410	410	520
225	250	140	200	200	270	270	350	350	450	450	570
250	280	150	220	220	300	300	390	390	490	490	620
280	315	170	240	240	330	330	430	430	540	540	680
315	355	190	270	270	360	360	470	470	590	590	740
355	400	210	300	300	400	400	520	520	650	650	820
400	450	230	330	330	440	440	570	570	720	720	910
450	500	260	370	370	490	490	630	630	790	790	1 000
500	560	290	410	410	540	540	680	680	870	870	1 100
560	630	320	460	460	600	600	760	760	980	980	1 230
630	710	350	510	510	670	670	850	850	1 090	1 090	1 360
710	800	390	570	570	750	750	960	960	1 220	1 220	1 500
800	900	440	640	640	840	840	1 070	1 070	1 370	1 370	1 690
900	1 000	490	710	710	930	930	1 190	1 190	1 520	1 520	1 860
1 000	1 120	530	770	770	1 030	1 030	1 300	1 300	1 670	1 670	2 050
1 120	1 250	570	830	830	1 120	1 120	1 420	1 420	1 830	1 830	2 250
1 250	1 400	620	910	910	1 230	1 230	1 560	1 560	2 000	2 000	2 450
1 400	1 600	680	1 000	1 000	1 350	1 350	1 720	1 720	2 200	2 200	2 700
1 600	1 800	750	1 110	1 110	1 500	1 500	1 920	1 920	2 400	2 400	2 950

## 5. Lubrication

Lubrication is one of the most important factors determining bearing performance. The suitability of the lubricant and lubrication method have a dominant influence on bearing life.

Functions of lubrication :

- To lubricate each part of the bearing, and to reduce friction and wear
- To carry away heat generated inside bearing due to friction and other causes
- To cover rolling contact surface with the proper oil film in order to prolong bearing fatigue life
- To prevent corrosion and contamination by dirt

Bearing lubrication is classified broadly into two categories: grease lubrication and oil lubrication. Table 5-1 makes a general comparison between the two.

**Table 5-1 Comparison between grease and oil lubrication**

Item	Grease	Oil
· Sealing device	Easy	Slightly complicated and special care required for maintenance
· Lubricating ability	Good	Excellent
· Rotation speed	Low/medium speed	Applicable at high speed as well
· Replacement of lubricant	Slightly troublesome	Easy
· Life of lubricant	Relatively short	Long
· Cooling effect	No cooling effect	Good (circulation is necessary)
· Filtration of dirt	Difficult	Easy

### 5-1 Grease lubrication

Grease lubrication is widely applied since there is no need for replenishment over a long period once grease is filled, and a relatively simple structure can suffice for the lubricant sealing device.

There are two methods of grease lubrication. One is the closed lubrication method, in which grease is filled in advance into shielded/sealed bearing; the other is the feeding method, in which the bearing and housing are filled with grease in proper quantities at first, and refilled at a regular interval via replenishment or replacement.

Devices with numerous grease inlets sometimes employ the centralized lubricating method, in which the inlets are connected via piping and supplied with grease collectively.

#### 1) Amount of grease

In general, grease should fill approximately one-third to one-half the inside space, though this varies according to structure and inside space of housing.

It must be borne in mind that excessive grease will generate heat when churned, and will consequently alter, deteriorate, or soften.

When the bearing is operated at low speed, however, the inside space is sometimes filled with grease to two-thirds to full, in order to preclude infiltration of contaminants.

#### 2) Replenishment/replacement of grease

The method of replenishing/replacing grease depends largely on the lubrication method. Whichever method may be utilized, care should be taken to use clean grease and to keep dirt or other foreign matter out of the housing.

In addition, it is desirable to refill with grease of the same brand as that filled at the start. When grease is refilled, new grease must be injected inside bearing.

Fig. 5-1 gives one example of a feeding method.

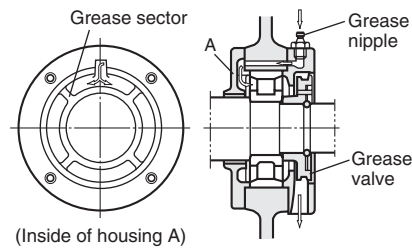

**Fig. 5-1 Example of grease feeding method (using grease sector)**

In the example, the inside of the housing is divided by grease sectors. Grease fills one sector, then flows into the bearing.

On the other hand, grease flowing back from the inside is forced out of the bearing by the centrifugal force of the grease valve.

When the grease valve is not used, it is necessary to enlarge the housing space on the discharge side to store old grease.

The housing is uncovered and the stored old grease is removed at regular intervals.

#### 3) Grease feeding interval

In normal operation, grease life should be regarded roughly as shown in Fig. 5-2, and replenishment/replacement should be carried out accordingly.

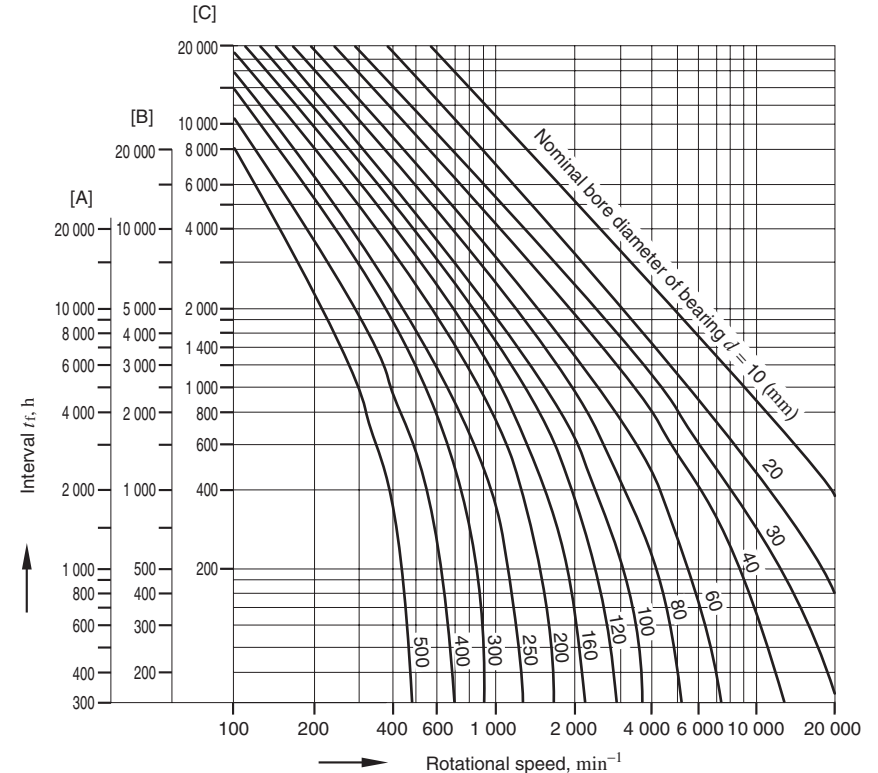

[Notes] 1) [A] : radial ball bearing

2) Temperature correction

[B] : cylindrical roller bearing, needle roller bearing

When the bearing operating temperature exceeds 70 °C,  $t_f'$ , obtained by multiplying  $t_f$  by correction coefficient  $a$ , found on the scale below, should be applied as the feeding interval.

[C] : tapered roller bearing, spherical roller bearing, thrust ball bearing

$$t_f' = t_f \times a$$

Temperature correction coefficient  $a$

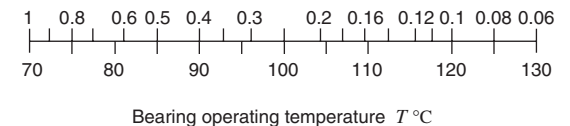

**Fig. 5-2 Grease feeding interval**

5-2 Oil lubrication

Oil lubrication is usable even at high speed rotation and somewhat high temperature, and is effective in reducing bearing vibration and noise.

Thus oil lubrication is used in many cases where grease lubrication does not work.

Table 5-2 shows major types and methods of oil lubrication.

Table 5-2 Type and method of oil lubrication

<p>(1) Oil bath</p>	<ul style="list-style-type: none"> <li>Simplest method of bearing immersion in oil for operation.</li> <li>Suitable for low/medium speed.</li> <li>Oil level gauge should be furnished to adjust the amount of oil. (In the case of horizontal shaft) About 50 % of the lowest rolling element should be immersed. (In the case of vertical shaft) About 70 to 80 % of the bearing should be immersed.</li> <li>It is better to use a magnetic plug to prevent wear iron particles from dispersing in oil.</li> </ul>	<p>a magnetic plug</p>
<p>(2) Oil drip</p>	<ul style="list-style-type: none"> <li>Oil is dripped with an oiling device, and the inside of the housing is filled with oil mist by the action of rotating parts. This method has a cooling effect.</li> <li>Applicable at relatively high speed and up to medium load.</li> <li>In general, 5 to 6 drops of oil are utilized per minute. (It is difficult to adjust the dripping in 1 mL/h or smaller amounts.)</li> <li>It is necessary to prevent too much oil from being accumulated at the bottom of housing.</li> </ul>	
<p>(3) Oil splash</p>	<ul style="list-style-type: none"> <li>This type of lubrication method makes use of a gear or simple flinger attached to shaft in order to splash oil. This method can supply oil for bearings located away from the oil tank.</li> <li>Usable up to relatively high speed.</li> <li>It is necessary to keep oil level within a certain range.</li> <li>It is better to use a magnetic plug to prevent wear iron particles from dispersing in oil. It is also advisable to set up a shield or baffle board to prevent contaminants from entering the bearing.</li> </ul>	

<p>(4) Forced oil circulation</p>	<ul style="list-style-type: none"> <li>This method employs a circulation-type oil supply system. Supplied oil lubricates inside of the bearing, is cooled and sent back to the tank through an oil escape pipe. The oil, after filtering and cooling, is pumped back.</li> <li>Widely used at high speeds and high temperature conditions.</li> <li>It is better to use an oil escape pipe approximately twice as thick as the oil supply pipe in order to prevent too much lubricant from gathering in housing.</li> <li>Required amount of oil : see Remark 1 (on page 56).</li> </ul>	
<p>(5) Oil jet lubrication</p>	<ul style="list-style-type: none"> <li>This method uses a nozzle to jet oil at a constant pressure (0.1 to 0.5 MPa), and is highly effective in cooling.</li> <li>Suitable for high speed and heavy load.</li> <li>Generally, the nozzle (diameter 0.5 to 2 mm) is located 5 to 10 mm from the side of a bearing. When a large amount of heat is generated, 2 to 4 nozzles should be used.</li> <li>Since a large amount of oil is supplied in the jet lubrication method, old should be discharged with an oil pump to prevent excessive residual oil.</li> <li>Required amount of oil : see Remark 1 (on page 56).</li> </ul>	
<p>(6) Oil mist lubrication (spray lubrication)</p>	<ul style="list-style-type: none"> <li>This method employs an oil mist generator to produce dry mist (air containing oil in the form of mist). The dry mist is continuously sent to the oil supplier, where the mist is turned into a wet mist (sticky oil drops) by a nozzle set up on the housing or bearing, and is then sprayed onto bearing.</li> <li>Required amount of mist : see Remark 2 (on page 57).</li> </ul> <p>(Example of grinding machine)</p>	<ul style="list-style-type: none"> <li>This method provides and sustains the smallest amount of oil film necessary for lubrication, and has the advantages of preventing oil contamination, simplifying bearing maintenance, prolonging bearing fatigue life, reducing oil consumption etc.</li> </ul> <p>(Example of rolling mill)</p>

(7)  
Oil / air  
lubrication

- A proportioning pump sends forth a small quantity of oil, which is mixed with compressed air by a mixing valve. The admixture is supplied continuously and stably to the bearing.
- This method enables quantitative control of oil in extremely small amounts, always supplying new lubricating oil. It is thus suitable for machine tools and other applications requiring high speed.
- Compressed air and lubricating oil are supplied to the spindle, increasing the internal pressure and helping prevent dirt, cutting-liquid, etc. from entering. As well, this method allows the lubricating oil to flow through a feeding pipe, minimizing atmospheric pollution.

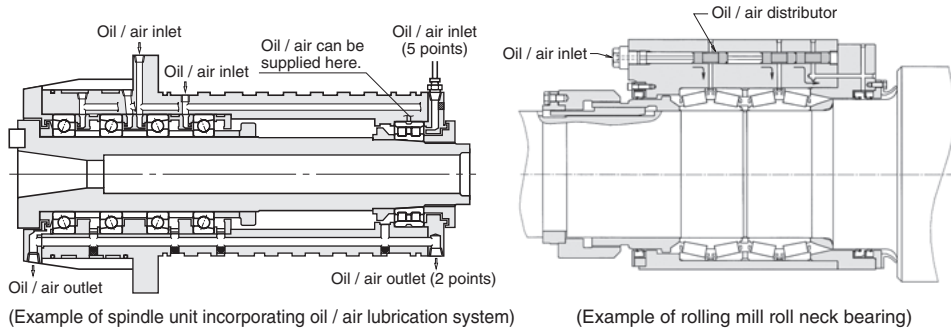

**Remark 1** Required oil supply in forced oil circulation ; oil jet lubrication methods

$$G = \frac{1.88 \times 10^{-4} \mu \cdot d \cdot n \cdot P}{60 \cdot c \cdot r \cdot \Delta T}$$

where :

- $G$  : required oil supply L/min
- $\mu$  : friction coefficient (see table at right)
- $d$  : nominal bore diameter mm
- $n$  : rotational speed  $\text{min}^{-1}$
- $P$  : dynamic equivalent load of bearing N
- $c$  : specific heat of oil 1.88–2.09kJ/kg·K
- $r$  : density of oil  $\text{g/cm}^3$
- $\Delta T$  : temperature rise of oil K

Values of friction coefficient  $\mu$

Bearing type	$\mu$
Deep groove ball bearing	0.001 0 – 0.001 5
Angular contact ball bearing	0.001 2 – 0.002 0
Cylindrical roller bearing	0.000 8 – 0.001 2
Tapered roller bearing	0.001 7 – 0.002 5
Spherical roller bearing	0.002 0 – 0.002 5

The values obtained by the above equation show quantities of oil required to carry away all the generated heat, with heat release not taken into consideration.

In reality, the oil supplied is generally half to two-thirds of the calculated value.

Heat release varies widely according to the application and operating conditions.

To determine the optimum oil supply, it is advised to start operating with two-thirds of the calculated value, and then reduce the oil gradually while measuring the operating temperature of bearing, as well as the supplied and discharged oil.

**Remark 2** Notes on oil mist lubrication

1) Required amount of mist (mist pressure : 5 kPa)

$$\text{(In the case of a bearing)} \quad Q = \frac{0.11dR}{1000}$$

$$\text{(In the case of two oil seals combined)} \quad Q = \frac{0.028d_1}{1000}$$

where :

- $Q$  : required amount of mist L/min
- $d$  : nominal bore diameter mm
- $R$  : number of rolling element rows
- $d_1$  : inside diameter of oil seal mm

In the case of high speed ( $d_m n \geq 400 \times 10^3$ ), it is necessary to increase the amount of oil and heighten the mist pressure.

2) Piping diameter and design of lubrication hole/groove

When the flow rate of mist in piping exceeds 5 m/s, oil mist suddenly condenses into an oil liquid.

Consequently, the piping diameter and dimensions of the lubrication hole/groove in the housing should be designed to keep the flow rate of mist, obtained by the following equation, from exceeding 5 m/s.

$$V = \frac{0.167Q}{A} \leq 5$$

where :

- $V$  : flow rate of mist m/s
- $Q$  : amount of mist L/min
- $A$  : sectional area of piping or lubrication groove  $\text{cm}^2$

3) Mist oil

Oil used in oil mist lubrication should meet the following requirements.

- ability to turn into mist
- has high extreme pressure resistance
- good heat/oxidation stability
- rust-resistant
- unlikely to generate sludge
- superior demulsifier

Oil mist lubrication has a number of advantages for high speed rotation bearings. Its performance, however, is largely affected by surrounding structures and bearing operating conditions.

If contemplating the use of this method, please contact with JTEKT for advice based on JTEKT long experience with oil mist lubrication.

**Remark 3** Required oil supply in oil / air lubrication (Rolling mill roll neck bearing)

$$\text{Horizontal roll} \quad Q = \frac{0.085dR}{A}$$

$$\text{Vertical roll} \quad Q = \frac{0.170dR}{A}$$

where :

- $Q$  : Required oil supply  $\text{cm}^3/\text{h}$
- $d$  : Nominal bore diameter mm
- $R$  : Number of rolling element rows
- $A$  : Coefficient (low speed : 10, high speed : 5)

5. Lubrication

5-3 Lubricant

5-3-1 Grease

Grease is made by mixing and dispersing a solid of high oil-affinity (called a thickener) with lubricant oil (as a base), and transforming it into a semi-solid state.

As well, a variety of additives can be added to improve specific performance.

(1) Base oil

Mineral oil is usually used as the base oil for grease. When low temperature fluidity, high temperature stability, or other special performance is required, diester oil, silicon oil, polyglycolic oil, fluorinated oil, or other synthetic oil is often used.

Generally, grease with a low viscosity base oil is suitable for applications at low temperature or high rotation speed; grease with high viscosity base oils are suitable for applications at high temperature or under heavy load.

(2) Thickener

Most greases use a metallic soap base such as lithium, sodium, or calcium as thickeners. For some applications, however, non-soap base thickeners (inorganic substances such as bentone, silica gel, and organic substances such as urea compounds, fluorine compounds) are also used.

In general, the mechanical stability, bearing operating temperature range, water resistance, and other characteristics of grease are determined by the thickener.

(Lithium soap base grease)

Superior in heat resistance, water resistance and mechanical stability.

(Calcium soap base grease)

Superior in water resistance; inferior in heat resistance.

(Sodium soap base grease)

Superior in heat resistance; inferior in water resistance.

(Non-soap base grease)

Superior in heat resistance.

(3) Additives

Various additives are selectively used to serve the respective purposes of grease applications.

- Extreme pressure agents

When bearings must tolerate heavy or impact loads.

- Oxidation inhibitors

When grease is not refilled for a long period. Structure stabilizers, rust preventives, and corrosion inhibitors are also used.

(4) Consistency

Consistency, which indicates grease hardness, is expressed as a figure obtained, in accordance with ASTM (JIS), by multiplication by 10 the depth (in mm) to which the cone-shaped metallic plunger penetrates into the grease at 25 °C by deadweight in 5 seconds. The softer the grease, the higher the figure.

Table 5-4 shows the relationships between the NLGI scales and ASTM (JIS) penetration indexes, service conditions of grease.

(NLGI : National Lubricating Grease Institute)

Table 5-4 Grease consistency

NLGI scale	ASTM (JIS) penetration index (25 °C, 60 mixing operations)	Service conditions/ applications
0	355 – 385	For centralized lubricating
1	310 – 340	For centralized lubricating, at low temperature
2	265 – 295	For general use
3	220 – 250	For general use, at high temperature
4	175 – 205	For special applications

(5) Mixing of different greases

Since mixing of different greases changes their properties, greases of different brands should not be mixed.

If mixing cannot be avoided, greases containing the same thickener should be used. Even if the mixed greases contain the same thickener, however, mixing may still produce adverse effects, due to difference in additives or other factors.

Thus it is necessary to check the effects of a mixture in advance, through testing or other methods.

Table 5-3 Characteristics of respective greases

	Lithium grease			Calcium grease (cup grease)	Sodium grease (fiber grease)		Complex base grease		Non-soap base grease			
	Mineral oil	Synthetic oil (diester oil)	Synthetic oil (silicon oil)	Calcium soap	Sodium soap		Lithium complex soap	Calcium complex soap	Bentone	Urea compounds	Fluorine compounds	
Thickener	Lithium soap			Calcium soap	Sodium soap		Mineral oil	Mineral oil	Mineral oil	Mineral/synthetic oil	Synthetic oil	Base oil
Base oil	Mineral oil	Synthetic oil (diester oil)	Synthetic oil (silicon oil)	Mineral oil	Mineral oil		250 or higher	200 to 280	–	240 or higher	250 or higher	Dropping point (°C)
Dropping point (°C)	170 to 190	170 to 230	220 to 260	80 to 100	160 to 180		– 30 to + 150	– 10 to + 130	– 10 to + 150	– 30 to + 150	– 40 to + 250	Operating temperature range (°C)
Operating temperature range (°C)	– 30 to + 120	– 50 to + 130	– 50 to + 180	– 10 to + 70	0 to + 110		Low to high	Low to medium	Medium to high	Low to high	Low to medium	Rotation speed range
Rotation speed range	Medium to high	High	Low to medium	Low to medium	Low to high		Good to excellent	Good	Good	Good to excellent	Good	Mechanical stability
Mechanical stability	Excellent	Good to excellent	Good	Fair to good	Good to excellent		Good to excellent	Good	Good	Good to excellent	Good	Water resistance
Water resistance	Good	Good	Good	Good	Bad		Good	Good	Good to excellent	Good to excellent	Good	Pressure resistance
Pressure resistance	Good	Fair	Bad to fair	Fair	Good to excellent		Superior mechanical stability and heat resistance. Used at relatively high temperature.	Superior pressure resistance when extreme pressure agent is added. Used in bearings for rolling mills.	Suitable for applications at high temperature and under relatively heavy load.	Superior water resistance, oxidation stability, and heat stability. Suitable for applications at high temperature and high speed.	Superior chemical resistance and solvent resistance. Usable at up to 250 °C.	Remarks
Remarks	Most widely usable for various rolling bearings.	Superior low temperature and friction characteristics. Suitable for bearings for measuring instruments and extra-small ball bearings for small electric motors.	Superior high and low temperature characteristics.	Suitable for applications at low rotation speed and under light load. Not applicable at high temperature.	Liable to emulsify in the presence of water. Used at relatively high temperature.							



5. Lubrication

5-3-2 Lubricating oil

For lubrication, bearings usually employ highly refined mineral oils, which have superior oxidation stability, rust-preventive effect, and high film strength.

With bearing diversification, however, various synthetic oils have been put into use.

These synthetic oils contain various additives (oxidation inhibitors, rust preventives, antifoaming agents, etc.) to improve specific properties. Table 5-5 shows the characteristics of lubricating oils.

Mineral lubricating oils are classified by applications in JIS and MIL.

Table 5-5 Characteristics of lubricating oils

Type of lubricating oil	Highly refined mineral oil	Major synthetic oils				
		Diester oil	Silicon oil	Polyglycolic oil	Polyphenyl ether oil	Fluorinated oil
Operating temperature range (°C)	-40 to +220	-55 to +150	-70 to +350	-30 to +150	0 to +330	-20 to +300
Lubricity	Excellent	Excellent	Fair	Good	Good	Excellent
Oxidation stability	Good	Good	Fair	Fair	Excellent	Excellent
Radioactivity resistance	Bad	Bad	Bad to fair	Bad	Excellent	-

[Selection of lubricating oil]

The most important criterion in selecting a lubricating oil is whether the oil provides proper viscosity at the bearing operating temperature.

Standard values of proper kinematic viscosity can be obtained through selection by bearing type according to Table 5-6 first, then through selection by bearing operating conditions according to Table 5-7.

When lubricating oil viscosity is too low, the oil film will be insufficient. On the other hand, when the viscosity is too high, heat will be generated due to viscous resistance.

In general, the heavier the load and the higher the operating temperature, the higher the lubricating oil viscosity should be; whereas, the higher the rotation speed, the lower the viscosity should be.

Fig. 5-3 illustrates the relationship between lubricating oil viscosity and temperature.

Table 5-6 Proper kinematic viscosity by bearing type

Bearing type	Proper kinematic viscosity at operating temperature
Ball bearing Cylindrical roller bearing	13 mm <sup>2</sup> /s or higher
Tapered roller bearing Spherical roller bearing	20 mm <sup>2</sup> /s or higher
Spherical thrust roller bearing	32 mm <sup>2</sup> /s or higher

Table 5-7 Proper kinematic viscosities by bearing operating conditions

Operating temperature	d <sub>m</sub> n value	Proper kinematic viscosity (expressed in the ISO viscosity grade or the SAE No.)	
		Light/normal load	Heavy/impact load
-30 ~ 0 °C	All rotation speeds	ISO VG 15, 22, 46 (Refrigerating machine oil)	-
	300 000 or lower	ISO VG 46 (Bearing oil Turbine oil)	ISO VG 68 (Bearing oil Turbine oil) SAE 30
0 ~ 60 °C	300 000 to 600 000	ISO VG 32 (Bearing oil Turbine oil)	ISO VG 68 (Bearing oil Turbine oil)
	600 000 or higher	ISO VG 7, 10, 22 (Bearing oil)	-
	300 000 or lower	ISO VG 68 (Bearing oil)	ISO VG 68, 100 (Bearing oil) SAE 30
60 ~ 100 °C	300 000 to 600 000	ISO VG 32, 46 (Bearing oil Turbine oil)	ISO VG 68 (Bearing oil Turbine oil)
	600 000 or higher	ISO VG 22, 32, 46 (Bearing oil Turbine oil Machine oil)	-
	300 000 or lower	ISO VG 68, 100 (Bearing oil) SAE 30, 40	ISO VG 100 ~ 460 (Bearing oil Gear oil)
100 ~ 150 °C	300 000 to 600 000	ISO VG 68 (Bearing oil Turbine oil) SAE 30	ISO VG 68, 100 (Bearing oil) SAE 30, 40

- [Remarks] 1.  $d_m n = \frac{D+d}{2} \times n$  ..... { D : nominal outside diameter (mm), d : nominal bore diameter (mm), n : rotational speed (min<sup>-1</sup>) }
2. Refer to refrigerating machine oil (JIS K 2211), turbine oil (JIS K 2213), gear oil (JIS K 2219), machine oil (JIS K 2238) and bearing oil (JIS K 2239).
3. Please contact with JTEKT if the bearing operating temperature is under -30 °C or over 150 °C .

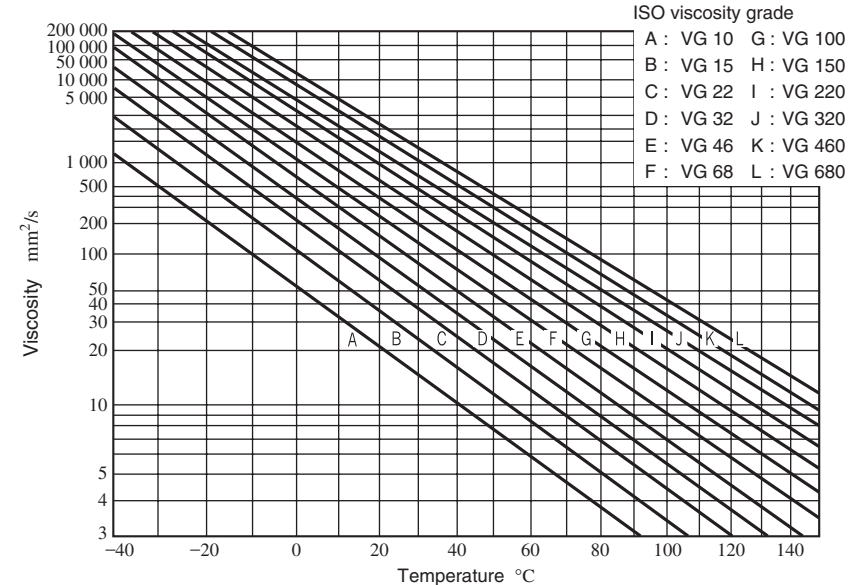

Fig. 5-3 Relationship between lubricating oil viscosity and temperature (viscosity index : 100)

## 6. Bearing materials

Bearing materials include steel for bearing rings and rolling elements, as well as steel sheet, steel, copper alloy and synthetic resins for cages.

These bearing materials should possess the following characteristics :

- |  |  |
|--|--|
| 1) High elasticity, durable under high partial contact stress.                         | } Bearing rings                                  |
| 2) High strength against rolling contact fatigue due to large repetitive contact load. |  |
| 3) Strong hardness   | } Rolling elements                               |
| 4) High abrasion resistance  |  |
| 5) High toughness against impact load  | } Bearing rings<br>} Rolling elements<br>} Cages |
| 6) Excellent dimensional stability   |  |

### 6-1 Bearing rings and rolling elements materials

#### 1) High carbon chromium bearing steel

High carbon chromium bearing steel specified in JIS is used as a general material in bearing rings (inner rings, outer rings) and rolling elements (balls, rollers).

Their chemical composition classified by steel type is given in Table 6-1.

Among these steel types, SUJ 2 is generally used. SUJ 3, which contains additional Mn and Si, possesses high hardenability and is commonly used for thick section bearings.

SUJ 5 has increased hardenability, because it was developed by adding Mo to SUJ 3.

For small and medium size bearings, SUJ 2 and SUJ 3 are used, and for large size and extra-large size bearings with thick sections, SUJ 5 is widely used.

Generally, these materials are processed into the specified shape and then undergo hardening and annealing treatment until they attain a hardness of 57 to 64 HRC.

Table 6-1 Chemical composition of high carbon chromium bearing steel

Standard	Code	Chemical composition (%)							
		C	Si	Mn	P	S	Cr	Mo	
JIS G 4805	SUJ 2	0.95 ~ 1.10	0.15 ~ 0.35	Not more than 0.50	Not more than 0.025	Not more than 0.025	1.30 ~ 1.60	Not more than 0.08	
	SUJ 3		0.40 ~ 0.70	0.90 ~ 1.15				0.90 ~ 1.20	Not more than 0.08
	SUJ 5		0.40 ~ 0.70	0.90 ~ 1.15				0.90 ~ 1.20	0.10 ~ 0.25
SAE J 404	52100	0.98 ~ 1.10	0.15 ~ 0.35	0.25 ~ 0.45	Not more than 0.025	Not more than 0.025	1.30 ~ 1.60	Not more than 0.06	

[Remark] As for bearings which are induction hardened, carbon steel with a high carbon content of 0.55 to 0.65 % is used in addition to those listed in this table.

#### 2) Case carburizing bearing steel (case hardened steel)

When a bearing receives heavy impact loads, the surface of the bearing should be hard and the inside soft.

Such materials should possess a proper amount of carbon, dense structure, and carburizing case depth on their surface, while having proper hardness and fine structure internally.

For this purpose, chromium steel and nickel-chromium-molybdenum steel are used as materials.

Typical steel materials are shown in Table 6-2.

These materials also undergo vacuum degassing in order to reduce non-metallic inclusions and oxygen content which leads to higher reliability.

#### 3) Others

For special applications, the following materials are used, according to operational conditions.

(When very high reliability is required)

- high refining steel ... developed by JTEKT
- vacuum arc remelted steel
- electro slag remelted steel

(When heat resistance is required)

- high speed steel for high temperature bearings ... refer to Table 6-3

(When high corrosion resistance is required)

- stainless steel ... refer to Table 6-4

(When high heat, corrosion, and chemical resistance are required)

- ceramics

Table 6-2 Chemical composition of case carburizing bearing steel

Standard	Code	Chemical composition (%)							
		C	Si	Mn	P	S	Ni	Cr	Mo
JIS G 4053	SCr 415	0.13 ~ 0.18	0.15 ~ 0.35	0.60 ~ 0.85	Not more than 0.030	Not more than 0.030	–	0.90 ~ 1.20	–
	SCr 420	0.18 ~ 0.23		0.60 ~ 0.85			–	0.90 ~ 1.20	–
	SCM 420	0.18 ~ 0.23		0.60 ~ 0.85			–	0.90 ~ 1.20	0.15 ~ 0.30
	SNCM 220	0.17 ~ 0.23		0.60 ~ 0.90			0.40 ~ 0.70	0.40 ~ 0.65	0.15 ~ 0.30
	SNCM 420	0.17 ~ 0.23		0.40 ~ 0.70			1.60 ~ 2.00	0.40 ~ 0.65	0.15 ~ 0.30
	SNCM 815	0.12 ~ 0.18		0.30 ~ 0.60			4.00 ~ 4.50	0.70 ~ 1.00	0.15 ~ 0.30
SAE J 404	5120	0.17 ~ 0.22	0.15 ~ 0.35	0.70 ~ 0.90	Not more than 0.035	Not more than 0.040	–	0.70 ~ 0.90	–
	8620	0.18 ~ 0.23		0.70 ~ 0.90			0.40 ~ 0.70	0.40 ~ 0.60	0.15 ~ 0.25
	4320	0.17 ~ 0.22	0.15 ~ 0.30	0.45 ~ 0.65	Not more than 0.025	Not more than 0.025	1.65 ~ 2.00	0.40 ~ 0.60	0.20 ~ 0.30

Table 6-3 Chemical composition of high speed steel for high temperature bearings

Standard	Code	Chemical composition (%)											
		C	Si	Mn	P	S	Cr	Mo	V	Ni	Cu	Co	W
AISI	M 50	0.77 ~ 0.85	Not more than 0.25	Not more than 0.35	Not more than 0.015	Not more than 0.015	3.75 ~ 4.25	4.00 ~ 4.50	0.90 ~ 1.10	Not more than 0.10	Not more than 0.10	Not more than 0.25	Not more than 0.25

Table 6-4 Chemical composition of stainless steel

Standard	Code	Chemical composition (%)						
		C	Si	Mn	P	S	Cr	Mo
JIS G 4303	SUS 440 C	0.95 ~ 1.20	Not more than 1.00	Not more than 1.00	Not more than 0.040	Not more than 0.030	16.00 ~ 18.00	Not more than 0.75

6. Bearing materials

6-2 Materials used for cages

Since the characteristics of materials used for cages greatly influence the performance and reliability of rolling bearings, the choice of materials is of great importance.

It is necessary to select cage materials in accordance with required shape, ease of lubrication, strength, and abrasion resistance.

Typical materials used for metallic cages are shown in Tables 6-5 and 6-6.

In addition, phenolic resin machined cages and other synthetic resin molded cages are often used.

Materials typically used for molded cages are polyacetal, polyamide (Nylon 6.6, Nylon 4.6), and polymer containing fluorine, which are strengthened with glass and carbon fibers.

Table 6-5 Chemical compositions of pressed cage steel sheet (A) and machined cage carbon steel (B)

	Standard	Code	Chemical composition (%)						
			C	Si	Mn	P	S	Ni	Cr
(A)	JIS G 3141	SPCC	Not more than 0.12	-	Not more than 0.50	Not more than 0.040	Not more than 0.045	-	-
	JIS G 3131	SPHC	Not more than 0.15	-	Not more than 0.60	Not more than 0.050	Not more than 0.050	-	-
	BAS 361	SPB 2	0.13 ~ 0.20	Not more than 0.04	0.25 ~ 0.60	Not more than 0.030	Not more than 0.030	-	-
	JIS G 4305	SUS 304	Not more than 0.08	Not more than 1.00	Not more than 2.00	Not more than 0.045	Not more than 0.030	8.00 ~ 10.50	18.00 ~ 20.00
(B)	JIS G 4051	S 25 C	0.22 ~ 0.28	0.15 ~ 0.35	0.30 ~ 0.60	Not more than 0.030	Not more than 0.035	-	-

Table 6-6 Chemical composition of high-tensile brass casting of machined cages (%)

Standard	Code	Cu	Zn	Mn	Fe	Al	Sn	Ni	Impurity	
									Pb	Si
JIS H 5120	CAC 301 (HBsC*)	55 ~ 60	33 ~ 42	0.1 ~ 1.5	0.5 ~ 1.5	0.5 ~ 1.5	Not more than 1.0	Not more than 1.0	Not more than 0.4	Not more than 1.0

\* : Material with HBsC is used.

7. Examples of failures

Table 7-1 (1) Bearing failures, causes and countermeasures





Failures	Characteristics	Damages		Causes	Countermeasures
(1) Flaking	 <p>Flaking caused by excessive axial load</p> <p>Inner ring of four-row tapered roller bearing</p>	Flaking on bearing raceway surface generated on only rows receiving axial load		1) Crossed work rolls causing excessive axial load <ul style="list-style-type: none"> <li>· Roll neck diameter is smaller than the standard one.</li> <li>· Chock side liner is worn.</li> <li>· Inaccuracy of mill stand.</li> <li>· Rigidity of the chock is poor.</li> <li>· Corrosion on liner or clearance generated between the liner and the chock.</li> <li>· Failure of the keeper plate.</li> </ul>	1) Keep the correct locations of the chock and work roll.
	 <p>Outer ring raceway of four-row tapered roller bearing</p>	Flaking generated and developed from raceway end face		1) Looseness of chock cover/excessive axial clearance <p style="margin-left: 20px;">( As the axial clearance is increased, the loading range becomes narrower, partial load acts, and edge load is generated on the outer ring raceway. )</p> 2) Excessive axial clearance is generated because of the mixed use of other bearing spacer or outer ring.	1) Adjust shims, select thickness of shims, measure a gap, and tighten bolts correctly. 2) Use parts of the same number.
	<p>Flaking caused by improper mounting</p> <p>Loading position (1)    Loading position (2)</p>  <p>1st row 2nd row 3rd row 4th row</p> <p>(1)    (2)</p> <p>(2)    (4)    (3)</p> <p>Loading position (3)    Loading position (4)</p>  <p>Outer ring raceway of four-row tapered roller bearing</p>	Flaking on raceway surface with slanted contact		1) It occurs when the chock is fixed inappropriately and slantingly. <ul style="list-style-type: none"> <li>· Failure of keeper plate</li> <li>Removal, looseness, damage, deformation, bend, unequal tightening, unequal wear, improper parallelism</li> <li>· Damaged, deformed, or bent chock flange</li> </ul>	1) Find the cause of damage by periodic inspection of the chock and stand.
	 <p>Flaking at corroded start point</p> <p>Outer ring raceway of four-row tapered roller bearing</p>	Flaking on raceway surface started from corroded (rusted) portion		1) After the bearing was used, it has been left for a long period with moisture mixed in grease. 2) Improper rust preventive treatment after the bearing was washed. 3) Worn or damaged seal lips 4) Corrosion on the raceway is generated due to the clearance between the roll neck and the sleeve, and flaking occurs with rust.	1) Improve seal maintenance and sealing method. Periodically check for wear or damage on the seal lips. 2) Fit the "O" ring between the roll neck and the sleeve. 3) Immediately after the bearing is removed from the chock, change grease. 4) After washing the bearing, remove kerosene and water completely.

Table 7-1 (2) Bearing failures, causes and countermeasures



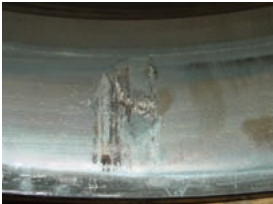

Failures	Characteristics	Damages		Causes	Countermeasures
(1) Flaking	 <p>Flaking on nicks (scratch) start point</p> <p>Rolling contact surface of four-row cylindrical roller bearing</p>	Flaking on rolling contact surface with nicks start point		1) Inappropriate handling · Mounting / dismantling bearing to / from chock · Replacing roll	1) Proper handling jig (use of a copper hammer) 2) Prevention of impact load when replacing roll (use of soft material) 3) Improvement in mounting method 4) Change in raceway chamfering
	 <p>Outer ring raceway of double-row cylindrical roller bearing</p>	Flaking on raceway surface		1) Low viscosity lubrication (improper lubrication) 2) Ingress of dusts and foreign matters	1) Improvement in viscosity of oil and oil type 2) Improvement in seal maintenance and sealing method Periodic check of wear or damage of seal lip 3) Check of oil filter
	  <p>Inner ring raceway of double-row cylindrical roller bearing</p> <p>Inner ring raceway of double-row cylindrical roller bearing</p>				
(2) Cracking Chipping	 <p>Inner ring side face of four-row tapered roller bearing</p>	Minute crack on inner ring side face		1) Fix the inner ring and the roll with a fillet ring (thrust collar). 2) Clearance between the fillet ring (thrust collar) and the inner ring is excessively small. 3) Area of the side face of nut/slinger contacting the inner ring side face is too small, the side face is worn due to inner ring creep, causing heat.	1) Keep the clearance between the inner ring and the fillet ring (thrust collar) (from 0.5 mm to 1.5 mm). 2) Keep the area of the side of fillet ring (thrust collar) (to reduce pressure on the side face). 3) Apply and supply grease of adequate amount.
	 <p>Rolling contact surface of four-row cylindrical roller bearing</p>	Cracking on rolling elements		1) Application of load greater than bearing load rating (Load resistance of roller by use of pin type cage) 2) Secondary factor in case of damaged pin of cage (For a reversible mill, pins are broken due to fatigue caused by rapid acceleration and deceleration) 3) Other factors · Ingress of water due to faulty sealing · Increase of axial clearance of bearing, causing application of partial and excessive load	1) Optimal design of bearing considering load and operating conditions (Examination of optimal cage type) 2) Reviewing sealing method and design of strength of cover

Table 7-1 (3) Bearing failures, causes and countermeasures



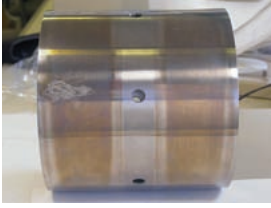
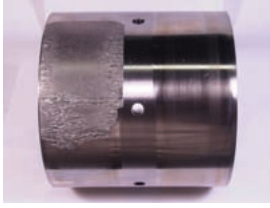

Failures	Characteristics	Damages		Causes	Countermeasures
<p>(2) Cracking Chipping</p>	<div style="display: flex; justify-content: space-around;"> <div style="text-align: center;">  <p>Outer ring outside surface of double-row cylindrical roller bearing</p> </div> <div style="text-align: center;">  <p>Outer ring side face of double-row cylindrical roller bearing</p> </div> </div> <div style="text-align: center; margin-top: 10px;">  <p>Outer ring outside of double-row cylindrical roller bearing</p> </div>	<p>Crack on outer ring</p>		<ol style="list-style-type: none"> <li>1) Impact load acting due to accidents of rolling mill (for example, plate being caught in, ingress of dusts)</li> <li>2) Rolling load acting unevenly due to uneven overall thickness of bearing in the shaft, causing excessive load to a thick section bearing (for multi-roll mill, BUR bearing)</li> </ol>	<ol style="list-style-type: none"> <li>1) Change to outer ring material or heat treated material hard to be cracked.</li> <li>2) Appropriate overall thickness control of bearings in a shaft</li> </ol>
	<div style="display: flex; justify-content: space-around;"> <div style="text-align: center;">  <p>Inner ring raceway of four-row cylindrical roller bearing</p> </div> <div style="text-align: center;">  <p>Inner ring raceway of four-row cylindrical roller bearing</p> </div> </div>	<p>Grinding burn or crack on inner ring raceway surface</p>		<ol style="list-style-type: none"> <li>1) After fitting an inner ring into the roll neck, grinding burn occurs during grinding with the inner ring and the roll.</li> <li>2) Crack occurs because rollers rolling on the raceway surface of which strength (hardness) is decreased due to grinding burn.</li> </ol>	<ol style="list-style-type: none"> <li>1) Reviewing grinding conditions Grain size of grinding stone, grinding stone cutting amount, cutting pressure, grinding fluid amount, etc.</li> </ol>
	<div style="text-align: center;">  <p>Outer ring outside surface of double-row cylindrical roller bearing</p> </div>	<p>Grinding burn or crack on outer ring outside surface</p>		<ol style="list-style-type: none"> <li>1) Grinding burn occurs when re-grinding the outer ring of a multi-roll mill bearing.</li> <li>2) Crack occurs because the outer ring of which strength (hardness) is decreased by grinding burn contacts with the intermediate roll.</li> </ol>	

Table 7-1 (4) Bearing failures, causes and countermeasures



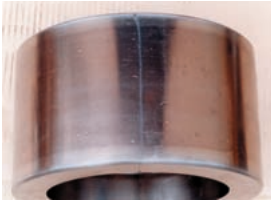
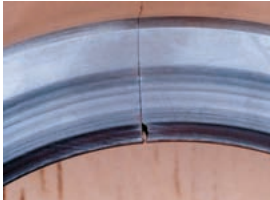

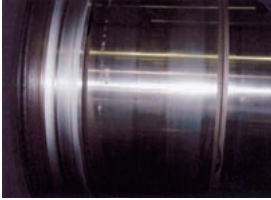

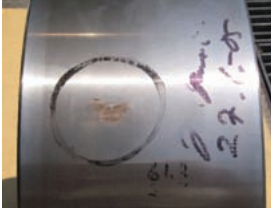
Failures	Characteristics	Damages		Causes	Countermeasures
(2) Cracking Chipping	 Inner ring of spherical roller bearing  Fractured section of inner ring	Axial crack occurs on bore surface of inner ring and raceway surface.		1) Excessive interference between inner ring and shaft 2) Great fit stress due to excessive difference in temperature of inner ring and that of shaft	1) Appropriate fit conditions of inner ring and shaft 2) Appropriate difference in temperature by checking load, rotation, and temperature conditions. (appropriate fit)
	 Inner ring bore surface of four-row tapered roller bearing	Circumferential crack occurs on bore surface and raceway surface of inner ring.		1) Step wear occurs on the shaft (roll neck), and the inner ring overrides the shaft, causing great bore surface stress	1) Provide circumferential groove for the roll neck. 2) When using a bearing with different chamfers for a roll, make the chamfers identical.
	 Outer ring raceway of double-row tapered roller bearing  Fractured section of outer ring	Axial crack occurs on outside surface and raceway surface of outer ring.		1) Excessive axial load 2) Axial clearance between the bearing and roll is great, and excessive axial load is applied.	1) Check for axial load. 2) Check the wear condition of counterpart components. 3) Reviewing thickness of the outer ring
	 Inner ring raceway of spherical thrust roller bearing  Assembly of tapered roller bearing	Crack occurs on inner ring back face rib.		1) Excessive axial load 2) Low holding shoulder diameter on the inner ring back face rib	1) Reviewing operating conditions 2) Reviewing dimensions of counterpart collar (Dimensions allowing backup of inner ring back face rib)

Table 7-1 (5) Bearing failures, causes and countermeasures

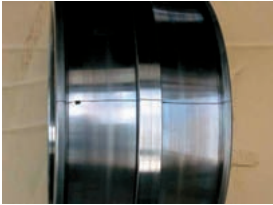

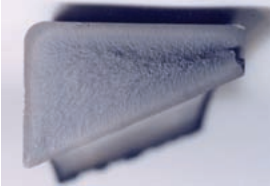

Failures	Characteristics	Damages		Causes	Countermeasures
(3) Brinelling Nicks	 <p>Outer ring raceway surface of four-row tapered roller bearing</p>  <p>Rolling contact surface of four-row cylindrical roller bearing</p>	1) Brinelling (Nicks) on raceway and rolling contact surfaces (scratch)  2) Brinelling on raceway surface at the same interval as rolling element spacing		1) Nicks occur on the raceway and rollers because of improper handling. · Mounting / dismounting bearing to / from chock · Replacing roll  2) Great bending load is applied to the roll neck. (Especially, when faulty rolling occurs)	1) Proper handling jig (use of a copper hammer) 2) Application of grease to raceway surface of inner and outer rings (Apply oil if the bearing is the oil lubricated type) 3) Prevention of impact load when replacing roll (Use of soft material) 4) Roll bending compared to bearing static load rating 5) Improvement in mounting method 6) Change in raceway chamfering 7) Check for excessive load on the slant chamfer of the raceway surface
(4) Scratch Scuffing	 <p>Roller end face of double-row cylindrical roller bearing</p>  <p>Outer ring rib of double-row cylindrical roller bearing</p>  <p>Roller large end face of double-row tapered roller bearing</p>	Scuffing on roller end face and rib of the raceway		1) Improper lubrication, ingress of foreign matters 2) Abnormal axial load caused by improper mounting or control of bearing overall thickness 3) Excessive axial load 4) Excessive preload	1) Selection of appropriate oil type and supply of adequate lubricant 2) Reviewing bearing mounting location 3) Reviewing bearing overall thickness control 4) Reviewing operating conditions 5) Checking preload



Table 7-1 (6) Bearing failures, causes and countermeasures







Failures	Characteristics	Damages		Causes	Countermeasures
(5) Smearing	<div style="display: flex; flex-wrap: wrap;"> <div style="width: 50%;">  <p>Outer ring raceway surface of four-row tapered roller bearing</p> </div> <div style="width: 50%;">  <p>Outer ring raceway surface of spherical roller bearing</p> </div> <div style="width: 50%;">  <p>Outer ring raceway surface of spherical roller bearing</p> </div> <div style="width: 50%;">  <p>Rolling element surface of spherical roller bearing</p> </div> </div>	Smearing on raceway or rolling contact surface		<ol style="list-style-type: none"> <li>1) Improper lubrication</li> <li>2) Slip of rolling elements (high speed, light load)</li> <li>3) Ingress of foreign matters during maintenance</li> </ol>	<ol style="list-style-type: none"> <li>1) Selection of appropriate oil type and supply of adequate lubricant</li> <li>2) Setup of appropriate preload</li> <li>3) Prevention of ingress of foreign matters</li> </ol>
(6) Corrosion Rust	<div style="display: flex; flex-wrap: wrap;"> <div style="width: 50%;"> <p>Corrosion</p>  <p>Outer ring of four-row tapered roller bearing</p> </div> <div style="width: 50%;">  <p>Outer ring of four-row tapered roller bearing</p> </div> <div style="width: 100%;"> <p>Rust</p>  <p>Outer ring of four-row tapered roller bearing</p> </div> </div>	<p>Rust, corrosion on the raceway surface at the same interval as rolling element spacing</p> <p>Rust on partial or entire surface of bearing</p>		<ol style="list-style-type: none"> <li>1) Worn or damaged seal lips</li> <li>2) Ingress of water or corrosive materials into clearance between roll neck and sleeve</li> </ol> <ol style="list-style-type: none"> <li>1) After the bearing was used, it has been left for a long period with moisture mixed in grease.</li> <li>2) Improper rust preventive treatment after the bearing was washed.</li> </ol>	<ol style="list-style-type: none"> <li>1) Improve seal maintenance and sealing method. Periodically check for wear or damage on the seal lips.</li> <li>2) Fit the "O" ring between the roll neck and the sleeve.</li> </ol> <ol style="list-style-type: none"> <li>1) Immediately after the bearing is removed from the chock, change grease.</li> <li>2) After washing the bearing, remove kerosene and water completely.</li> </ol>

Table 7-1 (7) Bearing failures, causes and countermeasures

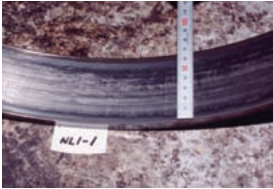
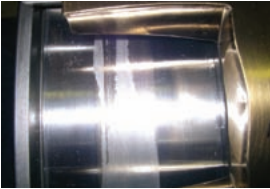







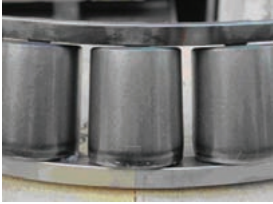

Failures	Characteristics	Damages		Causes	Countermeasures
(7) Creeping	 <p>Scuffing on rolling mill roll neck</p>  <p>Inner ring bore surface of four-row tapered roller bearing</p>	Wear, discoloration, and scuffing due to slip of fit surface		1) Insufficient grease or oil between the inner ring bore surface and the roll neck outside surface ( When creep occurs between the inner ring and the roll neck, because of loose fit of them. )	1) Provide the spiral groove for bore surface of inner ring 2) When mounting the bearing, apply grease with molybdenum disulfide or EP grease. (Apply oil if the bearing is the oil lubricated type)
(8) Seizure	 <p>Rolling contact surface of double-row tapered roller bearing</p>  <p>Roller large end face of double-row tapered roller bearing</p>  <p>Inner ring of double-row tapered roller bearing</p>	Discoloration, deformation, and melting caused by heat of bearing		1) Improper lubrication (insufficient or degraded lubricant) 2) Ingress of water due to faulty sealing 3) Excessive axial load 4) Heat generated by creep of inner ring 5) Ingress of dusts or foreign matters 6) Excessively small bearing internal clearance	1) Reviewing sealing type and conditions 2) Reviewing lubricating method and lubricant, and checking lubricated condition 3) Check for axial load 4) Reviewing bearing (type, size, etc.) 5) Reviewing clearance 6) Confirming operating conditions

Table 7-1 (8) Bearing failures, causes and countermeasures

Failures	Characteristics	Damages	Causes	Countermeasures
(9) Failure in lubrication	 <p>Inner ring assembly of four-row tapered roller bearing</p>	Grease including large quantity of water mixed in	1) Operated at high temperature ⇒ Grease is carbonized. 2) Ingress of water due to improper sealing or wear or damage of seal lip ( In this example, 20% or more of water is mixed in grease. )	1) Find the cause of high temperature. ( If the temperature cannot be lowered, review the possibility of change to high temperature grease. ) 2) Checking wear or damage of seal lip Find the cause of and countermeasure against the improper sealing.
	  <p>Inner ring assembly of double-row tapered roller bearing      Outer ring of double-row tapered roller bearing</p>	Foreign matter attachment and corrosion occur because of ingress of a great deal of foreign matters (scale and water for rolling).	1) Ingress of water due to improper sealing or wear or damage of seal lip	1) Checking wear or damage of seal lip Find the cause of and countermeasure against the improper sealing.
	 <p>Four-row tapered roller bearing</p>	Seizure and adhesion of raceway, roller, and cage	1) Varied factors including improper lubrication, improper operation, and ingress of foreign matters occur, causing damages.	1) Checking improper operation 2) Checking lubricating conditions 3) Checking degradation of peripheral parts
	  <p>Outer ring assembly of four-row cylindrical roller bearing      Outer ring assembly of four-row cylindrical roller bearing</p>	Looseness and breaking of pin	1) Abnormal load due to vibration occurs. 2) End of cage's service life because of use for a long period	1) Checking abnormal vibration 2) Replace if it has been used for a long period.

# **Bearing specification tables**

# Deep groove ball bearings

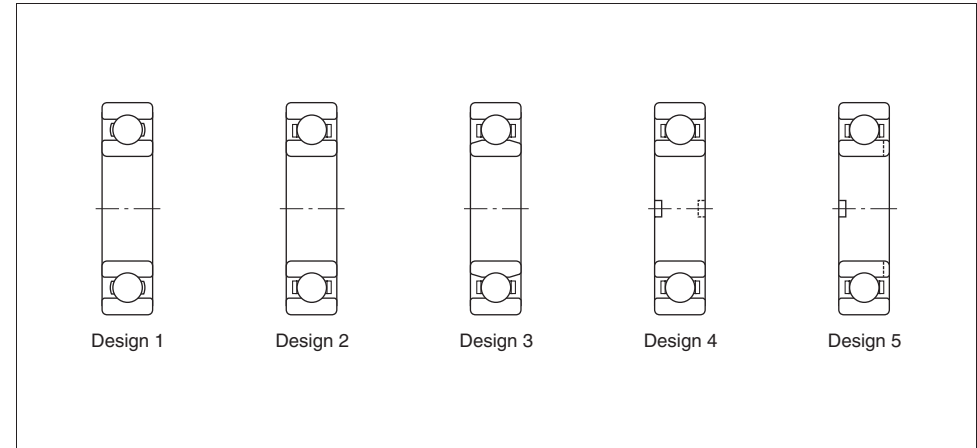

- Deep groove ball bearings can accommodate radial load and axial load in both directions.
- Suitable for operation at high speed, with low vibration.



<b>Boundary dimensions</b>	The dimensions of standard series are as specified in JIS B 1512.						
<b>Tolerances</b>	As specified in JIS B 1514, class 0 or 6 (refer to Table 2-2 on page 14.)						
<b>Allowable misalignment</b>	0.002 3 rad (8') – 0.003 4 rad (12')						
<b>Radial internal clearance</b>	(refer to Table 4-2 on page 46)						
<b>Standard cages</b>	Pressed cage (design 1) or machined cage (design 2 to 5).						
<b>Equivalent radial load</b>	<b>Dynamic equivalent radial load</b> $P_r = XF_r + YF_a$	$\frac{f_0 F_a}{C_{0r}}$	$e$	$\frac{F_a}{F_r} \leq e$		$\frac{F_a}{F_r} > e$	
	<b>Static equivalent radial load</b> $P_{0r} = 0.6F_r + 0.5F_a$ (when the value of $P_{0r} < F_r, P_{0r} = F_r$ )			$X$	$Y$	$X$	$Y$
		0.172	0.19				2.30
		0.345	0.22				1.99
		0.689	0.26				1.71
		1.03	0.28	1	0	0.56	1.55
		1.38	0.30				1.45
		2.07	0.34				1.31
		3.45	0.38				1.15
		5.17	0.42				1.04
		6.89	0.44				1.00

Factor  $f_0$  is shown in the bearing specification table.

# Single-row deep groove ball bearings

*d* 100 ~ 130 mm

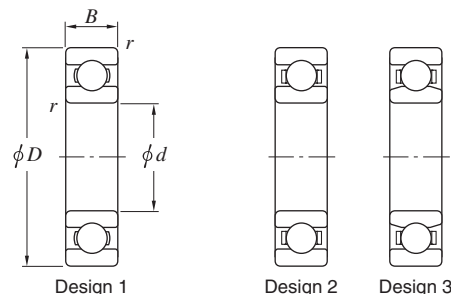

*d* 140 ~ (180) mm

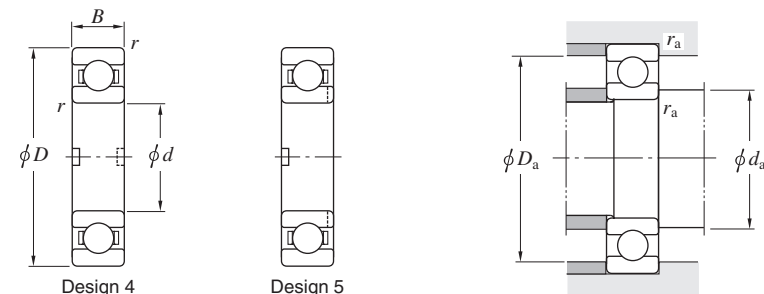

Boundary dimensions (mm)				Basic load ratings (kN)		Factor	Bearing No.	Design	Mounting dimensions (mm)			(Refer.) Mass (kg)
<i>d</i>	<i>D</i>	<i>B</i>	<i>r</i> min.	<i>C<sub>r</sub></i>	<i>C<sub>0r</sub></i>	<i>f<sub>0</sub></i>			<i>d<sub>a</sub></i> min.	<i>D<sub>a</sub></i> max.	<i>r<sub>a</sub></i> max.	
<b>100</b>	125	13	1	19.6	21.2	16.0	<b>6820</b>	1	105	120	1	0.309
	140	20	1.1	45.0	41.9	16.2	<b>6920</b>	2	106.5	133.5	1	0.960
	150	16	1	42.4	42.1	16.5	<b>16020</b>	1	105	145	1	0.910
	150	24	1.5	60.2	54.2	15.9	<b>6020</b>	1	108	142	1.5	1.25
	180	34	2.1	122	93.1	14.4	<b>6220</b>	1	111	169	2	3.14
	215	47	3	173	141	13.2	<b>6320</b>	1	113	202	2.5	7.00
<b>105</b>	145	20	1.1	46.5	44.8	16.4	<b>6921</b>	2	111.5	138.5	1	1.00
	160	18	1	41.9	42.2	16.5	<b>16021</b>	1	110	155	1	1.20
	160	26	2	72.3	65.8	15.8	<b>6021</b>	1	114	151	2	1.59
	190	36	2.1	133	105	14.4	<b>6221</b>	1	116	179	2	3.70
	225	49	3	184	153	13.2	<b>6321</b>	1	118	212	2.5	8.05
	<b>110</b>	140	16	1	28.1	30.7	16.1	<b>6822</b>	1	115	135	1
150		20	1.1	47.9	47.8	16.4	<b>6922</b>	2	116.5	143.5	1	1.04
170		19	1	57.5	56.7	16.3	<b>16022</b>	1	115	165	1	1.46
170		28	2	82.0	73.0	15.6	<b>6022</b>	1	119	161	2	1.96
200		38	2.1	144	117	14.4	<b>6222</b>	1	121	189	2	4.36
240		50	3	205	180	13.2	<b>6322</b>	1	123	227	2.5	9.54
<b>120</b>	150	16	1	29.0	33.0	16.0	<b>6824</b>	1	125	145	1	0.655
	165	22	1.1	57.2	56.9	16.4	<b>6924</b>	2	126.5	158.5	1	1.41
	180	19	1	63.2	63.3	16.4	<b>16024</b>	1	125	175	1	1.80
	180	28	2	85.0	79.3	15.9	<b>6024</b>	1	129	171	2	2.07
	215	40	2.1	155	131	14.4	<b>6224</b>	1	131	204	2	5.15
	260	55	3	207	185	13.5	<b>6324</b>	1	133	247	2.5	12.5
<b>130</b>	165	18	1.1	36.9	41.2	16.1	<b>6826</b>	1	136.5	158.5	1	0.939
	180	24	1.5	65.2	67.4	16.3	<b>6926</b>	2	138	172	1.5	1.86
	200	22	1.1	71.3	74.8	11.2	<b>16026</b>	1	136.5	193.5	1	2.69
	200	33	2	106	101	15.8	<b>6026</b>	1	139	191	2	3.16
	230	40	3	167	146	14.5	<b>6226</b>	1	143	217	2.5	5.82
	280	58	4	229	214	13.6	<b>6326</b>	1	146	264	3	15.1

Boundary dimensions (mm)				Basic load ratings (kN)		Factor	Bearing No.	Design	Mounting dimensions (mm)			(Refer.) Mass (kg)
<i>d</i>	<i>D</i>	<i>B</i>	<i>r</i> min.	<i>C<sub>r</sub></i>	<i>C<sub>0r</sub></i>	<i>f<sub>0</sub></i>			<i>d<sub>a</sub></i> min.	<i>D<sub>a</sub></i> max.	<i>r<sub>a</sub></i> max.	
<b>140</b>	175	18	1.1	38.2	44.4	16.0	<b>6828</b>	1	146.5	168.5	1	1.00
	190	24	1.5	71.3	74.8	16.5	<b>6928</b>	2	148	182	1.5	1.98
	210	22	1.1	65.8	71.1	16.5	<b>16028</b>	1	146.5	203.5	1	2.86
	210	33	2	110	109	15.9	<b>6028</b>	1	149	201	2	3.55
	250	42	3	166	150	14.8	<b>6228</b>	1	153	237	2.5	7.45
	300	62	4	253	246	13.6	<b>6328</b>	1	156	284	3	19.4
<b>150</b>	190	20	1.1	47.8	54.9	16.1	<b>6830</b>	1	156.5	183.5	1	1.40
	210	28	2	93.4	94.3	16.2	<b>6930</b>	2	159	201	2	3.05
	225	24	1.1	91.2	99.3	16.6	<b>16030</b>	2	156.5	218.5	1	3.58
	225	35	2.1	125	126	16.0	<b>6030</b>	1	161	214	2	4.22
	230	35	2.1	125	116	15.8	<b>306891A</b>	2	161	219	2	5.50
	270	45	3	176	168	15.1	<b>6230</b>	1	163	257	2.5	9.41
320	65	4	275	284	13.9	<b>6330</b>	2	166	304	3	26.2	
<b>160</b>	200	20	1.1	48.4	56.9	16.1	<b>6832</b>	1	166.5	193.5	1	1.45
	220	28	2	96.1	101	16.4	<b>6932</b>	2	169	211	2	3.20
	229.5	33	2	99	108	16.5	<b>SB322333A</b>	2	169	220.5	2	4.2
	240	25	1.5	98.8	108	16.5	<b>16032</b>	2	168	232	1.5	4.25
	240	38	2.1	136	135	15.9	<b>6032</b>	1	171	229	2	5.22
	290	48	3	185	186	15.4	<b>6232</b>	2	173	277	2.5	14.3
340	68	4	278	286	13.9	<b>6332</b>	2	176	324	3	29.0	
<b>170</b>	215	22	1.1	59.8	70.5	16.1	<b>6834</b>	1	176.5	208.5	1	1.90
	230	28	2	98.8	108	16.5	<b>6934</b>	2	179	221	2	3.35
	249.5	38	2	135	137	16.1	<b>SB342538</b>	2	179	240.5	2	6.00
	260	28	1.5	114	127	16.5	<b>16034</b>	2	178	252	1.5	5.75
	260	42	2.1	161	161	15.8	<b>6034</b>	1	181	249	2	6.80
	310	52	4	212	223	15.3	<b>6234</b>	2	186	294	3	17.5
360	72	4	326	355	13.6	<b>6334</b>	2	186	344	3	38.6	
<b>180</b>	225	22	1.1	60.7	73.1	16.1	<b>6836</b>	1	186.5	218.5	1	2.00

# Single-row deep groove ball bearings

$d$  (180) ~ (220) mm

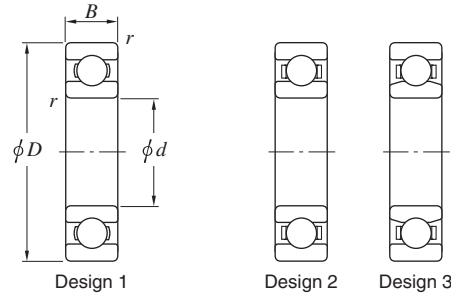

$d$  (220) ~ (280) mm

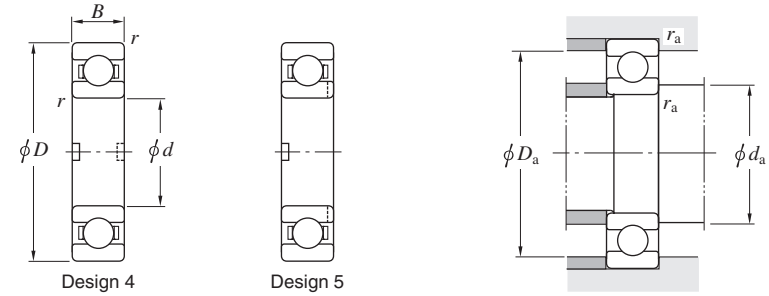

Boundary dimensions (mm)				Basic load ratings (kN)		Factor	Bearing No.	Design	Mounting dimensions (mm)			(Refer.) Mass (kg)
$d$	$D$	$B$	$r_{min.}$	$C_r$	$C_{0r}$	$f_0$			$d_a$ min.	$D_a$ max.	$r_a$ max.	
<b>180</b>	250	33	2	123	129	16.3	<b>6936</b>	2	189	241	2	4.90
	259.5	33	2	114	127	16.5	<b>306840</b>	2	189	250.5	2	6.10
	265	33	2	140	147	16.2	<b>SB3627</b>	2	189	256	2	6.20
	280	31	2	135	148	16.4	<b>16036</b>	2	189	271	2	7.55
	280	46	2.1	182	194	15.8	<b>6036</b>	2	191	269	2	10.3
	320	52	4	227	241	15.1	<b>6236</b>	2	196	304	3	18.3
	380	75	4	354	407	13.9	<b>6336</b>	2	196	364	3	44.7
<b>190</b>	240	24	1.5	73.1	88.1	16.1	<b>6838</b>	1	198	232	1.5	2.60
	259.5	33	2	113	127	16.6	<b>SB382633</b>	2	199	250.5	2	5.10
	260	33	2	126	138	16.4	<b>6938</b>	2	199	251	2	5.20
	269.5	33	2	139	148	16.3	<b>306627A</b>	2	199	260.5	2	6.50
	290	31	2	139	158	16.6	<b>16038</b>	2	199	281	2	7.85
	290	46	2.1	188	201	15.8	<b>6038</b>	2	201	279	2	10.8
	340	55	4	255	281	15.0	<b>6238</b>	2	206	324	3	23.0
	400	78	5	355	415	14.1	<b>6338</b>	2	210	380	4	51.5
<b>200</b>	250	24	1.5	78.0	93.6	16.1	<b>6840</b>	2	208	242	1.5	2.70
	279.5	38	2.1	143	158	16.4	<b>360278</b>	2	211	268.5	2	7.40
	280	38	2.1	157	168	16.2	<b>6940</b>	2	211	269	2	7.30
	289.5	38	2.1	165	176	16.1	<b>306841</b>	2	211	278.5	2	8.90
	310	34	2	161	180	16.4	<b>16040</b>	2	209	301	2	10.1
	310	51	2.1	217	243	15.6	<b>6040</b>	2	211	299	2	14.0
	360	58	4	269	311	15.2	<b>6240</b>	2	216	344	3	28.2
	420	80	5	411	506	14.0	<b>6340</b>	2	220	400	4	58.0
	<b>210</b>	299.5	38	2.1	170	189	16.2	<b>SB4230</b>	2	221	288.5	2
<b>220</b>	270	24	1.5	80.7	101	16.0	<b>6844</b>	2	228	262	1.5	3.00
	300	38	2.1	160	180	16.4	<b>6944</b>	2	231	289	2	7.90
	309.5	38	2.1	151	178	16.5	<b>306867</b>	2	231	298.5	2	9.40
	319.5	46	2.1	193	220	16.1	<b>SB4432A</b>	2	231	308.5	2	11.9

Boundary dimensions (mm)				Basic load ratings (kN)		Factor	Bearing No.	Design	Mounting dimensions (mm)			(Refer.) Mass (kg)
$d$	$D$	$B$	$r_{min.}$	$C_r$	$C_{0r}$	$f_0$			$d_a$ min.	$D_a$ max.	$r_a$ max.	
<b>220</b>	340	37	2.1	180	217	16.5	<b>16044</b>	2	231	329	2	13.2
	340	56	3	235	271	15.6	<b>6044</b>	2	233	327	2.5	18.3
	400	65	4	311	376	15.1	<b>6244</b>	2	236	384	3	37.0
	460	88	5	433	539	13.8	<b>6344</b>	2	240	440	4	71.6
<b>230</b>	329.5	40	2.1	183	213	16.3	<b>306842A</b>	2	241	318.5	2	11.9
	339.5	45	3	223	267	16	<b>SB4634</b>	2	243	326.5	2.5	13.6
<b>240</b>	300	28	2	108	135	16.1	<b>6848</b>	2	249	291	2	4.50
	320	38	2.1	164	192	16.5	<b>6948</b>	2	251	309	2	8.50
	329.5	40	2.1	173	205	16.5	<b>SB4833</b>	2	251	318.5	2	9.80
	360	37	2.1	184	228	16.5	<b>16048</b>	2	251	349	2	14.1
	360	56	3	244	296	15.9	<b>6048</b>	2	253	347	2.5	19.7
	440	72	4	340	431	15.2	<b>6248</b>	2	256	424	3	51.0
<b>250</b>	340	42	2.1	168	202	16.5	<b>SB5034A</b>	2	261	329	2	10.8
	349.5	46	2.1	197	238	16.4	<b>SB5035</b>	2	261	338.5	2	13.1
<b>260</b>	320	28	2	112	146	16.0	<b>6852</b>	2	269	311	2	4.80
	360	46	2.1	213	263	16.3	<b>6952</b>	2	271	349	2	14.4
	369.5	46	2.1	229	289	16.2	<b>306862</b>	2	271	358.5	2	16.0
	379.5	56	3	253	321	16.1	<b>SB5238</b>	2	273	366.5	2.5	20.3
	400	44	3	236	310	16.4	<b>16052</b>	2	273	387	2.5	21.6
	400	65	4	291	377	15.8	<b>6052</b>	2	276	384	3	29.3
<b>270</b>	480	80	5	402	541	15.1	<b>6252</b>	2	280	460	4	68.2
	<b>270</b>	379.5	46	2.1	228	290	16.3	<b>SB5438</b>	2	281	368.5	2
<b>280</b>	350	33	2	143	183	16.1	<b>6856</b>	2	289	341	2	7.40
	380	46	2.1	219	283	16.5	<b>6956</b>	2	291	369	2	15.1
	389.5	46	2.1	236	310	16.4	<b>306861A</b>	2	291	378.5	2	18.0
	420	44	3	242	331	14.7	<b>16056</b>	2	293	407	2.5	22.9

# Single-row deep groove ball bearings

$d$  (280) ~ 340 mm

$d$  360 ~ (460) mm

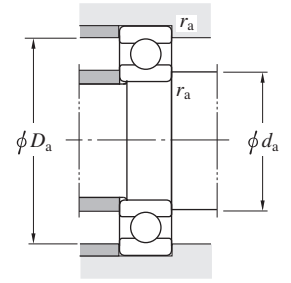
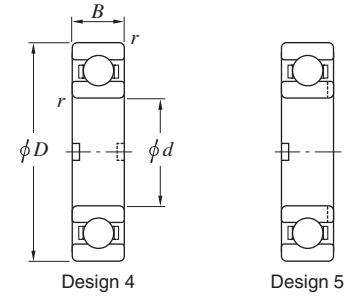
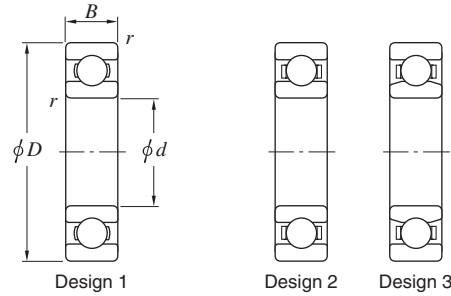

Boundary dimensions (mm)				Basic load ratings (kN)		Factor	Bearing No.	Design	Mounting dimensions (mm)			(Refer.)
$d$	$D$	$B$	$r_{min.}$	$C_r$	$C_{Or}$	$f_0$			$d_a$ min.	$D_a$ max.	$r_a$ max.	Mass (kg)
<b>280</b>	420	65	4	302	408	16.0	<b>6056</b>	2	296	404	3	31.0
	500	80	5	423	599	15.3	<b>6256</b>	2	300	480	4	71.8
<b>290</b>	400	52	4	234	311	16.5	<b>SB5840</b>	2	306	384	3	19.6
	409.5	56	3	260	347	16.3	<b>SB5841</b>	2	303	396.5	2.5	22.2
	419.5	60	4	297	377	16.2	<b>SB584260</b>	2	306	403.5	3	26.5
<b>300</b>	380	38	2.1	179	230	16.2	<b>6860</b>	2	311	369	2	10.5
	419.5	56	3	258	349	16.4	<b>SB604256</b>	2	313	406.5	2.5	22.9
	420	56	3	276	377	16.2	<b>6960</b>	2	313	407	2.5	24.1
	429.5	56	3	257	350	16.4	<b>SB6043</b>	2	313	416.5	2.5	26.7
	460	50	4	284	405	16.4	<b>16060</b>	2	316	447	3	32.2
	460	74	4	355	482	15.6	<b>6060</b>	2	316	444	3	44.0
<b>310</b>	429.5	60	4	275	379	16.3	<b>SB624360</b>	2	326	413.5	3	25.3
<b>320</b>	400	38	2.1	182	239	16.1	<b>6864</b>	2	331	389	2	11.0
	440	56	3	285	404	16.4	<b>6964</b>	2	333	427	2.5	25.5
	449.5	56	3	291	411	16.3	<b>SB6445A</b>	2	333	436.5	2.5	26.4
	480	50	4	292	432	16.5	<b>16064</b>	2	336	467	3	33.9
480	74	4	352	487	15.7	<b>6064</b>	2	336	464	3	46.0	
<b>330</b>	459.5	56	3	301	439	16.4	<b>SB6646</b>	2	343	446.5	2.5	28.4
<b>340</b>	420	38	2.1	185	249	16.1	<b>6868</b>	2	351	409	2	11.5
	449.5	56	3	282	407	16.5	<b>SB684556</b>	2	353	436.5	2.5	22.9
	460	56	3	282	407	16.5	<b>6968</b>	2	353	447	2.5	26.8
	479.5	65	3	330	480	16.2	<b>SB6848</b>	2	353	466.5	2.5	35.5
	489.5	60	5	329	481	16.2	<b>SB6849</b>	2	360	469.5	4	36.4
	520	57	4	335	512	16.4	<b>16068</b>	2	356	507	3	46.8
	520	82	5	441	661	15.6	<b>6068</b>	2	360	500	4	61.8
	540	90	5	462	679	15.4	<b>SB6854</b>	2	360	520	4	77.2
	620	92	6	511	817	15.6	<b>6268</b>	2	364	596	5	131
	710	118	7.5	704	1160	14.7	<b>6368</b>	2	372	678	6	238

Boundary dimensions (mm)				Basic load ratings (kN)		Factor	Bearing No.	Design	Mounting dimensions (mm)			(Refer.)
$d$	$D$	$B$	$r_{min.}$	$C_r$	$C_{Or}$	$f_0$			$d_a$ min.	$D_a$ max.	$r_a$ max.	Mass (kg)
<b>360</b>	440	38	2.1	192	268	16.0	<b>6872</b>	2	371	429	2	12.0
	480	56	3	289	432	16.5	<b>6972</b>	2	373	467	2.5	28.2
	509.5	70	5	364	550	16.2	<b>SB725170</b>	2	380	489	4	42.7
	540	57	4	345	546	16.5	<b>16072</b>	2	376	527	3	49.0
	540	82	5	438	668	15.7	<b>6072</b>	2	380	520	4	64.7
550	85	5	438	669	15.8	<b>SB7255</b>	2	380	530	4	71.9	
<b>380</b>	480	46	2.1	244	359	16.2	<b>6876</b>	2	391	469	2	20.0
	520	65	4	352	552	16.4	<b>6976</b>	2	396	504	3	40.8
	560	82	5	457	725	15.9	<b>6076</b>	2	400	540	4	67.6
<b>400</b>	500	46	2.1	249	374	16.1	<b>6880</b>	2	411	489	2	20.5
	540	65	4	362	588	16.5	<b>6980</b>	2	416	524	3	42.7
	600	63	5	358	587	16.5	<b>16080</b>	2	420	580	4	65.0
	600	90	5	508	824	15.7	<b>6080</b>	2	420	580	4	87.7
	720	130	6	628	1080	15.5	<b>SB8072A</b>	4	424	696	5	232
<b>420</b>	520	46	2.1	253	389	16.1	<b>6884</b>	2	431	509	2	21.5
	560	65	4	359	588	16.5	<b>6984</b>	2	436	544	3	43.5
	620	90	5	530	894	15.8	<b>6084</b>	2	440	600	4	91.2
<b>430</b>	600	75	4	408	678	16.4	<b>SB8660</b>	2	446	584	3	64.6
<b>440</b>	540	46	2.1	257	404	16.0	<b>6888</b>	2	451	529	2	22.5
	600	74	4	396	676	16.4	<b>6988</b>	2	456	584	3	61.3
	619	75	4	422	724	16.5	<b>SB8862A</b>	2	456	603	3	70.3
	650	67	5	407	710	16.5	<b>16088</b>	2	460	630	4	81.7
	650	94	6	526	902	16	<b>6088</b>	2	464	626	5	105
<b>450</b>	630	75	4	407	711	16.5	<b>SB9063</b>	2	466	614	3	72
<b>460</b>	580	56	3	314	517	16.2	<b>6892</b>	2	473	567	2.5	35.0
	620	74	4	407	711	16.5	<b>6992</b>	2	476	604	3	61.7
	659	80	4	484	854	16.3	<b>SB9266</b>	2	476	643	3	90



# Single-row deep groove ball bearings

$d$  (460) ~ (670) mm

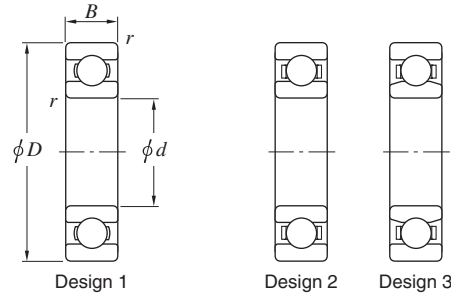

$d$  (670) ~ 1 000 mm

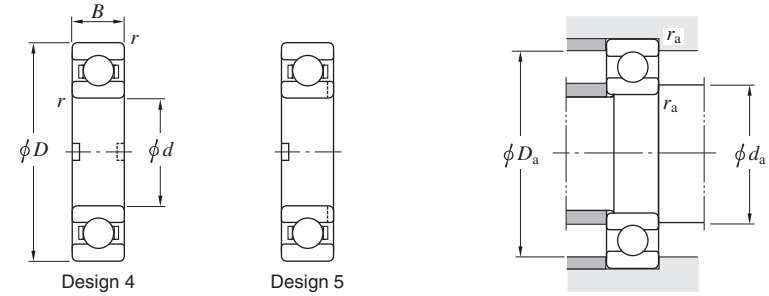

Boundary dimensions (mm)				Basic load ratings (kN)		Factor	Bearing No.	Design	Mounting dimensions (mm)			(Refer.) Mass (kg)
$d$	$D$	$B$	$r_{min.}$	$C_r$	$C_{0r}$	$f_0$			$d_a$ min.	$D_a$ max.	$r_a$ max.	
460	680	71	5	431	767	16.5	16092	2	480	660	4	91.2
	680	100	6	577	1 000	15.8	6092	2	484	656	5	124
480	600	56	3	321	539	16.1	6896	2	493	587	2.5	36.5
	700	100	6	603	1 090	15.9	6096	2	504	676	5	127
500	620	56	3	327	561	16.1	68/500	2	513	607	2.5	37.5
	670	78	5	444	807	16.5	69/500	2	520	650	4	75.2
	720	100	6	600	1 100	16.0	60/500	2	524	696	5	128
520	679.5	78	3	457	848	16.4	SB520-1	2	533	666.5	2.5	72.2
530	650	56	3	331	581	16.0	68/530	2	543	637	2.5	39.5
	710	82	5	512	975	16.6	69/530	2	550	690	4	89.2
	760	100	6	621	1 180	16.2	SB530	2	554	736	5	144
560	680	56	3	335	602	16.0	68/560	2	573	667	2.5	42.0
	820	115	6	763	1 520	15.9	60/560	2	584	796	5	199
570	799	115	6	641	1 280	16.3	SB570	2	594	775	5	172
590	820	105	6	637	1 280	16.4	SB590A	2	614	796	5	166
600	730	60	3	377	707	16.0	68/600	2	613	717	2.5	52.0
	800	90	5	592	1 200	16.4	69/600	2	620	780	4	127
610	720	55	3	303	559	15.7	SB610D	2	623	707	2.5	38.8
	730	54	3	302	559	15.7	SB610A	3	623	717	2.5	42.3
	849.5	100	6	659	1 370	16.5	SB610C	2	634	825.5	5	172
	869	120	5	725	1 520	16.3	SB610B	5	630	849	4	221
630	780	69	4	446	875	16.1	68/630	2	646	767	3	69.0
	920	128	7.5	841	1 770	16.0	60/630	2	662	888	6	276
670	820	69	4	452	908	16.0	68/670	2	686	807	3	76.9

Boundary dimensions (mm)				Basic load ratings (kN)		Factor	Bearing No.	Design	Mounting dimensions (mm)			(Refer.) Mass (kg)
$d$	$D$	$B$	$r_{min.}$	$C_r$	$C_{0r}$	$f_0$			$d_a$ min.	$D_a$ max.	$r_a$ max.	
670	980	136	7.5	870	1 920	16.2	60/670	2	702	948	6	337
700	979	150	6	837	1 900	16.4	SB700	5	724	955	5	326
710	870	74	4	495	1 030	16.0	68/710	2	726	854	3	93.8
	1 030	140	7.5	1 020	2 310	16.0	60/710	2	742	998	6	394
	1 080	160	7.5	1 060	2 490	16.1	SB710	2	742	1 048	6	524
730	900	78	5	476	1 010	15.9	SB730	3	750	880	4	105
750	920	78	5	514	1 110	15.9	68/750	2	770	900	4	111
	1 090	150	7.5	1 050	2 500	16.1	60/750	2	782	1 058	6	473
800	980	82	5	584	1 310	16.0	68/800	2	820	960	4	127
	1 150	155	7.5	1 090	2 690	16.3	60/800	2	832	1 118	6	533
830	1 080	115	6	795	1 900	16.3	SB830	4	854	1 056	5	275
850	1 030	82	5	591	1 350	15.9	68/850	2	870	1 010	4	135
	1 120	118	6	903	2 240	16.4	69/850	2	874	1 096	5	315
	1 178	160	7.5	1 080	2 710	16.4	SB850A	2	882	1 146	6	524
880	1 130	115	6	811	1 980	16.2	SB880	2	904	1 106	5	265
900	1 090	85	5	611	1 450	15.9	68/900	2	920	1 070	4	162
	1 180	122	6	888	2 220	16.3	69/900	2	924	1 156	5	347
920	1 180	120	6	828	1 020	16.2	SB920	2	944	1 156	5	320
930	1 010	40	2.1	218	494	14.3	SB930A	2	946	994	2	31
950	1 150	90	5	701	1 740	15.9	68/950	2	970	1 130	4	190
	1 250	132	7.5	989	2 580	16.3	69/950	2	982	1 218	6	431
1 000	1 220	100	6	790	2 030	16.0	68/1000	2	1 024	1 196	5	245
	1 380	190	7.5	1 170	3 220	16.4	SB1000	2	1 032	1 348	6	837

# Single-row deep groove ball bearings

$d$  1 060 ~ 1 420 mm

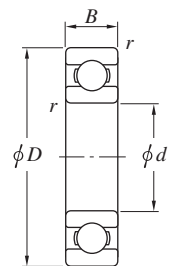

Design 1



Design 2



Design 3

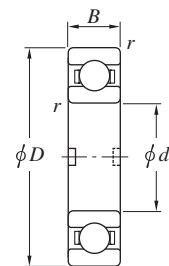

Design 4

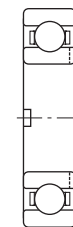

Design 5

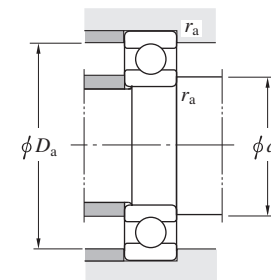

Boundary dimensions (mm)				Basic load ratings (kN)		Factor	Bearing No.	Design	Mounting dimensions (mm)			(Refer.) Mass (kg)
$d$	$D$	$B$	$r_{min.}$	$C_r$	$C_{0r}$	$f_0$			$d_a$ min.	$D_a$ max.	$r_a$ max.	
1 060	1 280	100	6	798	2 100	15.9	<b>68/1060</b>	2	1 084	1 256	5	251
1 090	1 350	122	7.5	890	2 140	16	<b>SB1090</b>	2	1 122	1 318	6	376
1 100	1 200	50	2.1	316	744	14.2	<b>SB1100A</b>	2	1 116	1 184	2	56
1 120	1 360	106	6	886	2 410	15.6	<b>68/1120</b>	2	1 144	1 336	5	319
1 200	1 450	112	7.5	915	2 580	15.8	<b>SB1200</b>	2	1 232	1 418	6	363
1 240	1 510	122	7.5	1 010	2 930	15.9	<b>SB1240</b>	2	1 272	1 478	6	446
1 320	1 600	122	6	1 040	3 130	15.9	<b>68/1320</b>	2	1 344	1 576	5	504
1 400	1 700	132	7.5	1 130	3 510	15.8	<b>68/1400</b>	2	1 432	1 668	6	621
1 420	1 800	150	9.5	1 150	3 630	15.8	<b>SB1400B</b>	2	1 460	1 760	8	915

# Angular contact ball bearings



■ Single-row, matched pair (page 100)

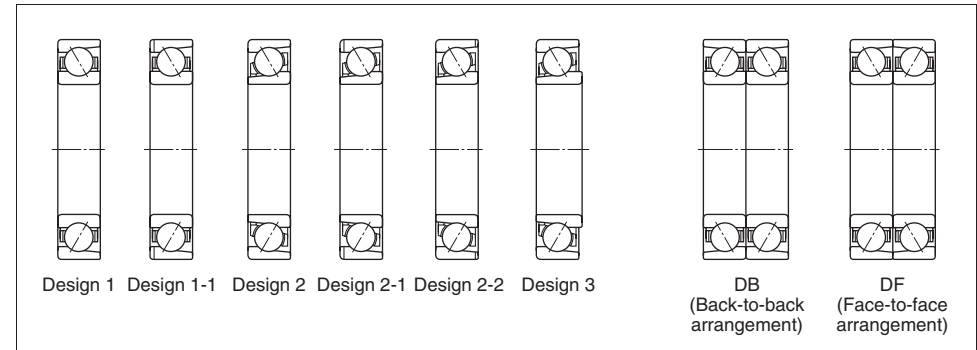

■ Double-row (page 112)

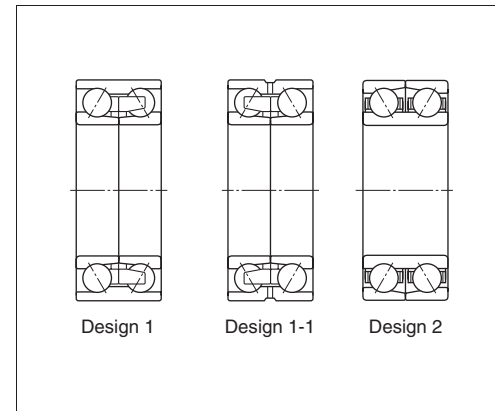

- Single-row bearings can accommodate radial load and axial load in one direction.
- DB and DF matched pair bearings and double-row bearings can accommodate radial load and axial load in both directions.
- Two or more single-row angular contact ball bearings are often combined in order to increase the load rating or rigidity. In this case, two types of arrangements, back-to-back arrangement (DB) and face-to-face arrangement (DF), are available. If the load rating of a single-row angular contact ball bearing is insufficient, use the tandem arrangement (DT).

<b>Boundary dimensions</b>	The dimensions of standard series are as specified in JIS B 1512-1995.
<b>Tolerances</b>	As specified in JIS B 1514, class 0 or 6. (refer to Table 2-2 on page 14.)
<b>Contact angle (<math>\alpha</math>)</b>	The standard contact angles are 15°, 30° and 40°. Bearings with a smaller contact angle are more suitable for applications involving high-speed rotation. Those with a larger contact angle feature superior axial load resistance. (The standard contact angles of single-row and matched pair angular contact ball bearings) 15°.....supplementary code C 30°.....supplementary code A or no indication 40°.....supplementary code B [Note] Contact angles of double-row angular contact ball bearings are shown in specification tables.
<b>Allowable misalignment</b>	Single-row.....0.000 6 rad (2') : Matched pair, double-row.....misalignment not allowed
<b>Internal clearance</b>	(refer to Table 4-3 on pages 46, 47)
<b>Standard cages</b>	Machined cage

Equiv- alent radial load	Single- row and matched pair angular contact ball bearings	Dynamic equivalent radial load $P_r = XF_r + YF_a$	Contact angle	$\frac{if_0F_a}{C_{0r}}$	$e$	Single-row and tandem (DT) arrangement			Back-to-back (DB) and face-to-face (DF) arrangement								
						$\frac{F_a}{F_r} \leq e$			$\frac{F_a}{F_r} > e$			$\frac{F_a}{F_r} \leq e$			$\frac{F_a}{F_r} > e$		
						X	Y	Y	X	Y	Y	X	Y	Y	X	Y	
			$\alpha = 15^\circ$	0.178	0.38				1.47			1.65		2.39			
				0.357	0.40				1.40			1.57		2.28			
				0.714	0.43				1.30			1.46		2.11			
				1.07	0.46	1	0	0.44	1.23	1	0.72	1.38		2.00			
				1.43	0.47				1.19			1.34		1.93			
				2.14	0.50				1.12			1.26		1.82			
				3.57	0.55				1.02			1.14		1.66			
			5.35	0.56				1.00			1.12		1.63				
			$\alpha = 30^\circ$	-	0.80	1	0	0.39	0.76	1	0.78	0.63	1.24				
			$\alpha = 40^\circ$	-	1.14	1	0	0.35	0.57	1	0.55	0.57	0.93				

For  $i$ , use 2 for DB & DF and 1 for single & DT.  
Factor  $f_0$  is shown in the bearing specification table.

Contact angle	Single-row and tandem (DT) arrangement		Back-to-back (DB) and face-to-face (DF) arrangement	
	$X_0$	$Y_0$	$X_0$	$Y_0$
$\alpha = 15^\circ$	0.5	0.46	1	0.92
$\alpha = 30^\circ$	0.5	0.33	1	0.66
$\alpha = 40^\circ$	0.5	0.26	1	0.52

Static equivalent radial load  
 $P_{0r} = X_0F_r + Y_0F_a$   
(In reference to single-row and tandem arrangement bearings, when  $P_{0r} < F_r$   
 $P_{0r} = F_r$ )

Contact angle	$e$	$\frac{F_a}{F_r} \leq e$		$\frac{F_a}{F_r} > e$	
		X	Y	X	Y
$\alpha = 30^\circ$	0.80	1	0.78	0.63	1.24
$\alpha = 32^\circ$	0.86	1	0.73	0.62	1.17

Contact angle	$X_0$	$Y_0$
$\alpha = 30^\circ$	1	0.66
$\alpha = 32^\circ$	1	0.63

Static equivalent radial load  
 $P_{0r} = X_0F_r + Y_0F_a$

Dynamic equivalent load calculation : when a pair of single-row angular contact ball bearings is arranged face-to-face or back-to-back.

While radial loads  $F_{rA}$  and  $F_{rB}$  are applied to bearings A and B, axial load  $K_a$  externally acts in the directions shown in the figures below.

[Remark]

When radial load is applied to a single-row angular contact ball bearing, axial load generated as an axial component of force acts on another bearing. The axial load can be obtained by the following equation.

$$F_a = \frac{F_r}{2Y}$$

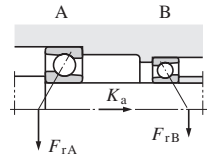
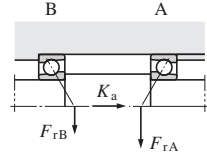
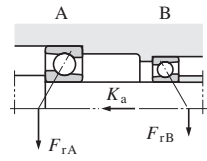
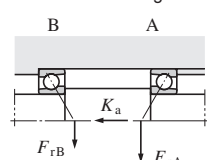
Paired mounting	Loading condition	Bearing	Axial load	Dynamic equivalent load
Back-to-back arrangement 	$\frac{F_{rB}}{2Y_B} + K_a \geq \frac{F_{rA}}{2Y_A}$	Bearing A	$\frac{F_{rB}}{2Y_B} + K_a$	$P_A = XF_{rA} + Y_A \left( \frac{F_{rB}}{2Y_B} + K_a \right)$ $P_A = F_{rA}$ , where $P_A < F_{rA}$
		Bearing B	-	$P_B = F_{rB}$
Face-to-face arrangement 	$\frac{F_{rB}}{2Y_B} + K_a < \frac{F_{rA}}{2Y_A}$	Bearing A	-	$P_A = F_{rA}$
		Bearing B	$\frac{F_{rA}}{2Y_A} - K_a$	$P_B = XF_{rB} + Y_B \left( \frac{F_{rA}}{2Y_A} - K_a \right)$ $P_B = F_{rB}$ , where $P_B < F_{rB}$
Back-to-back arrangement 	$\frac{F_{rB}}{2Y_B} \leq \frac{F_{rA}}{2Y_A} + K_a$	Bearing A	-	$P_A = F_{rA}$
		Bearing B	$\frac{F_{rA}}{2Y_A} + K_a$	$P_B = XF_{rB} + Y_B \left( \frac{F_{rA}}{2Y_A} + K_a \right)$ $P_B = F_{rB}$ , where $P_B < F_{rB}$
Face-to-face arrangement 	$\frac{F_{rB}}{2Y_B} > \frac{F_{rA}}{2Y_A} + K_a$	Bearing A	$\frac{F_{rB}}{2Y_B} - K_a$	$P_A = XF_{rA} + Y_A \left( \frac{F_{rB}}{2Y_B} - K_a \right)$ $P_A = F_{rA}$ , where $P_A < F_{rA}$
		Bearing B	-	$P_B = F_{rB}$

- [Remarks] 1. These equations can be used when internal clearance and preload during operation are zero.  
2. Radial load is treated as positive in the calculation, if it is applied in a direction opposite that shown in Fig. above

# Single-row, matched pair angular contact ball bearings

$d$  100 ~ (130) mm

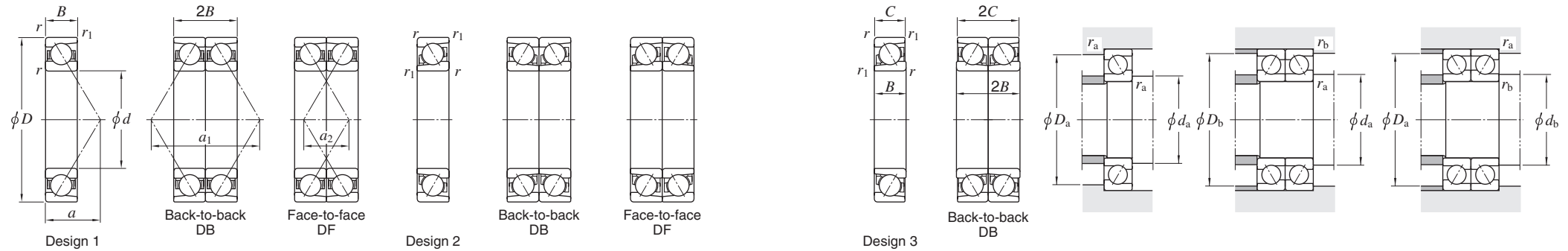

Boundary dimensions (mm)					Basic load ratings (kN)				Bearing No.			De-sign	Load center (mm)			Mounting dimensions (mm)						(Refer.) Mass Single row (kg)	
$d$	$D$	$B$	$C$	$r$ min.	$r_1$ min.	Single row		Matched pair		Single row	Back-to-back DB		Face-to-face DF	$a$	$a_1$	$a_2$	$d_a$ min.	$d_b$ min.	$D_a$ max.	$D_b$ max.	$r_a$ max.		$r_b$ max.
<b>100</b>	150	24	—	1.5	1	68.4	70.6	111	141	<b>7020</b>	<b>7020DB</b>	<b>7020DF</b>	1	48.1	96.2	48.2	108.5	—	141.5	144.5	1.5	1	1.37
	150	24	—	1.5	1	61.2	63.6	99.4	127	<b>7020B</b>	<b>7020BDB</b>	<b>7020BDF</b>	1	64.4	128.9	80.9	108.5	—	141.5	144.5	1.5	1	1.37
	180	34	—	2.1	1.1	137	117	223	235	<b>7220</b>	<b>7220DB</b>	<b>7220DF</b>	1	57.7	115.4	47.4	112	—	168	173	2	1	3.32
	180	34	—	2.1	1.1	124	107	202	214	<b>7220B</b>	<b>7220BDB</b>	<b>7220BDF</b>	1	76.2	152.3	84.3	112	—	168	173	2	1	3.32
	215	47	—	3	1.1	184	161	298	323	<b>7320</b>	<b>7320DB</b>	<b>7320DF</b>	1	69.4	138.8	44.8	114	—	201	208	2.5	1	7.53
	215	47	—	3	1.1	168	148	274	297	<b>7320B</b>	<b>7320BDB</b>	<b>7320BDF</b>	1	90.2	180.4	86.4	114	—	201	208	2.5	1	7.53
<b>105</b>	160	26	—	2	1	79.8	81.9	130	164	<b>7021</b>	<b>7021DB</b>	<b>7021DF</b>	1	51.8	103.7	51.7	115	—	150	154.5	2	1	1.73
	190	36	—	2.1	1.1	149	132	243	265	<b>7221</b>	<b>7221DB</b>	<b>7221DF</b>	1	61.0	122.1	50.1	117	—	178	183	2	1	3.95
	190	36	—	2.1	1.1	135	121	220	241	<b>7221B</b>	<b>7221BDB</b>	<b>7221BDF</b>	1	80.5	161.0	89.0	117	—	178	183	2	1	3.95
	225	49	—	3	1.1	208	193	337	386	<b>7321</b>	<b>7321DB</b>	<b>7321DF</b>	1	72.1	144.3	46.3	119	—	211	218	2.5	1	8.62
	225	49	—	3	1.1	191	177	310	355	<b>7321B</b>	<b>7321BDB</b>	<b>7321BDF</b>	1	93.7	187.5	89.5	119	—	211	218	2.5	1	8.62
<b>110</b>	170	28	—	2	1	91.9	92.8	149	186	<b>7022</b>	<b>7022DB</b>	<b>7022DF</b>	1	54.4	108.9	52.9	120	—	160	164.5	2	1	2.14
	170	28	—	2	1	82.3	83.7	134	167	<b>7022B</b>	<b>7022BDB</b>	<b>7022BDF</b>	1	72.7	145.5	89.5	120	—	160	164.5	2	1	2.14
	200	38	—	2.1	1.1	162	148	263	297	<b>7222</b>	<b>7222DB</b>	<b>7222DF</b>	1	64.3	128.7	52.7	122	—	188	193	2	1	4.65
	200	38	—	2.1	1.1	147	135	238	270	<b>7222B</b>	<b>7222BDB</b>	<b>7222BDF</b>	1	84.9	169.7	93.7	122	—	188	193	2	1	4.65
	240	50	—	3	1.1	232	226	377	452	<b>7322</b>	<b>7322DB</b>	<b>7322DF</b>	1	76.4	152.7	52.7	124	—	226	233	2.5	1	10.1
	240	50	—	3	1.1	213	208	346	416	<b>7322B</b>	<b>7322BDB</b>	<b>7322BDF</b>	1	99.6	199.3	99.3	124	—	226	233	2.5	1	10.1
<b>120</b>	180	28	—	2	1	96.6	103	157	206	<b>7024</b>	<b>7024DB</b>	<b>7024DF</b>	1	57.3	114.6	58.6	130	—	170	174.5	2	1	2.27
	180	28	—	2	1	86.4	93.0	140	186	<b>7024B</b>	<b>7024BDB</b>	<b>7024BDF</b>	1	76.9	153.9	97.9	130	—	170	174.5	2	1	2.27
	215	40	—	2.1	1.1	174	166	283	332	<b>7224</b>	<b>7224DB</b>	<b>7224DF</b>	1	68.5	137.0	57.0	132	—	203	208	2	1	5.49
	215	40	—	2.1	1.1	158	151	257	302	<b>7224B</b>	<b>7224BDB</b>	<b>7224BDF</b>	1	90.3	180.5	100.5	132	—	203	208	2	1	5.49
	260	55	—	3	1.1	246	252	400	504	<b>7324</b>	<b>7324DB</b>	<b>7324DF</b>	1	82.3	164.7	54.7	134	—	246	253	2.5	1	12.6
	260	55	—	3	1.1	225	231	366	462	<b>7324B</b>	<b>7324BDB</b>	<b>7324BDF</b>	1	107.2	214.4	104.4	134	—	246	253	2.5	1	12.6
<b>130</b>	200	33	—	2	1	117	125	191	251	<b>7026</b>	<b>7026DB</b>	<b>7026DF</b>	1	64.1	128.3	62.3	140	—	190	194.5	2	1	3.43
	200	33	—	2	1	105	113	171	226	<b>7026B</b>	<b>7026BDB</b>	<b>7026BDF</b>	1	85.7	171.5	105.5	140	—	190	194.5	2	1	3.43
	230	40	—	3	1.1	196	198	318	395	<b>7226</b>	<b>7226DB</b>	<b>7226DF</b>	1	72.0	143.9	63.9	144	—	216	223	2.5	1	6.21
	230	40	—	3	1.1	177	180	288	360	<b>7226B</b>	<b>7226BDB</b>	<b>7226BDF</b>	1	95.5	191.0	111.0	144	—	216	223	2.5	1	6.21
	280	58	—	4	1.5	301	329	489	659	<b>7326</b>	<b>7326DB</b>	<b>7326DF</b>	1	88.8	177.5	61.5	148	—	262	271.5	3	1.5	15.4

[Remark]  $a_1, a_2$ : Load center spread

# Single-row, matched pair angular contact ball bearings

$d$  (130) ~ (160) mm

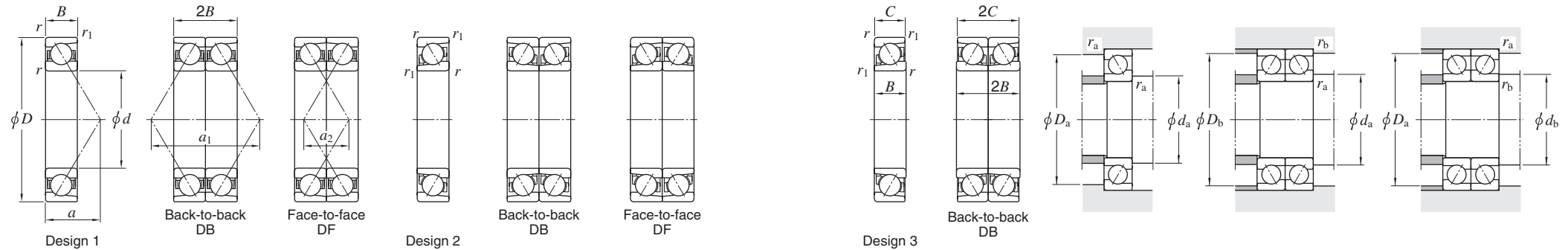

Boundary dimensions (mm)					Basic load ratings (kN)				Bearing No.			De-sign	Load center (mm)			Mounting dimensions (mm)						(Refer.) Mass Single row (kg)	
$d$	$D$	$B$	$C$	$r_{\min.}$	$r_{1\min.}$	Single row		Matched pair		Single row	Back-to-back DB		Face-to-face DF	$a$	$a_1$	$a_2$	$d_a$ min.	$d_b$ min.	$D_a$ max.	$D_b$ max.	$r_a$ max.		$r_b$ max.
130	280	58	—	4	1.5	250	268	406	536	<b>7326B</b>	<b>7326BDB</b>	<b>7326BDF</b>	1	115.0	230.0	114.0	148	—	262	271.5	3	1.5	15.4
140	190	24	—	1.5	1	79.8	93	130	186	<b>7928</b>	<b>7928DB</b>	<b>7928DF</b>	1	59.6	119.3	71.3	148.5	—	181.5	184.5	1.5	0.8	1.90
	190	24	—	1.5	1	71.1	81.3	115	163	<b>7928B</b>	<b>7928BDB</b>	<b>7928BDF</b>	1	81.2	162.5	114.5	148.5	—	181.5	184.5	1.5	0.8	1.80
	210	33	—	2	1	120	133	194	265	<b>7028</b>	<b>7028DB</b>	<b>7028DF</b>	1	67.0	134.1	68.1	150	—	200	204.5	2	1	3.64
	210	33	—	2	1	107	119	174	237	<b>7028B</b>	<b>7028BDB</b>	<b>7028BDF</b>	1	89.9	179.8	113.8	150	—	200	204.5	2	1	3.64
	250	42	—	3	1.1	218	234	355	468	<b>7228</b>	<b>7228DB</b>	<b>7228DF</b>	1	77.3	154.6	70.6	154	—	236	243	2.5	1	7.76
	250	42	—	3	1.1	197	213	320	426	<b>7228B</b>	<b>7228BDB</b>	<b>7228BDF</b>	1	102.8	205.6	121.6	154	—	236	243	2.5	1	7.76
	300	62	—	4	1.5	329	374	535	748	<b>7328</b>	<b>7328DB</b>	<b>7328DF</b>	1	94.5	189.0	65.0	158	—	282	291.5	3	1.5	18.8
	300	62	—	4	1.5	302	344	491	688	<b>7328B</b>	<b>7328BDB</b>	<b>7328BDF</b>	1	123.3	246.6	122.6	158	—	282	291.5	3	1.5	18.8
145	220	38	—	2.1	1.1	133	146	217	292	<b>AC2922</b>	<b>AC2922DB</b>	<b>AC2922DF</b>	1	71.7	143.4	67.4	157	—	208	213	2	1	4.82
150	210	28	—	2	1	107	125	174	250	<b>7930</b>	<b>7930DB</b>	<b>7930DF</b>	1	66.0	131.9	75.9	160	—	200	204.5	2	1	2.90
	210	28	—	2	1	95.7	109	156	218	<b>7930B</b>	<b>7930BDB</b>	<b>7930BDF</b>	1	89.5	179.0	123.0	160	—	200	204.5	2	1	2.90
	210	25	28	2	1	95.7	109	156	218	<b>AC3021B</b>	<b>AC3021BDB</b>	—	3	88	176	—	160	—	200	204.5	2	1	2.73
	225	35	—	2.1	1.1	137	154	222	308	<b>7030</b>	<b>7030DB</b>	<b>7030DF</b>	1	72.1	144.2	74.2	162	—	213	218	2	1	4.43
	225	35	—	2.1	1.1	122	138	199	275	<b>7030B</b>	<b>7030BDB</b>	<b>7030BDF</b>	1	96.2	192.3	122.3	162	—	213	218	2	1	4.43
	229.9	35	—	2.1	2.1	132	143	214	287	<b>AC302335B</b>	<b>AC302335BDB</b>	—	2	97.2	194.4	—	162	—	217.9	217.9	2	2	4.70
	270	45	—	3	1.1	248	280	403	560	<b>7230</b>	<b>7230DB</b>	<b>7230DF</b>	1	83.1	166.3	76.3	164	—	256	263	2.5	1	9.75
	270	45	—	3	1.1	225	254	365	509	<b>7230B</b>	<b>7230BDB</b>	<b>7230BDF</b>	1	110.6	221.2	131.2	164	—	256	263	2.5	1	9.75
	320	65	—	4	1.5	348	414	565	829	<b>7330</b>	<b>7330DB</b>	<b>7330DF</b>	1	100.3	200.7	70.7	168	—	302	311.5	3	1.5	22.4
	320	65	—	4	1.5	318	380	516	760	<b>7330B</b>	<b>7330BDB</b>	<b>7330BDF</b>	1	131.1	262.2	132.2	168	—	302	311.5	3	1.5	22.4
160	215	28	25	2	1.5	85.7	102	139	204	<b>AC3222B</b>	<b>AC3222BDB</b>	—	3	91.2	182.3	—	170	—	205	208	2	1.5	2.60
	220	28	—	2	1	109	129	177	259	<b>7932</b>	<b>7932DB</b>	<b>7932DF</b>	1	68.9	137.7	81.7	170	—	210	214.5	2	1	3.00
	220	28	—	2	1	97.1	113	158	226	<b>7932B</b>	<b>7932BDB</b>	<b>7932BDF</b>	1	93.7	187.4	131.4	170	—	210	214.5	2	1	3.00
	229.5	33	—	2	1	111	128	180	256	<b>AC322333B</b>	<b>AC322333BDB</b>	<b>AC322333BDF</b>	2	98.3	196.6	130.6	170	165.5	219.5	224	2	1	4.40
	240	38	—	2.1	1.1	155	176	252	353	<b>7032</b>	<b>7032DB</b>	<b>7032DF</b>	1	76.8	153.5	77.5	172	—	228	233	2	1	5.45
	240	38	—	2.1	1.1	139	158	225	316	<b>7032B</b>	<b>7032BDB</b>	<b>7032BDF</b>	1	102.9	205.8	129.8	172	—	228	233	2	1	5.45
	290	48	—	3	1.1	230	263	374	525	<b>7232</b>	<b>7232DB</b>	<b>7232DF</b>	1	89.0	177.9	81.9	174	—	276	283	2.5	1	12.1

[Remark]  $a_1, a_2$  : Load center spread

# Single-row, matched pair angular contact ball bearings

$d$  (160) ~ (190) mm

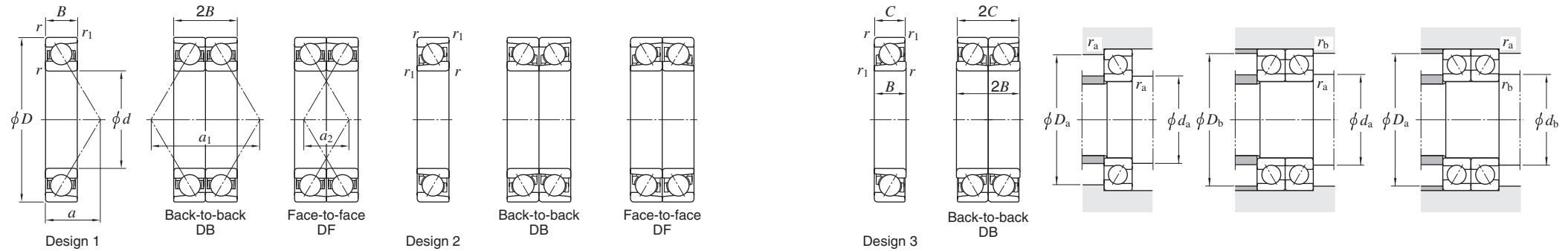

Boundary dimensions (mm)						Basic load ratings (kN)				Bearing No.			De-sign	Load center (mm)			Mounting dimensions (mm)				(Refer.) Mass Single row (kg)		
$d$	$D$	$B$	$C$	$r_{\min.}$	$r_{1\min.}$	Single row		Matched pair		Single row	Back-to-back DB	Face-to-face DF		$a$	$a_1$	$a_2$	$d_a$ min.	$d_b$ min.	$D_a$ max.	$D_b$ max.		$r_a$ max.	$r_b$ max.
<b>160</b>	290	48	—	3	1.1	238	279	386	557	<b>7232B</b>	<b>7232BDB</b>	<b>7232BDF</b>	1	118.4	236.8	140.8	174	—	276	283	2.5	1	12.1
	340	68	—	4	1.5	365	455	592	909	<b>7332</b>	<b>7332DB</b>	<b>7332DF</b>	1	106.2	212.3	76.3	178	—	322	331.5	3	1.5	26.4
	340	68	—	4	1.5	332	416	540	831	<b>7332B</b>	<b>7332BDB</b>	<b>7332BDF</b>	1	138.9	277.8	141.8	178	—	322	331.5	3	1.5	26.4
<b>170</b>	230	28	—	2	1	110	134	179	268	<b>7934</b>	<b>7934DB</b>	<b>7934DF</b>	1	71.7	143.5	87.5	180	—	220	224.5	2	1	3.20
	230	28	—	2	1	98.4	117	160	234	<b>7934B</b>	<b>7934BDB</b>	<b>7934BDF</b>	1	97.9	195.8	139.8	180	—	220	224.5	2	1	3.20
	249.5	38	—	2	1	158	186	257	371	<b>AC342538</b>	<b>AC342538DB</b>	<b>AC342538DF</b>	1	79.6	159.3	83.3	180	—	239.5	244	2	1	5.80
	249.5	38	—	2	1	141	165	229	329	<b>AC342538B</b>	<b>AC342538BDB</b>	<b>AC342538BDF</b>	2	107.1	214.2	138.2	180	175.5	239.5	244	2	1	6.10
	260	42	—	2.1	1.1	186	214	302	429	<b>7034</b>	<b>7034DB</b>	<b>7034DF</b>	1	83.1	166.2	82.2	182	—	248	253	2	1	7.58
	260	42	—	2.1	1.1	166	193	270	386	<b>7034B</b>	<b>7034BDB</b>	<b>7034BDF</b>	1	111.2	222.4	138.4	182	—	248	253	2	1	7.77
	270	40	—	2.1	1.1	176	205	285	410	<b>AC3427B</b>	<b>AC3427BDB</b>	<b>AC3427BDF</b>	2	112.3	224.6	144.6	182	177	258	263	2	1	7.30
	310	52	—	4	1.5	272	331	441	661	<b>7234</b>	<b>7234DB</b>	<b>7234DF</b>	1	95.3	190.6	86.6	188	—	292	301.5	3	1.5	15.1
	310	52	—	4	1.5	245	300	398	600	<b>7234B</b>	<b>7234BDB</b>	<b>7234BDF</b>	1	126.7	253.4	149.4	188	—	292	301.5	3	1.5	15.1
	360	72	—	4	1.5	389	485	631	969	<b>7334</b>	<b>7334DB</b>	<b>7334DF</b>	1	112.5	225.0	81.0	188	—	342	351.5	3	1.5	31.2
360	72	—	4	1.5	355	444	577	888	<b>7334B</b>	<b>7334BDB</b>	<b>7334BDF</b>	1	147.2	294.4	150.4	188	—	342	351.5	3	1.5	31.2	
<b>175</b>	235	30	27	2	1	94.2	115	153	230	<b>AC3524B</b>	<b>AC3524BDB</b>	—	3	101.0	202.0	—	185	—	225	229.5	2	1	6.40
<b>180</b>	250	33	—	2	1	141	170	229	339	<b>7936</b>	<b>7936DB</b>	<b>7936DF</b>	1	78.6	157.2	91.2	190	—	240	244.5	2	1	4.80
	250	33	—	2	1	126	148	204	296	<b>7936B</b>	<b>7936BDB</b>	<b>7936BDF</b>	1	106.7	213.4	147.4	190	—	240	244.5	2	1	4.70
	259.5	33	—	2	1	144	176	234	353	<b>AC3626</b>	<b>AC3626DB</b>	<b>AC3626DF</b>	1	80.0	160.0	94.0	190	—	249.5	254	2	1	5.60
	259.5	33	—	2	1	128	154	209	308	<b>AC3626B</b>	<b>AC3626BDB</b>	<b>AC3626BDF</b>	1	108.8	217.6	151.6	190	—	249.5	254	2	1	5.70
	265	33	—	2	2	143	170	233	341	<b>AC3627B</b>	<b>AC3627BDB</b>	—	2	110.1	220.1	—	190	—	255	255	2	2	6.3
	280	46	—	2.1	1.1	212	253	344	506	<b>7036</b>	<b>7036DB</b>	<b>7036DF</b>	1	89.4	178.8	86.8	192	—	268	273	2	1	10.1
	280	46	—	2.1	1.1	190	228	308	457	<b>7036B</b>	<b>7036BDB</b>	<b>7036BDF</b>	1	119.5	239.0	147.0	192	—	268	273	2	1	10.2
	320	52	—	4	1.5	293	362	477	724	<b>7236</b>	<b>7236DB</b>	<b>7236DF</b>	1	98.2	196.3	92.3	198	—	302	311.5	3	1.5	15.7
	320	52	—	4	1.5	265	329	430	657	<b>7236B</b>	<b>7236BDB</b>	<b>7236BDF</b>	1	130.9	261.8	157.8	198	—	302	311.5	3	1.5	15.7
	380	75	—	4	1.5	373	488	606	976	<b>7336B</b>	<b>7336BDB</b>	<b>7336BDF</b>	1	155.0	309.9	159.9	198	—	362	371.5	3	1.5	40.0
<b>190</b>	255	33	29	2	1.1	109	136	178	272	<b>AC382633B</b>	<b>AC382633BDB</b>	—	3	109.8	219.7	—	200	—	245	248	2	1	4.30
	259.5	35	—	2	SP	118	147	192	295	<b>AC382635AB</b>	<b>AC382635ABDB</b>	<b>AC382635ABDF</b>	2	111.9	223.8	153.8	200	200	249.5	249	2	1	5.00

[Note] 1) SP indicates the specially chamfered form.

[Remark]  $a_1, a_2$ : Load center spread

# Single-row, matched pair angular contact ball bearings

$d$  (190) ~ (230) mm

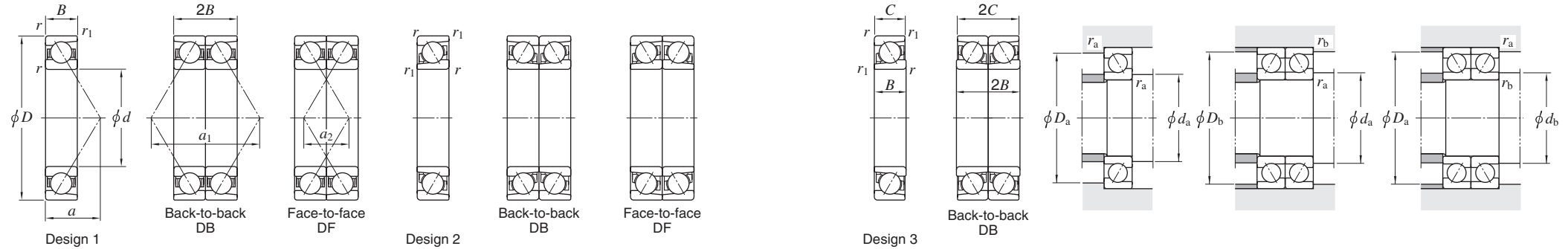

Boundary dimensions (mm)					Basic load ratings (kN)				Bearing No.	De-sign	Load center (mm)			Mounting dimensions (mm)				(Refer.) Mass Single row (kg)					
$d$	$D$	$B$	$C$	$r_{min.}$	$r_{1 min.}$	Single row $C_r$	Matched pair $C_{0r}$	Single row $C_r$			Matched pair $C_{0r}$	Back-to-back DB	Face-to-face DF	$a$	$a_1$	$a_2$	$d_a$ min.		$d_b$ min.	$D_a$ max.	$D_b$ max.	$r_a$ max.	$r_b$ max.
190	260	33	—	2	1	143	176	233	352	<b>7938</b>	<b>7938DB</b>	<b>7938DF</b>	1	81.5	162.9	96.9	200	—	250	254.5	2	1	5.00
	269.5	33	—	2	SP	146	177	237	354	<b>AC382733B</b>	<b>AC382733BDB</b>	<b>AC382733BDF</b>	2	113.0	226.0	160.0	200	196	259.5	263	2	1	6.00
	290	46	—	2.1	1.1	217	268	353	535	<b>7038</b>	<b>7038DB</b>	<b>7038DF</b>	1	92.3	184.6	92.6	202	—	278	283	2	1	10.8
	290	46	—	2.1	1.1	194	241	316	483	<b>7038B</b>	<b>7038BDB</b>	<b>7038BDF</b>	1	123.7	247.4	155.4	202	—	278	283	2	1	10.8
	340	55	—	4	1.5	303	390	493	779	<b>7238</b>	<b>7238DB</b>	<b>7238DF</b>	1	104.0	208.0	98.0	208	—	322	331.5	3	1.5	18.8
	340	55	—	4	1.5	273	353	443	706	<b>7238B</b>	<b>7238BDB</b>	<b>7238BDF</b>	1	138.7	277.4	167.4	208	—	322	331.5	3	1.5	18.8
	400	78	—	5	2	411	548	668	1 100	<b>7338B</b>	<b>7338BDB</b>	<b>7338BDF</b>	1	162.8	325.5	169.5	212	—	378	390	4	2	45.5
200	279.5	38	—	2.1	1.1	161	194	261	388	<b>AC4028B</b>	<b>AC4028BDB</b>	<b>AC4028BDF</b>	2	119.7	239.4	163.4	212	207	267.5	272.5	2	1	6.90
	280	38	—	2.1	1.1	180	222	293	444	<b>7940</b>	<b>7940DB</b>	<b>7940DF</b>	1	88.3	176.6	100.6	212	—	268	273	2	1	7.00
	280	38	—	2.1	1.1	161	194	261	388	<b>7940B</b>	<b>7940BDB</b>	<b>7940BDF</b>	1	119.7	239.4	163.4	212	—	268	273	2	1	7.00
	289.5	38	—	2.1	1.1	172	211	279	421	<b>AC4029B</b>	<b>AC4029BDB</b>	<b>AC4029BDF</b>	2	121.8	243.6	167.6	212	207	277.5	282.5	2	1	8.1
	310	46	—	3	1.1	219	274	356	547	<b>AC403146B</b>	<b>AC402146BDB</b>	<b>AC403146BDF</b>	2	130.0	260.0	168	214	214	296	303	2.5	1	13.1
	310	51	—	2.1	1.1	244	309	396	618	<b>7040</b>	<b>7040DB</b>	<b>7040DF</b>	1	99.1	198.3	96.3	212	—	298	303	2	1	12.7
	310	51	—	2.1	1.1	218	279	355	558	<b>7040B</b>	<b>7040BDB</b>	<b>7040BDF</b>	1	132.5	265.0	163.0	212	—	298	303	2	1	12.7
	360	58	—	4	1.5	324	423	526	847	<b>7240</b>	<b>7240DB</b>	<b>7240DF</b>	1	109.8	219.7	103.7	218	—	342	351.5	3	1.5	22.4
	360	58	—	4	1.5	292	384	474	768	<b>7240B</b>	<b>7240BDB</b>	<b>7240BDF</b>	1	146.5	292.9	176.9	218	—	342	351.5	3	1.5	22.4
	420	80	—	5	2	474	658	770	1 320	<b>7340</b>	<b>7340DB</b>	<b>7340DF</b>	1	129.5	259.0	99.0	222	—	398	410	4	2	52.0
420	80	—	5	2	432	602	702	1 200	<b>7340B</b>	<b>7340BDB</b>	<b>7340BDF</b>	1	170.1	340.1	180.1	222	—	398	410	4	2	52.0	
210	299.5	38	—	2.1	1.1	209	268	340	536	<b>AC4230</b>	<b>AC4230DB</b>	<b>AC4230DF</b>	1	92.6	185.2	109.2	222	—	287.5	292.5	2	1	8.60
220	300	35	38	2.1	1.1	160	203	259	405	<b>AC4430B</b>	<b>AC4430BDB</b>	—	3	126.6	253.2	—	232	—	288	293	2	1	7.4
	309.5	38	—	2.1	1.1	178	227	289	454	<b>AC443138B</b>	<b>AC443138BDB</b>	<b>AC443138BDF</b>	2	130.2	260.4	184.4	232	227	297.5	302.5	2	1	8.90
	319.5	46	—	2.1	1.1	212	281	345	562	<b>AC443246B</b>	<b>AC443246BDB</b>	<b>AC443246BDF</b>	2	136.3	272.6	180.6	232	227	307.5	312.5	2	1	12.0
	340	56	—	3	1.1	267	353	434	705	<b>7044</b>	<b>7044DB</b>	<b>7044DF</b>	1	108.9	217.8	105.8	234	—	326	333	2.5	1	18.5
	340	56	—	3	1.1	239	318	389	636	<b>7044B</b>	<b>7044BDB</b>	<b>7044BDF</b>	1	145.5	290.9	178.9	234	—	326	333	2.5	1	18.9
	400	65	—	4	1.5	375	515	610	1 030	<b>7244</b>	<b>7244DB</b>	<b>7244DF</b>	1	122.0	244.0	114	238	—	382	391.5	3	1.5	35.2
	460	88.5	—	5	2	542	795	881	1 590	<b>AC4446</b>	<b>AC4446DB</b>	<b>AC4446DF</b>	1	142.1	284.3	108.3	242	—	438	450	4	2	37.5
230	320	40	—	2.1	1.1	181	235	294	471	<b>AC4632B</b>	<b>AC4632BDB</b>	<b>AC4632BDF</b>	1	135.4	270.8	190.8	242	—	308	313	2	1	9.6

[Note] 1) SP indicates the specially chamfered form.

[Remark]  $a_1, a_2$  : Load center spread



# Single-row, matched pair angular contact ball bearings

$d$  (230) ~ 290 mm

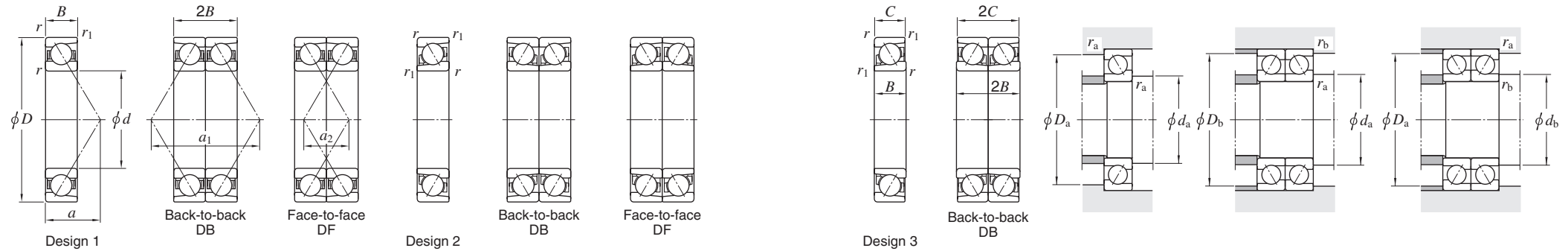

Boundary dimensions (mm)						Basic load ratings (kN)				Bearing No.			De-sign	Load center (mm)			Mounting dimensions (mm)						(Refer.) Mass Single row (kg)
$d$	$D$	$B$	$C$	$r_{min.}$	$r_{1 min.}$	Single row		Matched pair		Single row	Back-to-back DB	Face-to-face DF		$a$	$a_1$	$a_2$	$d_a$ min.	$d_b$ min.	$D_a$ max.	$D_b$ max.	$r_a$ max.	$r_b$ max.	
230	339.5	45	—	3	1.1	227	310	369	619	<b>AC4634B</b>	<b>AC4634BDB</b>	<b>AC4634BDF</b>	2	142.1	284.1	194.1	244	237	325.5	332.5	2.5	1	13.9
240	320	38	—	2.1	1.1	193	255	313	510	<b>7948</b>	<b>7948DB</b>	<b>7948DF</b>	1	99.8	199.7	123.7	252	—	308	313	2	1	8.00
	320	38	—	2.1	1.1	171	223	278	446	<b>7948B</b>	<b>7948BDB</b>	<b>7948BDF</b>	1	136.5	272.9	196.9	252	—	308	313	2	1	8.00
	329.5	40	—	2.1	1.1	197	265	320	529	<b>AC4833B</b>	<b>AC4833BDB</b>	<b>AC4833BDF</b>	2	139.6	279.1	199.1	252	247	317.5	322.5	2	1	9.80
	360	56	—	3	1.1	273	375	443	751	<b>7048</b>	<b>7048DB</b>	<b>7048DF</b>	1	114.6	229.2	117.2	254	—	346	353	2.5	1	19.7
	360	56	—	3	1.1	244	338	397	677	<b>7048B</b>	<b>7048BDB</b>	<b>7048BDF</b>	1	153.9	307.7	195.7	254	—	346	353	2.5	1	20.1
250	340	35	38	2.1	1.5	173	230	281	460	<b>AC5034B</b>	<b>AC5034BDB</b>	—	3	141.3	282.5	—	262	—	328	331.5	2	1.5	9.6
	349.5	46	—	2.1	1.1	220	303	357	606	<b>AC503546B</b>	<b>AC503546BDB</b>	<b>AC503546BDF</b>	2	148.9	297.7	205.7	262	—	337.5	342.5	2	1	13.2
260	360	46	—	2.1	1.1	251	360	408	720	<b>7952</b>	<b>7952DB</b>	<b>7952DF</b>	1	112.5	225.1	133.1	272	—	348	353	2	1	13.8
	360	46	—	2.1	1.1	218	302	354	604	<b>7952B</b>	<b>7952BDB</b>	<b>7952BDF</b>	1	153.1	306.1	214.1	272	—	348	353	2	1	13.9
	369.5	46	—	2.1	2.1	247	353	401	706	<b>AC523746B</b>	<b>AC523746BDB</b>	<b>AC523746BDF</b>	2	155.2	310.3	218.3	272	272	357.5	357.5	2	2	15.5
	379.5	56	—	3	1.1	264	387	429	774	<b>AC5238B</b>	<b>AC5238BDB</b>	<b>AC5238BDF</b>	2	162.3	324.5	212.5	274	267	365.5	372.5	2.5	1	20.6
	400	65	—	4	1.5	325	478	529	956	<b>7052</b>	<b>7052DB</b>	<b>7052DF</b>	1	128.4	256.7	126.7	278	—	382	391.5	3	1.5	28.7
	400	65	—	4	1.5	291	431	473	862	<b>7052B</b>	<b>7052BDB</b>	<b>7052BDF</b>	1	171.0	341.9	211.9	278	—	382	391.5	3	1.5	29.3
270	379.5	46	—	2.1	1.1	252	367	409	735	<b>AC5438B</b>	<b>AC5438BDB</b>	<b>AC5438BDF</b>	2	159.4	318.7	226.7	282	277	367.5	372.5	2	1	24.3
280	380	46	—	2.1	1.1	254	372	413	744	<b>7956</b>	<b>7956DB</b>	<b>7956DF</b>	1	118.3	236.6	144.6	292	—	368	373	2	1	14.2
	380	46	—	2.1	1.1	226	325	368	651	<b>7956B</b>	<b>7956BDB</b>	<b>7956BDF</b>	1	161.5	322.9	230.9	292	—	368	373	2	1	14.7
	389.5	46	—	2.1	SP	257	381	417	763	<b>AC563946AB</b>	<b>AC563946ABDB</b>	<b>AC563946ABDF</b>	2	163.5	327.1	235.1	292	287	377.5	382	2	1	16.5
	400	52	—	4	1.5	268	401	435	803	<b>AC5640B</b>	<b>AC5640BDB</b>	<b>AC5640BDF</b>	1	228.6	457.2	353.2	298	—	382	391.5	3	1.5	20.5
	420	65	—	4	1.5	332	507	540	1 010	<b>7056</b>	<b>7056DB</b>	<b>7056DF</b>	1	133.5	267.1	137.1	298	—	402	411.5	3	1.5	30.4
	420	65	—	4	1.5	297	453	483	906	<b>7056B</b>	<b>7056BDB</b>	<b>7056BDF</b>	1	179.3	358.7	228.7	298	—	402	411.5	3	1.5	31.0
285	380	46	—	3	1.1	206	296	334	592	<b>AC5738</b>	<b>AC5738DB</b>	<b>AC5738DF</b>	1	119.0	238.0	146.0	299	—	366	373	2.5	1	14.1
	380	46	—	2	2	204	291	331	582	<b>AC5738B</b>	<b>AC5738BDB</b>	<b>AC5738BDF</b>	2	162.7	325.4	233.4	295	—	370	370	2	2	14.2
290	409.5	56	—	3	1.1	285	438	464	875	<b>AC584156B</b>	<b>AC584156BDB</b>	<b>AC584156BDF</b>	2	174.8	349.7	237.7	304	297	395.5	402.5	2.5	1	22.5
	419.5	60	—	4	1.5	292	455	475	910	<b>AC5842B</b>	<b>AC5842BDB</b>	<b>AC5842BDF</b>	2	178.9	357.9	237.9	308	298.5	401.5	411	3	1.5	26.5

[Note] 1) SP indicates the specially chamfered form.

[Remark]  $a_1, a_2$  : Load center spread

# Single-row, matched pair angular contact ball bearings

$d$  300 ~ 670 mm

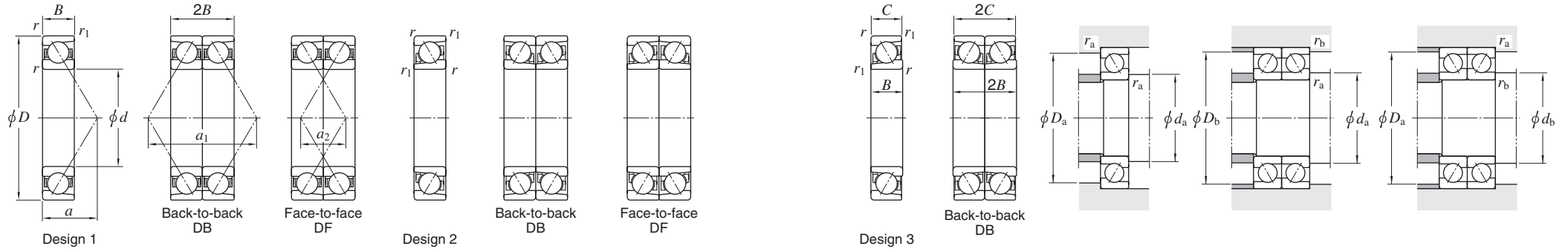

Boundary dimensions (mm)					Basic load ratings (kN)				Single row	Bearing No.		De-sign	Load center (mm)			Mounting dimensions (mm)						(Refer.) Mass Single row (kg)	
$d$	$D$	$B$	$C$	$r_{\min.}$	$r_{1\min.}$	Single row $C_r$	Matched pair $C_{0r}$	Matched pair $C_r$		Matched pair $C_{0r}$	Back-to-back DB		Face-to-face DF	$a$	$a_1$	$a_2$	$d_a$ min.	$d_b$ min.	$D_a$ max.	$D_b$ max.	$r_a$ max.		$r_b$ max.
300	419.5	56	—	3	1.1	283	436	460	873	<b>AC604245B</b> <b>7060B</b>	<b>AC604256BDB</b> <b>7060BDB</b>	<b>AC604256BDF</b> <b>7060BDF</b>	2	179	358.1	246.1	314	307	405.5	412.5	2.5	1	23
	460	74	—	4	1.5	382	613	621	1 230				1	196.4	392.9	244.9	318	—	442	451.5	3	1.5	44.9
310	429.5	60	—	4	1.5	282	435	457	870	<b>AC624360B</b>	<b>AC624360BDB</b>	<b>AC624360BDF</b>	2	185.2	370.5	250.5	328	318.5	411.5	421	3	1.5	24.5
320	449.5	56	—	3	1.1	318	513	517	1 030	<b>AC644556B</b>	<b>AC644556BDB</b>	<b>AC644556BDF</b>	2	189.5	379.1	267.1	334	327	435.5	442.5	2.5	1	27.4
340	479.5	65	—	3	1.1	354	595	575	1 190	<b>AC6848B</b>	<b>AC6848BDB</b>	<b>AC6848BDF</b>	2	204.5	409.0	279.0	354	347	465.5	472.5	2.5	1	35.7
350	559.5	86	—	4	1.5	527	952	856	1 900	<b>AC7056B</b>	<b>AC7056BDB</b>	<b>AC7056BDF</b>	2	233.9	467.8	295.8	368	358.5	541.5	551	3	1.5	81.6
360	509.5	70	—	5	2	380	656	617	1 310	<b>AC7251B</b> <b>AC725482B</b>	<b>AC7251BDB</b> <b>AC725482BDB</b>	<b>AC7251BDF</b> <b>AC725482BDF</b>	1	217.5	435	295	382	—	487.5	499.5	4	2	42.9
	539.5	82	—	4	1.5	461	824	750	1 650				2	229.8	459.6	295.6	378	368.5	521.5	531	3	1.5	63.5
380	480	46	—	2.1	1.1	252	416	410	833	<b>7876B</b> <b>AC7652AB</b> <b>AC7654B</b>	<b>7876BDB</b> <b>AC7652ABDB</b> <b>AC7654BDB</b>	<b>7876BDF</b> <b>AC7652ABDF</b> <b>AC7654BDF</b>	1	203.4	406.8	314.8	392	—	468	473	2	1	18.8
	519.5	65	—	4	1.5	339	590	551	1 180				2	221.3	442.6	312.6	398	388.5	501.5	511	3	1.5	39.2
	540	82	—	4	1.1	416	747	676	1 490				1	234.0	468.0	304.0	398	—	522	533	3	1	58.3
400	559.5	70	—	4	1.5	402	734	653	1 470	<b>AC8056B</b>	<b>AC8056BDB</b>	<b>AC8056BDF</b>	2	236.4	472.8	332.8	418	408.5	541.5	551	3	1.5	52.1
420	559.5	65	—	4	1.5	375	683	609	1 370	<b>AC8456B</b>	<b>AC8456BDB</b>	<b>AC8456BDF</b>	2	238.1	476.2	346.2	438	428.5	541.5	551	3	1.5	55.9
500	620	56	—	3	1.1	380	740	617	1 480	<b>78/500</b>	<b>78/500DB</b>	<b>78/500DF</b>	1	189.7	379.4	267.4	514	—	606	613	2.5	1	35.5
530	780	112	—	6	3	807	1 810	1 310	3 620	<b>70/530</b>	<b>70/530DB</b>	<b>70/530DF</b>	1	245.1	490.2	266.2	558	—	752	766	5	2.5	174
560	750	85	—	5	2	541	1 170	878	2 330	<b>79/560B</b>	<b>79/560BDB</b>	<b>79/560BDF</b>	1	231.6	463.2	293.2	582	—	728	740	4	2	102
670	900	103	—	6	3	703	1 680	1 140	3 370	<b>79/670B</b>	<b>79/670BDB</b>	<b>79/670BDF</b>	1	380.8	761.7	555.7	698	—	872	886	5	2.5	178

[Remark]  $a_1, a_2$  : Load center spread

# Double-row angular contact ball bearings

*d* 120 ~ 280 mm

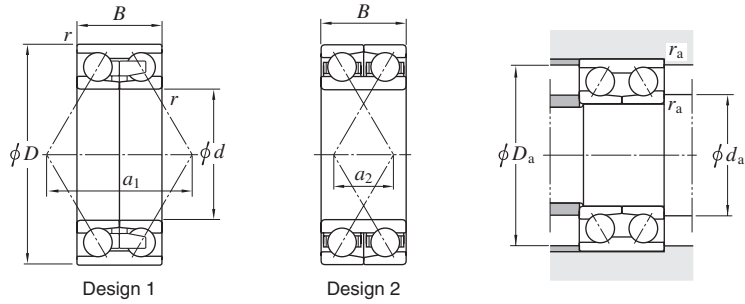

Boundary dimensions (mm)				Basic load ratings (kN)		Bearing No. <sup>1)</sup>	De- sign	Load center spread (mm)	Mounting dimensions (mm)			(Refer.) Mass (kg)
<i>d</i>	<i>D</i>	<i>B</i>	<i>r</i> <sub>min.</sub>	<i>C<sub>r</sub></i>	<i>C<sub>0r</sub></i>				<i>a</i> <sub>1</sub> , <i>a</i> <sub>2</sub>	<i>d<sub>a</sub></i> <sub>min.</sub>	<i>D<sub>a</sub></i> <sub>max.</sub>	
<b>120</b>	190	66	2	167	213	<b>2AC2419B</b>	1	163.1	130	180	2	6.90
<b>140</b>	210	66	2	185	249	<b>305275-1</b>	1	142.4	150	200	2	7.80
<b>150</b>	225	73	2.1	216	293	<b>305333-1</b>	1	145.0	162	213	2	10.0
	230	70	2.1	215	294	<b>305283-1</b>	1	144.7	162	218	2	10.0
<b>160</b>	239.5	76	2.1	252	352	<b>305183/1D</b>	2	77.7	172	227	2	11.1
<b>170</b>	260	84	2.1	270	386	<b>305180-1</b>	2	138.8	182	248	2	13.0
<b>180</b>	259.5	66	2	212	326	<b>305262-1</b>	1	160.0	190	249.5	2	11.0
	280	92	2.1	308	457	<b>305172B-1</b>	2	147.4	192	268	2	17.0
<b>190</b>	269.5	66	2.1	209	324	<b>305338A-1</b>	1	165.8	202	257.5	2	12.0
	290	92	2.1	341	510	<b>305178</b>	1	184.6	202	278	2	21.5
<b>200</b>	279.5	76	2.1	257	388	<b>305424</b>	2	100.6	212	267.5	2	14.0
	279.5	76	2.1	257	388	<b>305428-1</b>	1	176.6	212	267.5	2	14.0
	289.5	76	2.1	312	479	<b>305263-1</b>	1	179.5	212	277.5	2	16.5
<b>220</b>	309.5	76	2.1	278	448	<b>305272-1</b>	1	191.0	230	299.5	2	22.0
	319.5	92	2.1	345	562	<b>2AC4432B-1</b>	1	230.6	232	307.5	2	24.0
<b>230</b>	329.5	80	2.1	337	559	<b>305264-1</b>	1	201.7	242	317.5	2	22.0
<b>260</b>	369.5	92	2.1	428	765	<b>305270-1</b>	1	227.9	272	357.5	2	31.0
<b>280</b>	389.5	92	2.1	406	744	<b>305269-1</b>	1	239.4	292	377.5	2	33.0

[Note] 1) Bearing No.305275-1 and 305262-1 indicate nominal contact angle of 32°. Bearing No. 2AC2419B, 305180-1, 305172B-1, and 2AC4432B-1 indicate nominal contact angle of 40°, and nominal contact angle of other bearings is 30°.

[Remark] 1) Some of these bearings have lubrication grooves or lubrication holes on their outer rings.

# Cylindrical roller bearings



- Cylindrical roller bearings feature high radial load capacity because the rollers and raceway are in linear contact. These bearings are suitable for applications that involve heavy radial and impact loading.
- They are appropriate for high-speed applications in that they can be machined very accurately due to their structure.
- The NU and N types exhibit their best performance when used as free side bearings since they adjust to the shaft's axial movement, to a certain extent, relative to the housing position.
- The NJ and NF types carry axial load in one direction, while the NUP type can carry a certain degree of axial load in both directions.

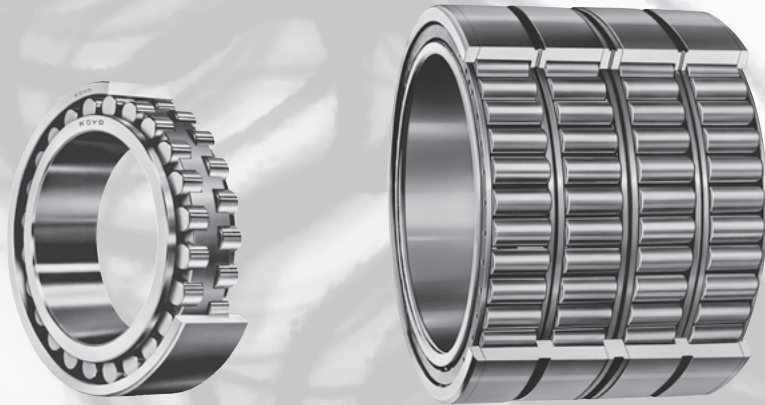

- Double-row cylindrical roller bearings come in two types : with a cylindrical bore, and with a tapered bore. As for those with a tapered bore, the specified amount of clearance can be obtained by adjusting the press-in distance. Some bearings have lubrication holes and lubrication grooves on the outer ring. They are identified by supplementary code "W".

■ Single-row (page 120)

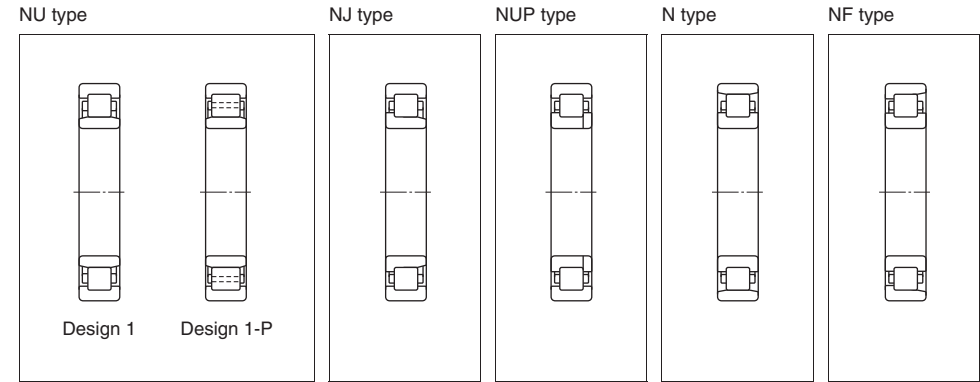

■ Double-row (page 134)

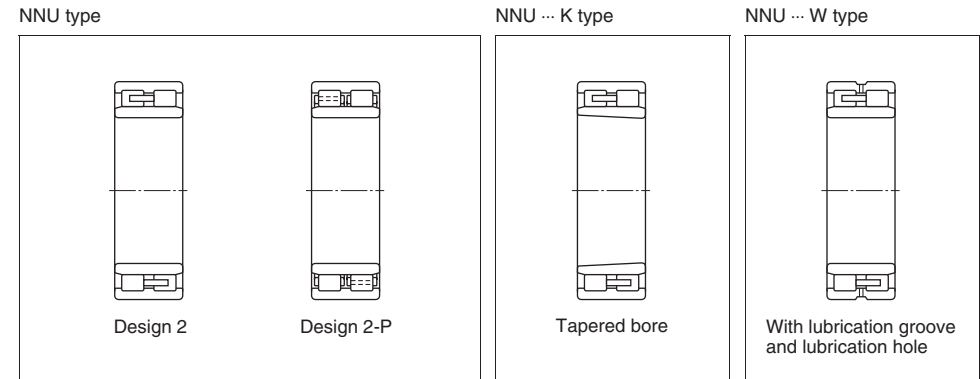
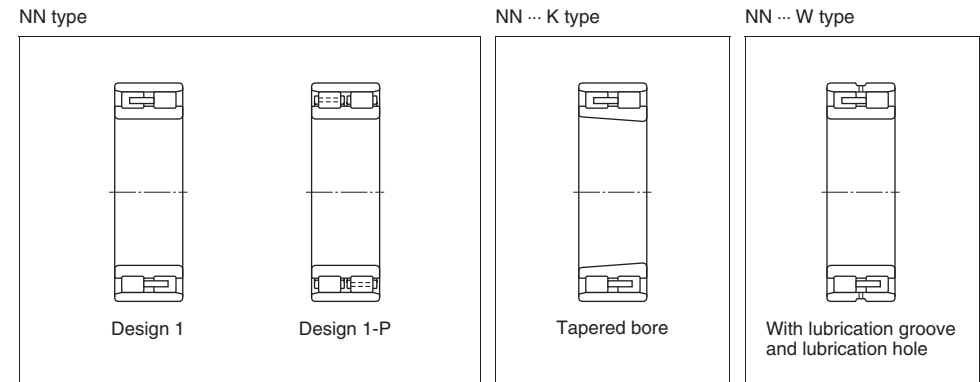

■ Four-row ... Cylindrical bore (page 142)

	Outer ring with rib	Outer ring with loose rib
One inner ring	<p>Design 1-1    Design 1-2    Design 1-3    Design 1-4</p>	<p>Design 1-6P</p>
Two inner rings	<p>Design 2-1P    Design 2-2    Design 2-2P    Design 2-3    Design 2-4</p>	<p>Design 2-5P    Design 2-6P</p>
Oil mist lubrication		<p>Design 3-1    Design 3-1P    Design 3-2P</p>

- Four-row cylindrical roller bearings, having superior resistance to radial load, are suitable for use at a high-speed.
- Since the inner ring raceway surface and the roll can be finished simultaneously after the inner ring is mounted on the roll neck (the inner ring raceway surface is grounded by a roll grinding machine, and then, the roll barrel is finished based on the grounded surface), rolling accuracy is improved. Additionally, residual clearance of the bearing can be adjusted freely.
- Some four-row cylindrical roller bearings have nozzle holes and O-rings for oil mist lubrication.

■ Four-row ... Tapered bore (page 168)

<p>Design 1-1    Design 1-2</p>	<p>Design 1-3P    Design 1-4    Design 2-2    Design 2-3</p>
---------------------------------	--

<b>Boundary dimensions</b>	The dimensions of standard series are as specified in JIS B 1512.																																																																																																										
<b>Tolerances</b>	<p>As specified in JIS B 1514.</p> <ul style="list-style-type: none"> <li>• Single-row, double-row and four-row cylindrical bore bearings...Classes 0, 6 and 5</li> <li>• Four-row tapered bore bearings...Classes 0 and 6 (refer to Table 2-2 on page 14)</li> </ul> <p style="text-align: center;"><b>Tolerances of roller set bore diameter <math>F_w</math> and roller set outside diameter <math>E_w</math> of interchangeable bearings</b></p> <p style="text-align: right;">Unit : <math>\mu\text{m}</math></p> <table border="1" style="width: 100%; border-collapse: collapse;"> <thead> <tr> <th colspan="2" rowspan="2">Nominal bore diameter <math>d</math> (mm)</th> <th colspan="2">Roller set bore diameter deviation <math>\Delta F_w</math></th> <th colspan="2">Roller set outside diameter deviation <math>\Delta E_w</math></th> </tr> <tr> <th>upper</th> <th>lower</th> <th>upper</th> <th>lower</th> </tr> </thead> <tbody> <tr> <td>over</td> <td>up to</td> <td></td> <td></td> <td></td> <td></td> </tr> <tr> <td>50</td> <td>120</td> <td>+ 20</td> <td>0</td> <td>0</td> <td>- 20</td> </tr> <tr> <td>120</td> <td>200</td> <td>+ 25</td> <td>0</td> <td>0</td> <td>- 25</td> </tr> <tr> <td>200</td> <td>250</td> <td>+ 30</td> <td>0</td> <td>0</td> <td>- 30</td> </tr> <tr> <td>250</td> <td>315</td> <td>+ 35</td> <td>0</td> <td>0</td> <td>- 35</td> </tr> <tr> <td>315</td> <td>400</td> <td>+ 40</td> <td>0</td> <td>0</td> <td>- 40</td> </tr> <tr> <td>400</td> <td>500</td> <td>+ 45</td> <td>0</td> <td>0</td> <td>- 45</td> </tr> <tr> <td>500</td> <td>600</td> <td>+ 50</td> <td>0</td> <td>0</td> <td>- 50</td> </tr> <tr> <td>600</td> <td>700</td> <td>+ 55</td> <td>0</td> <td>0</td> <td>- 55</td> </tr> <tr> <td>700</td> <td>800</td> <td>+ 60</td> <td>0</td> <td>0</td> <td>- 60</td> </tr> <tr> <td>800</td> <td>900</td> <td>+ 70</td> <td>0</td> <td>0</td> <td>- 70</td> </tr> <tr> <td>900</td> <td>1 000</td> <td>+ 80</td> <td>0</td> <td>0</td> <td>- 80</td> </tr> <tr> <td>1 000</td> <td>1 250</td> <td>+ 90</td> <td>0</td> <td>0</td> <td>- 90</td> </tr> <tr> <td>1 250</td> <td>1 600</td> <td>+100</td> <td>0</td> <td>0</td> <td>-100</td> </tr> <tr> <td>1 600</td> <td>2 000</td> <td>+120</td> <td>0</td> <td>0</td> <td>-120</td> </tr> <tr> <td>2 000</td> <td>2 500</td> <td>+150</td> <td>0</td> <td>0</td> <td>-150</td> </tr> </tbody> </table> <p>[Remark] Interchangeable bearings have an inner ring with rollers that can be matched with the outer ring, or an outer ring with rollers that can be matched with the inner ring, without affecting performance in the bearing that has the same bearing number in one category.</p>	Nominal bore diameter $d$ (mm)		Roller set bore diameter deviation $\Delta F_w$		Roller set outside diameter deviation $\Delta E_w$		upper	lower	upper	lower	over	up to					50	120	+ 20	0	0	- 20	120	200	+ 25	0	0	- 25	200	250	+ 30	0	0	- 30	250	315	+ 35	0	0	- 35	315	400	+ 40	0	0	- 40	400	500	+ 45	0	0	- 45	500	600	+ 50	0	0	- 50	600	700	+ 55	0	0	- 55	700	800	+ 60	0	0	- 60	800	900	+ 70	0	0	- 70	900	1 000	+ 80	0	0	- 80	1 000	1 250	+ 90	0	0	- 90	1 250	1 600	+100	0	0	-100	1 600	2 000	+120	0	0	-120	2 000	2 500	+150	0	0	-150
Nominal bore diameter $d$ (mm)				Roller set bore diameter deviation $\Delta F_w$		Roller set outside diameter deviation $\Delta E_w$																																																																																																					
		upper	lower	upper	lower																																																																																																						
over	up to																																																																																																										
50	120	+ 20	0	0	- 20																																																																																																						
120	200	+ 25	0	0	- 25																																																																																																						
200	250	+ 30	0	0	- 30																																																																																																						
250	315	+ 35	0	0	- 35																																																																																																						
315	400	+ 40	0	0	- 40																																																																																																						
400	500	+ 45	0	0	- 45																																																																																																						
500	600	+ 50	0	0	- 50																																																																																																						
600	700	+ 55	0	0	- 55																																																																																																						
700	800	+ 60	0	0	- 60																																																																																																						
800	900	+ 70	0	0	- 70																																																																																																						
900	1 000	+ 80	0	0	- 80																																																																																																						
1 000	1 250	+ 90	0	0	- 90																																																																																																						
1 250	1 600	+100	0	0	-100																																																																																																						
1 600	2 000	+120	0	0	-120																																																																																																						
2 000	2 500	+150	0	0	-150																																																																																																						
<b>Allowable misalignment</b>	<p>Allowable misalignment of single-row cylindrical roller bearings depends on bearing type and specification.</p> <p>General values are as follows :</p> <ol style="list-style-type: none"> <li>1) When <math>P_r / C_r</math> is approx. 10% under load of normal use .....0.000 6 rad (2') - 0.000 9 rad (3')</li> <li>2) When <math>P_r / C_r</math> is approx. 6% under load lighter than 1) .....0.001 2 rad (4')</li> </ol> <p>When very large allowable misalignment is required, consult with JTEKT.</p>																																																																																																										
<b>Radial internal clearance</b>	(refer to Table 4-4 on pages 47, 48)																																																																																																										

<b>Standard cages</b>	Machined cage or pin type cage																						
<b>Equivalent radial load</b>	<p><b>Dynamic equivalent radial load</b> ..... <math>P_r = F_r</math></p> <p><b>Static equivalent radial load</b> ..... <math>P_{0r} = F_r</math></p>																						
<b>Allowable axial load</b>	<p>Cylindrical roller bearings with ribs, including loose rib, on both inner and outer rings accommodate axial load to a certain extent.</p> <p>In such cases, axial load capacity is controlled by the condition of roller end faces, forms of rib or loose rib, lubrication, rotational speed etc.</p> <p>For certain special uses, a design is available to accommodate very heavy axial loads. In general, axial loads allowable for cylindrical roller bearings can be calculated using the following equation, which are based on empirical data.</p> $F_{ap} = 9.8 f_a \cdot f_b \cdot f_p \cdot d_m^2$ <p>where :</p> <ul style="list-style-type: none"> <li><math>F_{ap}</math> : maximum allowable axial load N</li> <li><math>f_a</math> : coefficient determined from loading condition (see below)</li> <li><math>f_b</math> : coefficient determined from bearing diameter series (see below)</li> <li><math>f_p</math> : coefficient for rib surface pressure (see below)</li> </ul> <p><math>d_m</math> : mean value of bore diameter <math>d</math> and outside diameter <math>D</math> ... <math>\left( \frac{d+D}{2} \right)</math> mm</p> <table border="1" style="width: 100%; border-collapse: collapse;"> <thead> <tr> <th>Loading condition</th> <th><math>f_a</math></th> <th>Diameter series</th> <th><math>f_b</math></th> </tr> </thead> <tbody> <tr> <td rowspan="2">Continuous loading</td> <td rowspan="2">1</td> <td>8</td> <td>0.4</td> </tr> <tr> <td>9</td> <td>0.6</td> </tr> <tr> <td rowspan="2">Intermittent loading</td> <td rowspan="2">2</td> <td>0</td> <td>0.7</td> </tr> <tr> <td>2</td> <td>0.8</td> </tr> <tr> <td rowspan="2">Instantaneous loading</td> <td rowspan="2">3</td> <td>3</td> <td>1.0</td> </tr> <tr> <td>4</td> <td>1.2</td> </tr> </tbody> </table> <p style="text-align: center;"><b>Relationship between coefficient <math>f_p</math> and value <math>d_m n</math> (<math>n</math> : rotational speed, <math>\text{min}^{-1}</math>)</b></p>	Loading condition	$f_a$	Diameter series	$f_b$	Continuous loading	1	8	0.4	9	0.6	Intermittent loading	2	0	0.7	2	0.8	Instantaneous loading	3	3	1.0	4	1.2
Loading condition	$f_a$	Diameter series	$f_b$																				
Continuous loading	1	8	0.4																				
		9	0.6																				
Intermittent loading	2	0	0.7																				
		2	0.8																				
Instantaneous loading	3	3	1.0																				
		4	1.2																				

# Single-row cylindrical roller bearings

$d$  100 ~ (120) mm

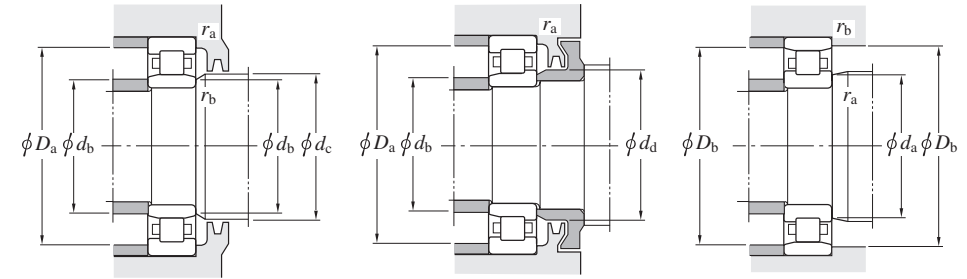
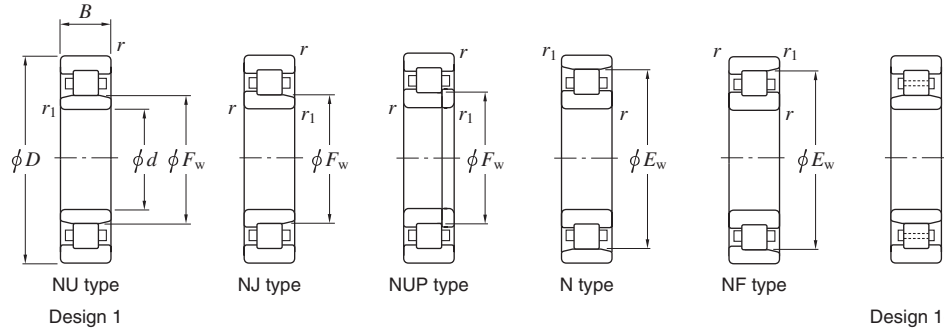

Boundary dimensions (mm)							Basic load ratings (kN)		Bearing No. <sup>1)</sup>	De- sign	Mounting dimensions (mm)									(Refer.) Mass NU (kg)	
$d$	$D$	$B$	$r$ min.	$r_1$ min.	$F_w$	$E_w$	$C_r$	$C_{0r}$	NU		$d_a$ min.	$d_b$ min.	$d_b$ max.	$d_c$ min.	$d_d$ min.	$D_a$ max.	$D_b$ max.	$D_b$ min.	$r_a$ max.	$r_b$ max.	
100	150	24	1.5	1.1	113	138	91.0	120	NU1020	1	108	106.5	111	116	—	142	—	—	1.5	1	1.46
	180	34	2.1	2.1	120	160	183	217	NU220	1	111	111	117	122	130	169	169	164	2	2	3.38
	180	34	2.1	2.1	119	163	250	306	NU220R	1	111	111	117	122	130	169	—	—	2	2	3.52
	180	46	2.1	2.1	120	160	259	338	NU2220	1	111	111	117	122	130	169	—	—	2	2	4.67
	180	46	2.1	2.1	119	163	334	444	NU2220R	1	111	111	117	122	130	169	—	—	2	2	4.82
	180	60.3	2.1	2.1	120	160	327	459	NU3220	1	111	111	117	122	—	169	—	—	2	2	6.62
	215	47	3	3	129.5	185.5	323	337	NU320	1	113	113	125	132	143	202	202	190	2.5	2.5	7.70
	215	47	3	3	127.5	191.5	379	424	NU320R	1	113	113	125	132	143	202	—	—	2.5	2.5	7.75
	215	73	3	3	129.5	185.5	464	548	NU2320	1	113	113	125	132	143	202	—	—	2.5	2.5	11.9
	215	73	3	3	127.5	191.5	570	717	NU2320R	1	113	113	125	132	143	202	—	—	2.5	2.5	12.1
215	82.6	3	3	129.5	185.5	530	706	NU3320	1	113	113	125	132	—	202	—	—	2.5	2.5	15.0	
105	160	26	2	1.1	119.5	145.5	108	149	NU1021	1	114	111.5	118	122	—	151	—	—	2	1	1.85
	190	36	2.1	2.1	126.8	168.8	201	241	NU221	1	116	116	124	129	137	179	179	173	2	2	4.00
	225	49	3	3	135	195	366	417	NU321	1	118	118	132	137	149	212	212	199	2.5	2.5	8.76
	225	77	3	3	135	195	568	750	NU2321	1	118	118	131	138	—	212	—	—	2.5	2.5	15.6
110	170	28	2	1.1	125	157	134	171	NU1022	1	119	116.5	124	128	—	161	—	—	2	1	2.31
	200	38	2.1	2.1	132.5	178.5	241	290	NU222	1	121	121	130	135	144	189	189	182	2	2	4.65
	200	38	2.1	2.1	132.5	180	293	365	NU222R	1	121	121	130	135	144	189	—	—	2	2	4.90
	200	53	2.1	2.1	132.5	178.5	334	442	NU2222	1	121	121	130	135	144	189	—	—	2	2	6.93
	200	53	2.1	2.1	132.5	180.5	384	517	NU2222R	1	121	121	130	135	144	189	—	—	2	2	6.93
	200	69.8	2.1	2.1	132.5	178.5	427	607	NU3222	1	121	121	130	135	—	189	—	—	2	2	9.55
	240	50	3	3	143	207	411	467	NU322	1	123	123	140	145	158	227	227	211	2.5	2.5	10.4
	240	50	3	3	143	211	451	525	NU322R	1	123	123	140	145	158	227	—	—	2.5	2.5	10.7
	240	80	3	3	143	207	604	789	NU2322	1	123	123	140	145	158	227	—	—	2.5	2.5	18.8
	240	80	3	3	143	211	680	880	NU2322R	1	123	123	140	145	158	227	—	—	2.5	2.5	18.8
120	165	27	1.1	1.1	131.5	153.5	116	188	NU2924	1	126.5	126.5	130	134	139	158.5	158.5	156	1	1	1.72
	180	28	2	1.1	135	167	137	181	NU1024	1	129	126.5	134	138	—	171	—	—	2	1	2.47

[Note] 1) For bearings other than NU type bearings (NJ, NUP, N, and NF types), use NJ, NUP, N, and NF for bearing number instead of supplementary code NU. For example, bearing number of a N type bearing having the same dimensions as NU230 is N230.

Single-row cylindrical roller bearings

$d$  (120) ~ (140) mm

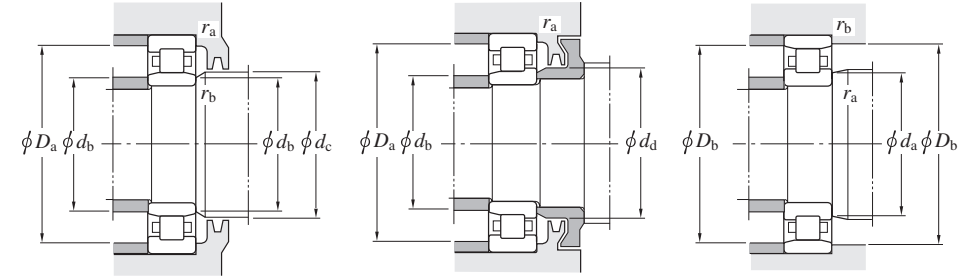
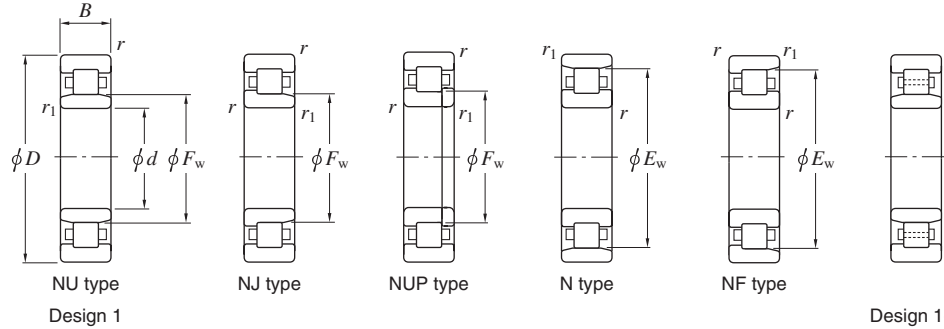

Boundary dimensions (mm)							Basic load ratings (kN)		Bearing No. <sup>1)</sup>	De- sign	Mounting dimensions (mm)									(Refer.) Mass NU (kg)		
$d$	$D$	$B$	$r$ min.	$r_1$ min.	$F_w$	$E_w$	$C_r$	$C_{0r}$	NU		$d_a$ min.	$d_b$ min.	$d_b$ max.	$d_c$ min.	$d_d$ min.	$D_a$ max.	$D_b$ max.	$D_b$ min.	$r_a$ max.	$r_b$ max.		
120	215	40	2.1	2.1	143.5	191.5	260	318	NU224	1	131	131	141	146	156	204	204	196	2	2	5.65	
	215	40	2.1	2.1	143.5	195	336	421	NU224R	1	131	131	141	146	156	204	—	—	2	2	5.85	
	215	58	2.1	2.1	143.5	191.5	367	492	NU2224	1	131	131	141	146	156	204	—	—	2	2	8.56	
	215	58	2.1	2.1	143.5	195.5	452	619	NU2224R	1	131	131	141	146	156	204	—	—	2	2	8.56	
	215	76	2.1	2.1	143.5	191.5	477	695	NU3224	1	131	131	141	146	—	204	—	—	2	2	11.9	
	260	55	3	3	154	226	485	551	NU324	1	133	133	151	156	171	247	247	230	2.5	2.5	13.1	
	260	55	3	3	154	230	528	610	NU324R	1	133	133	151	156	171	247	—	—	2.5	2.5	13.4	
	260	86	3	3	154	226	708	918	NU2324	1	133	133	151	156	171	247	—	—	2.5	2.5	23.1	
	130	180	30	1.5	1.5	142	168	152	243	NU2926	1	138	138	140	145	150	172	172	—	1.5	1.5	2.27
		200	33	2	1.1	148	182	171	238	NU1026	1	139	136.5	146	151	—	191	—	—	2	1	3.77
230		40	3	3	156	204	282	362	NU226	1	143	143	151	158	168	217	217	208	2.5	2.5	6.49	
230		40	3	3	153.5	209	364	453	NU226R	1	143	143	151	158	168	217	—	—	2.5	2.5	6.60	
230		64	3	3	156	204	395	560	NU2226	1	143	143	151	158	168	217	—	—	2.5	2.5	11.2	
230		64	3	3	153.5	209.5	530	737	NU2226R	1	143	143	151	158	168	217	—	—	2.5	2.5	11.2	
230		80	3	3	156	204	550	857	NU3226	1	143	143	151	158	—	217	—	—	2.5	2.5	14.1	
280		58	4	4	167	243	564	667	NU326	1	146	146	164	169	184	264	264	247	3	3	16.4	
280		58	4	4	167	247	616	736	NU326R	1	146	146	164	169	184	264	—	—	3	3	16.7	
280		93	4	4	167	243	838	1 130	NU2326	1	146	146	164	169	184	264	—	—	3	3	29.1	
280		93	4	4	167	247	920	1 230	NU2326R	1	146	146	164	169	186	264	—	—	3	3	29.1	
280		112	4	4	167	243	936	1 290	NU3326	1	146	146	164	169	—	264	—	—	3	3	34.6	
140		190	30	1.5	1.5	152	178	165	275	NU2928	1	148	148	151	155	161	182	182	180	1.5	1.5	2.49
	210	33	2	1.1	158	192	175	250	NU1028	1	149	146.5	156	161	—	201	—	—	2	1	4.00	
	250	42	3	3	169	221	324	421	NU228	1	153	153	166	171	182	237	237	228	2.5	2.5	8.27	
	250	42	3	3	169	225	392	514	NU228R	1	153	153	166	171	182	237	—	—	2.5	2.5	8.50	
	250	68	3	3	169	221	465	671	NU2228	1	153	153	166	171	182	237	—	—	2.5	2.5	14.3	
	250	68	3	3	169	225	572	835	NU2228R	1	153	153	166	171	182	237	—	—	2.5	2.5	14.3	
	300	62	4	4	180	260	623	746	NU328	1	156	156	176	182	198	284	284	264	3	3	21.8	
	300	62	4	4	180	264	663	797	NU328R	1	156	156	176	182	198	284	—	—	3	3	21.8	

[Note] 1) For bearings other than NU type bearings (NJ, NUP, N, and NF types), use NJ, NUP, N, and NF for bearing number instead of supplementary code NU. For example, bearing number of a N type bearing having the same dimensions as NU230 is N230.



Single-row cylindrical roller bearings

d (140) ~ (170) mm

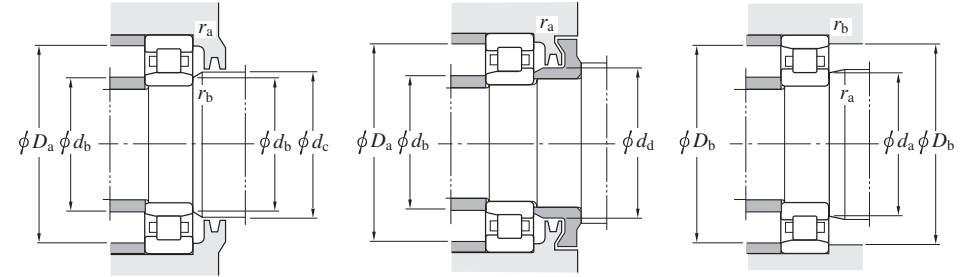
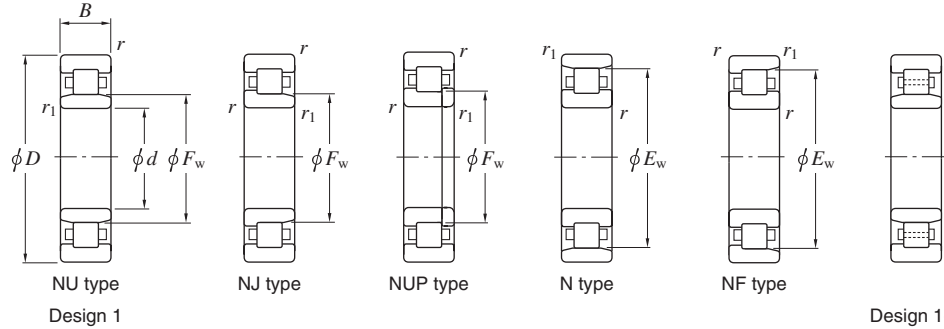

Boundary dimensions (mm)							Basic load ratings (kN)		Bearing No. <sup>1)</sup>	De- sign	Mounting dimensions (mm)										(Refer.) Mass NU (kg)
d	D	B	r min.	r <sub>1</sub> min.	F <sub>w</sub>	E <sub>w</sub>	C <sub>r</sub>	C <sub>0r</sub>	NU		d <sub>a</sub> min.	d <sub>b</sub> min.	d <sub>b</sub> max.	d <sub>c</sub> min.	d <sub>d</sub> min.	D <sub>a</sub> max.	D <sub>b</sub> max.	D <sub>b</sub> min.	r <sub>a</sub> max.	r <sub>b</sub> max.	
140	300	102	4	4	180	260	920	1 250	NU2328	1	156	156	176	182	198	284	—	—	3	3	36.8
	300	102	4	4	180	264	1 020	1 380	NU2328R	1	156	156	176	182	200	284	—	—	3	3	36.8
150	225	35	2.1	1.5	169.5	207.5	201	281	NU1030	1	161	158	167	173	—	214	—	—	2	1.5	4.83
	270	45	3	3	182	238	374	492	NU230	1	163	163	179	184	196	257	257	245	2.5	2.5	10.3
	270	45	3	3	182	242	448	594	NU230R	1	163	163	179	184	196	257	—	—	2.5	2.5	10.7
	270	73	3	3	182	238	545	800	NU2230	1	163	163	179	184	196	257	—	—	2.5	2.5	18.7
	270	73	3	3	182	242	662	982	NU2230R	1	163	163	179	184	196	257	—	—	2.5	2.5	18.7
	320	65	4	4	193	277	663	807	NU330	1	166	166	190	195	213	304	304	281	3	3	26.4
	320	65	4	4	193	283	757	922	NU330R	1	166	166	190	195	213	304	—	—	3	3	27.0
	320	108	4	4	193	277	1 020	1 400	NU2330	1	166	166	190	195	213	304	—	—	3	3	44.7
	320	108	4	4	193	283	1 180	1 600	NU2330R	1	166	166	190	195	213	304	—	—	3	3	44.7
	320	128	4	4	193	277	1 290	1 890	NU3330	1	166	166	190	195	—	304	—	—	3	3	51.4
160	220	28	2	2	175	205	149	228	NU1932	1	169	169	173	178	184	211	211	208	2	2	3.08
	220	36	2	2	175	205	199	330	NU2932	1	169	169	173	178	—	211	211	208	2	2	4.05
	240	38	2.1	1.5	180	222	236	330	NU1032	1	171	168	178	184	—	229	—	—	2	1.5	5.93
	270	86	2.1	2.1	187	243	681	1 070	NU3132	1	171	171	183	190	—	259	259	—	2	2	20.6
	290	48	3	3	195	255	427	568	NU232	1	173	173	192	197	210	277	277	262	2.5	2.5	14.4
	290	48	3	3	195	259	498	666	NU232R	1	173	173	192	197	210	277	—	—	2.5	2.5	14.8
	290	80	3	3	195	255	631	939	NU2232	1	173	173	192	197	210	277	—	—	2.5	2.5	23.6
	290	80	3	3	193	261	809	1 190	NU2232R	1	173	173	192	197	210	277	—	—	2.5	2.5	23.6
	340	68	4	4	208	292	698	876	NU332	1	176	176	200	211	228	324	324	296	3	3	31.7
	340	68	4	4	204	300	857	1 050	NU332R	1	176	176	200	211	228	324	—	—	3	3	32.0
	340	114	4	4	208	292	1 070	1 520	NU2332	1	176	176	200	211	228	324	—	—	3	3	53.1
	340	114	4	4	204	300	1 310	1 820	NU2332R	1	176	176	200	211	228	324	—	—	3	3	53.1
	340	136	4	4	208	292	1 270	1 890	NU3332	1	176	176	200	211	—	324	—	—	3	3	61.5
170	260	42	2.1	2.1	193	237	276	400	NU1034	1	181	181	190	197	—	249	—	—	2	2	7.90
	260	67	2.1	2.1	196	236	461	824	NU3034	1	181	181	193	199	—	249	249	—	2	2	13.0

[Note] 1) For bearings other than NU type bearings (NJ, NUP, N, and NF types), use NJ, NUP, N, and NF for bearing number instead of supplementary code NU. For example, bearing number of a N type bearing having the same dimensions as NU230 is N230.

Single-row cylindrical roller bearings

d (170) ~ (200) mm

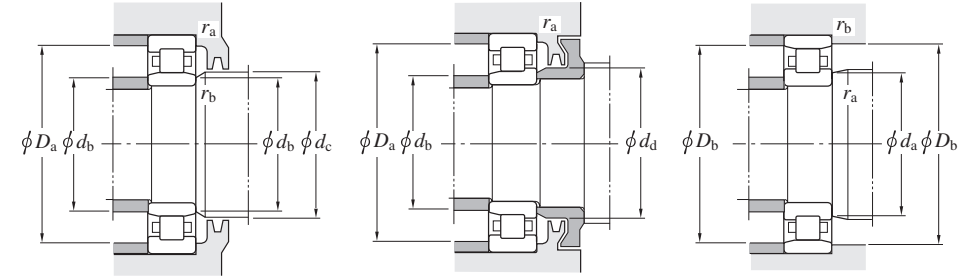
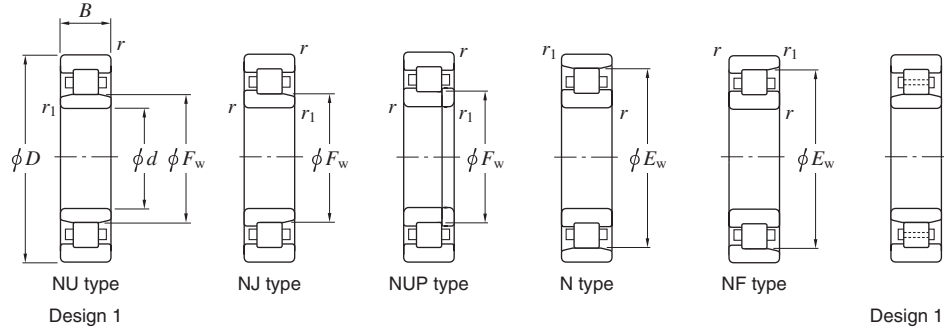

Boundary dimensions (mm)							Basic load ratings (kN)		Bearing No. <sup>1)</sup>	De- sign	Mounting dimensions (mm)								(Refer.) Mass NU (kg)		
d	D	B	r min.	r <sub>1</sub> min.	F <sub>w</sub>	E <sub>w</sub>	C <sub>r</sub>	C <sub>0r</sub>	NU		d <sub>a</sub> min.	d <sub>b</sub> min.	d <sub>b</sub> max.	d <sub>c</sub> min.	d <sub>d</sub> min.	D <sub>a</sub> max.	D <sub>b</sub> max.	D <sub>b</sub> min.	r <sub>a</sub> max.	r <sub>b</sub> max.	
170	310	52	4	4	208	272	475	637	NU234	1	186	186	204	211	223	294	294	280	3	3	18.4
	310	86	4	4	208	272	715	1 080	NU2234	1	186	186	204	211	223	294	—	—	3	3	29.2
	310	86	4	4	205	281	967	1 410	NU2234R	1	186	186	204	211	223	294	—	—	3	3	29.2
	360	72	4	4	220	310	809	1 010	NU334	1	186	186	216	223	241	344	344	314	3	3	38.6
	360	120	4	4	220	310	1 220	1 750	NU2334	1	186	186	216	223	241	344	—	—	3	3	62.6
180	280	46	2.1	2.1	205	257	356	503	NU1036	1	191	191	203	209	—	269	—	—	2	2	10.5
	320	52	4	4	218	282	492	677	NU236	1	196	196	214	221	233	304	304	290	3	3	19.3
	320	52	4	4	217	289	626	852	NU236R	1	196	196	214	221	233	304	—	—	3	3	19.3
	320	86	4	4	218	282	741	1 140	NU2236	1	196	196	214	221	233	304	—	—	3	3	30.4
	320	86	4	4	215	291	1 010	1 510	NU2236R	1	196	196	214	221	233	304	—	—	3	3	30.4
	320	112	4	4	218	282	999	1 680	NU3236	1	196	196	214	221	—	304	—	—	3	3	38.4
	380	75	4	4	232	328	917	1 150	NU336	1	196	196	227	235	255	364	364	332	3	3	42.6
	380	126	4	4	232	328	1 350	1 940	NU2336	1	196	196	227	235	255	364	—	—	3	3	73.0
	380	150	4	4	232	328	1 660	2 520	NU3336	1	196	196	227	235	—	364	—	—	3	3	84.4
190	290	46	2.1	2.1	215	267	366	530	NU1038	1	201	201	213	219	—	279	—	—	2	2	10.9
	340	55	4	4	231	299	554	768	NU238	1	206	206	227	234	247	324	324	310	3	3	23.2
	340	55	4	4	230	306	694	954	NU238R	1	206	206	227	234	247	324	—	—	3	3	23.3
	340	92	4	4	231	299	828	1 290	NU2238	1	206	206	227	234	247	324	—	—	3	3	37.0
	340	120	4	4	231	299	1 310	1 930	NU3238	1	206	206	227	234	—	324	—	—	3	3	46.8
	400	78	5	5	245	345	987	1 260	NU338	1	210	210	240	248	268	380	380	349	4	4	49.9
	400	132	5	5	245	345	1 520	2 220	NU2338	1	210	210	240	248	268	380	—	—	4	4	84.7
	400	155	5	5	245	345	1 870	2 910	NU3338	1	210	210	240	248	—	380	—	—	4	4	96.5
200	310	51	2.1	2.1	229	281	388	582	NU1040	1	211	211	226	233	—	299	—	—	2	2	14.1
	360	58	4	4	244	316	618	865	NU240	1	216	216	240	247	261	344	344	328	3	3	26.8
	360	58	4	4	243	323	766	1 060	NU240R	1	216	216	240	247	261	344	—	—	3	3	27.2
	360	98	4	4	244	316	946	1 490	NU2240	1	216	216	240	247	261	344	—	—	3	3	44.4
	360	98	4	4	241	325	1 220	1 870	NU2240R	1	216	216	240	247	261	344	—	—	3	3	44.4

[Note] 1) For bearings other than NU type bearings (NJ, NUP, N, and NF types), use NJ, NUP, N, and NF for bearing number instead of supplementary code NU. For example, bearing number of a N type bearing having the same dimensions as NU230 is N230.

Single-row cylindrical roller bearings

d (200) ~ (280) mm

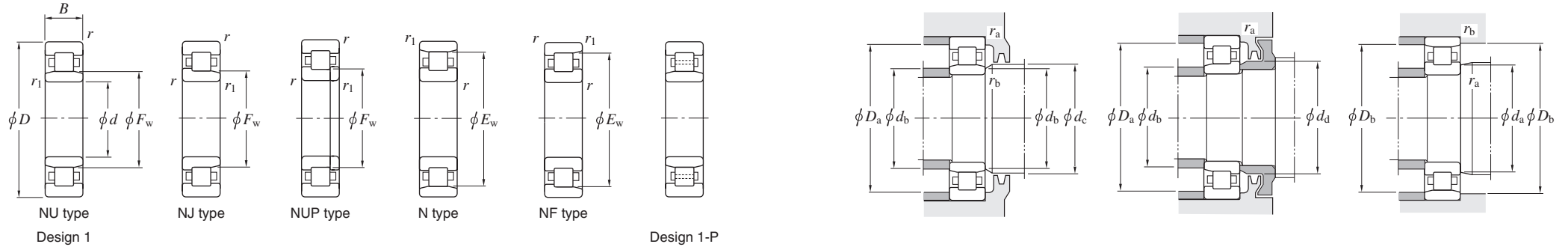

Boundary dimensions (mm)							Basic load ratings (kN)		Bearing No. <sup>1)</sup>	De- sign	Mounting dimensions (mm)									(Refer.) Mass NU (kg)	
d	D	B	r min.	r <sub>1</sub> min.	F <sub>w</sub>	E <sub>w</sub>	C <sub>r</sub>	C <sub>0r</sub>	NU		d <sub>a</sub> min.	d <sub>b</sub> min.	d <sub>b</sub> max.	d <sub>c</sub> min.	d <sub>d</sub> min.	D <sub>a</sub> max.	D <sub>b</sub> max.	D <sub>b</sub> min.	r <sub>a</sub> max.	r <sub>b</sub> max.	
200	420	80	5	5	260	360	987	1 270	NU340	1	220	220	254	263	283	400	400	364	4	4	56.2
	420	138	5	5	260	360	1 520	2 240	NU2340	1	220	220	254	263	283	400	—	—	4	4	97.4
	420	165	5	5	260	360	1 870	2 930	NU3340	1	220	220	250	258	—	400	—	—	4	4	113
220	340	56	3	3	250	312	507	748	NU1044	1	233	233	248	254	—	327	—	—	2.5	2.5	18.5
	370	120	4	4	261	333	1 230	2 140	NU3144	1	236	236	255	264	—	354	354	—	3	3	53.2
	400	65	4	4	270	350	766	1 080	NU244	1	236	236	266	273	289	384	384	362	3	3	38.5
	400	108	4	4	270	355	1 130	1 810	NU2244	1	236	236	266	273	289	384	—	—	3	3	60.9
	400	144	4	4	270	350	1 630	2 880	NU3244	1	236	236	266	273	—	384	—	—	3	3	78.8
	460	88	5	5	284	396	1 200	1 570	NU344	1	240	240	279	287	309	440	440	400	4	4	74.4
	460	145	5	5	284	396	1 810	2 690	NU2344	1	240	240	276	287	—	440	—	—	4	4	119
	460	180	5	5	284	396	2 130	3 300	NU3344	1	240	240	279	287	—	440	—	—	4	4	148
240	360	56	3	3	270	332	535	822	NU1048	1	253	253	268	275	—	347	—	—	2.5	2.5	20.1
	360	92	3	3	276	330	774	1 450	NU3048	1	253	253	270	279	—	347	347	—	2.5	2.5	33.0
	440	72	4	4	295	385	949	1 340	NU248	1	256	256	293	298	316	424	424	397	3	3	52.1
	440	120	4	4	295	385	1 430	2 320	NU2248	1	256	256	293	298	316	424	—	—	3	3	82.5
	440	160	4	4	295	385	1 950	3 460	NU3248	1	256	256	293	298	—	424	—	—	3	3	107
	500	95	5	5	310	430	1 430	1 950	NU348	1	260	260	305	313	337	480	480	434	4	4	94.6
	500	155	5	5	310	430	2 170	3 320	NU2348	1	260	260	303	313	—	480	—	—	4	4	152
	260	360	46	2.1	2.1	285	335	452	777	NU1952	1	271	271	282	288	—	349	349	339	2	2
360		60	2.1	2.1	285	335	558	1 020	NU2952	1	271	271	282	288	—	349	349	339	2	2	18.4
400		65	4	4	296	368	651	979	NU1052	1	276	276	292	300	—	384	—	—	3	3	29.2
480		80	5	5	320	420	1 100	1 580	NU252	1	280	280	318	323	343	460	460	432	4	4	69.0
480		130	5	5	320	420	1 790	2 950	NU2252	1	280	280	318	323	343	460	—	—	4	4	107
480		174	5	5	320	420	2 140	3 680	NU3252	1	280	280	318	323	—	460	—	—	4	4	139
280		350	52	2	2	298	332	427	968	NU3856	1	289	289	295	301	—	341	341	—	2	2
	380	46	2.1	2.1	305	335	406	689	NU1956	1	291	291	302	308	—	369	369	339	2	2	14.7
	420	65	4	4	316	388	669	1 030	NU1056	1	296	296	313	320	—	404	—	—	3	3	35.2

[Note] 1) For bearings other than NU type bearings (NJ, NUP, N, and NF types), use NJ, NUP, N, and NF for bearing number instead of supplementary code NU. For example, bearing number of a N type bearing having the same dimensions as NU230 is N230.

# Single-row cylindrical roller bearings

$d$  (280) ~ 480 mm

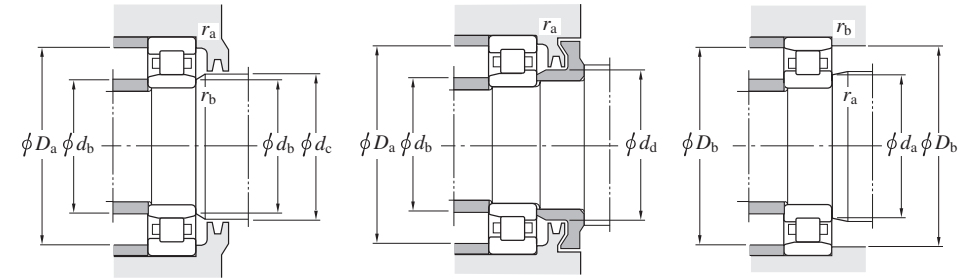
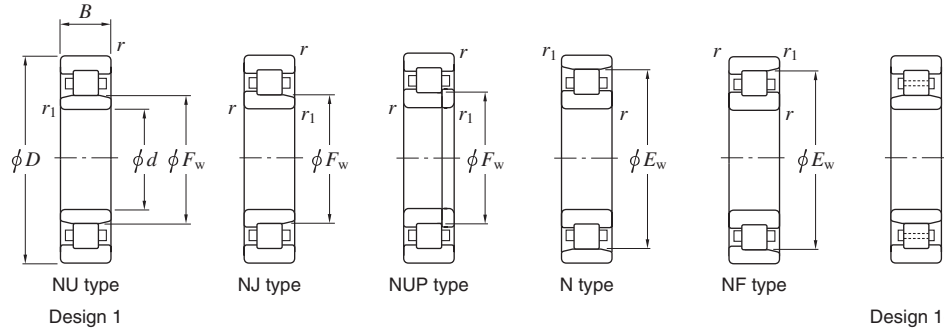

Boundary dimensions (mm)							Basic load ratings (kN)		Bearing No. <sup>1)</sup>	De- sign	Mounting dimensions (mm)									(Refer.) Mass NU (kg)	
$d$	$D$	$B$	$r$ min.	$r_1$ min.	$F_w$	$E_w$	$C_r$	$C_{0r}$	NU		$d_a$ min.	$d_b$ min.	$d_b$ max.	$d_c$ min.	$d_d$ min.	$D_a$ max.	$D_b$ max.	$r_a$ min.	$r_b$ max.	$r_a$ max.	$r_b$ max.
280	500	80	5	5	340	440	1 140	1 680	<b>NU256</b>	1	300	300	336	343	365	480	480	452	4	4	72.7
	380	60	2.1	2.1	322	358	543	1 300	<b>NU3860</b>	1	311	311	319	325	—	369	369	—	2	2	16.6
300	420	56	3	3	332	388	507	873	<b>NU1960</b>	1	313	313	328	335	—	407	407	—	2.5	2.5	23.3
	460	74	4	4	340	424	890	1 380	<b>NU1060</b>	1	316	316	337	344	—	444	—	—	3	3	44.1
	540	85	5	5	364	476	1 350	1 960	<b>NU260</b>	1	320	320	361	368	392	520	520	487	4	4	90.7
320	480	74	4	4	360	444	913	1 450	<b>NU1064</b>	1	336	336	356	365	—	464	—	—	3	3	48.4
	580	92	5	5	390	510	1 540	2 270	<b>NU264</b>	1	340	340	386	393	419	560	560	522	4	4	114
	670	112	7.5	7.5	425	565	1 970	2 880	<b>NU364</b>	1	352	352	419	428	—	638	638	575	6	6	199
340	420	60	2.1	2.1	362	402	624	1 500	<b>NU3868</b>	1	351	351	359	365	—	409	409	—	2	2	18.1
	460	56	3	3	370	430	605	1 080	<b>NU1968</b>	1	353	353	366	373	—	447	447	434	2.5	2.5	25.7
	460	72	3	3	372	428	800	1 620	<b>NU2968</b>	1	353	353	368	375	—	447	447	432	2.5	2.5	34.7
	520	82	5	5	385	477	1 090	1 750	<b>NU1068</b>	1	360	360	381	390	—	500	—	—	4	4	64.1
360	440	38	2.1	2.1	380	420	339	692	<b>NU1872</b>	1	371	371	378	383	—	429	429	424	2	2	11.7
	480	56	3	3	392	448	566	1 060	<b>NU1972</b>	1	373	373	388	395	—	467	467	—	2.5	2.5	27.3
	480	72	3	3	393	447	845	1 820	<b>NU2972</b>	1	373	373	390	396	—	467	467	451	2.5	2.5	37.2
	540	82	5	5	405	497	1 120	1 830	<b>NU1072</b>	1	380	380	401	410	—	520	—	—	4	4	67.1
	540	134	5	5	413	493	1 970	4 180	<b>NU3072</b>	1	380	380	407	416	—	520	520	—	4	4	111
380	480	75	2.1	2.1	405	455	852	1 970	<b>NU3876</b>	1	391	391	401	408	—	469	469	—	2	2	32.3
	560	82	5	5	425	517	1 150	1 920	<b>NU1076</b>	1	400	400	421	430	—	540	—	—	4	4	70.1
400	600	90	5	5	450	554	1 400	2 310	<b>NU1080</b>	1	420	420	446	455	—	580	—	—	4	4	91.0
	600	148	5	5	450	550	2 250	4 370	<b>NU3080</b>	1	420	420	443	453	—	580	580	—	4	4	148
420	620	90	5	5	470	574	1 390	2 320	<b>NU1084</b>	1	440	440	466	475	—	600	—	—	4	4	94.6
460	620	74	4	4	500	580	1 060	1 990	<b>NU1992</b>	1	476	476	495	503	—	604	604	585	3	3	60.8
480	650	78	5	5	525	605	1 130	2 200	<b>NU1996</b>	1	500	500	520	529	—	630	630	—	4	4	72.7

[Note] 1) For bearings other than NU type bearings (NJ, NUP, N, and NF types), use NJ, NUP, N, and NF for bearing number instead of supplementary code NU. For example, bearing number of a N type bearing having the same dimensions as NU230 is N230.

Single-row cylindrical roller bearings

d 500 ~ 850 mm

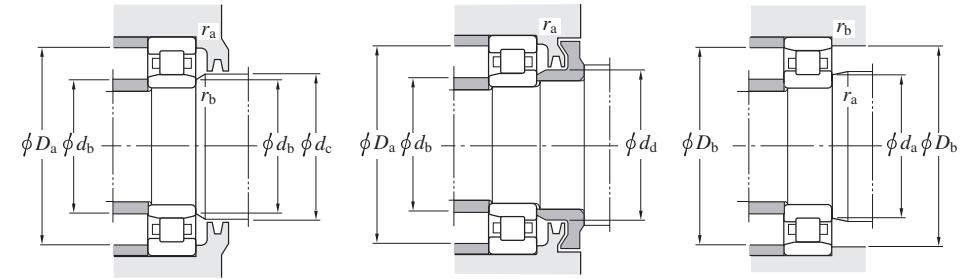
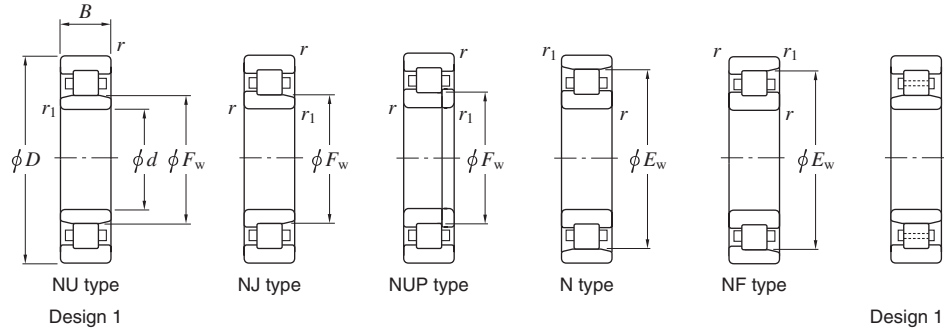

Boundary dimensions (mm)							Basic load ratings (kN)		Bearing No. <sup>1)</sup>	De- sign	Mounting dimensions (mm)									(Refer.) Mass NU (kg)	
d	D	B	r min.	r <sub>1</sub> min.	F <sub>w</sub>	E <sub>w</sub>	C <sub>r</sub>	C <sub>0r</sub>	NU		d <sub>a</sub> min.	d <sub>b</sub> min.	d <sub>b</sub> max.	d <sub>c</sub> min.	d <sub>d</sub> min.	D <sub>a</sub> max.	D <sub>b</sub> max.	r <sub>a</sub> min.	r <sub>a</sub> max.	r <sub>b</sub> max.	
500	620	56	3	3	534	590	705	1 560	NU18/500	1	513	513	531	537	—	607	607	594	2.5	2.5	37.3
	620	90	3	3	534	590	1 210	3 140	NU38/500	1	513	513	530	537	—	607	607	—	2.5	2.5	61.8
	670	78	5	5	546	626	1 480	3 160	NU19/500	1-P	520	520	542	550	—	650	650	—	4	4	78.5
	670	100	5	5	546	626	1 940	4 500	NU29/500	1-P	520	520	542	550	—	650	650	—	4	4	101
	720	100	6	6	556	666	2 270	4 440	NU10/500	1-P	524	524	551	560	—	696	—	674	5	5	141
530	710	82	5	5	575	665	1 320	2 560	NU19/530	1	550	550	570	579	—	690	690	673	4	4	86.9
	710	106	5	5	577	667	2 160	4 850	NU29/530	1-P	550	550	572	561	—	690	690	—	4	4	118
560	750	85	5	5	613	705	1 600	3 260	NU19/560	1	580	580	609	617	—	730	730	—	4	4	105
	750	112	5	5	613	705	2 510	5 870	NU29/560	1	580	580	607	617	—	730	730	—	4	4	140
600	800	90	5	5	652	752	1 980	4 170	NU19/600	1-P	620	620	647	656	—	780	780	—	4	4	126
630	780	88	4	4	671	745	1 510	3 690	NU28/630	1	646	646	665	675	—	764	764	—	3	3	91.8
	850	100	6	6	689	799	2 450	5 240	NU19/630	1-P	654	654	684	693	—	826	826	—	5	5	165
670	820	69	4	4	708	784	1 530	3 750	NU18/670	1-P	686	686	705	712	—	804	804	—	3	3	76.6
850	1 030	106	5	5	900	980	2 120	5 960	NU28/850	1	870	870	894	905	—	1 010	1 010	—	4	4	175
	1 120	118	6	6	917	1 053	3 630	8 190	NU19/850	1-P	874	874	911	921	—	1 096	1 096	1 061	5	5	310

[Note] 1) For bearings other than NU type bearings (NJ, NUP, N, and NF types), use NJ, NUP, N, and NF for bearing number instead of supplementary code NU. For example, bearing number of a N type bearing having the same dimensions as NU230 is N230.

# Double-row cylindrical roller bearings

$d$  100 ~ 200 mm



Boundary dimensions (mm)						Basic load ratings (kN)		Bearing No.		De- sign	Mounting dimensions (mm)						(Refer.) Mass (kg) Cylindrical bore
$d$	$D$	$B$	$r_{\min.}$	$F_w$	$E_w$	$C_r$	$C_{0r}$	NN Cylindrical bore	NNU Cylindrical bore		$d_a$ min.	$d_a$ max.	$d_b$ min.	$d_b$ max.	$D_a$ min.	$D_a$ max.	
100	140	40	1.1	113	—	139	258	—	<b>NNU4920</b>	2	106.5	111	115	133.5	—	1	1.95
	150	37	1.5	—	137	157	265	<b>NN3020</b>	—	1	108	—	—	142	139	1.5	2.28
105	160	41	2	—	146	197	322	<b>NN3021</b>	—	1	114	—	—	151	148	2	2.88
110	150	40	1.1	123	—	163	326	—	<b>NNU4922</b>	2	116.5	121	125	143.5	—	1	2.10
	170	45	2	—	155	221	361	<b>NN3022</b>	—	1	119	—	—	161	157	2	3.65
120	165	45	1.1	134.5	—	187	373	—	<b>NNU4924</b>	2	126.5	132	137	158.5	—	1	2.90
	180	46	2	—	165	232	392	<b>NN3024</b>	—	1	129	—	—	171	167	2	4.00
130	180	50	1.5	146	—	216	428	—	<b>NNU4926</b>	2	138	143.5	148	172	—	1.5	3.90
	200	52	2	—	182	283	476	<b>NN3026</b>	—	1	139	—	—	191	183	2	5.94
140	190	50	1.5	156	—	222	456	—	<b>NNU4928</b>	2	148	153.5	158	182	—	1.5	4.15
	210	53	2	—	192	297	516	<b>NN3028</b>	—	1	149	—	—	201	194	2	6.41
150	210	60	2	168.5	—	343	692	—	<b>NNU4930</b>	2	159	166	171	201	—	2	6.50
	225	56	2.1	—	206	334	587	<b>NN3030</b>	—	1	161	—	—	214	208	2	7.74
160	220	60	2	178.5	—	340	695	—	<b>NNU4932</b>	2	169	176	182	211	—	2	6.95
	240	60	2.1	—	219	398	695	<b>NN3032</b>	—	1	171	—	—	229	221	2	9.38
170	230	60	2	188.5	—	361	763	—	<b>NNU4934</b>	2	179	186	192	221	—	2	7.20
	260	67	2.1	—	236	471	824	<b>NN3034</b>	—	1	181	—	—	249	238	2	12.8
180	225	45	1.1	—	213	228	544	<b>NN4836</b>	—	1	186.5	—	—	218.5	214	1	4.09
	280	74	2.1	—	255	561	958	<b>NN3036</b>	—	1	191	—	—	269	257	2	16.8
190	260	69	2	210	—	465	996	—	<b>NNU4938</b>	2	199	207	215	251	—	2	11.0
	290	75	2.1	—	265	598	1 020	<b>NN3038</b>	—	1	201	—	—	279	267	2	17.6
200	280	80	2.1	223	—	509	1 050	—	<b>NNU4940</b>	2	211	219.5	228	269	—	2	15.4
	310	82	2.1	—	282	638	1 120	<b>NN3040</b>	—	1	211	—	—	299	285	2	22.5
	340	112	3	—	304	960	1 640	<b>NN3140</b>	—	1	213	—	—	327	307	2.5	41.3

[Remark] The bearing number of the tapered bore type bearing is suffixed by K.

# Double-row cylindrical roller bearings

$d$  220 ~ 410 mm



Boundary dimensions (mm)						Basic load ratings (kN)		Bearing No.		De- sign	Mounting dimensions (mm)						(Refer.) Mass (kg) Cylindrical bore
$d$	$D$	$B$	$r_{min.}$	$F_w$	$E_w$	$C_r$	$C_{0r}$	NN Cylindrical bore	NNU Cylindrical bore		$d_a$ min.	$d_a$ max.	$d_b$ min.	$d_b$ max.	$D_a$ min.	$r_a$ max.	
220	300	80	2.1	244	—	561	1 220	—	<b>NNU4944</b>	2	231	241	248	289	—	2	16.7
	370	120	4	263	—	1 110	1 950	—	<b>NNU3144</b>	2	236	260	268	354	—	3	52.5
240	320	80	2.1	263	—	588	1 340	—	<b>NNU4948</b>	2	251	260	269	309	—	2	18.0
	360	92	3	—	330	864	1 590	<b>NN3048</b>	—	1	253	—	—	347	333	2.5	32.8
	400	128	4	286	—	1 270	2 290	—	<b>NNU3148</b>	2	256	282	291	384	—	3	65.3
260	360	100	2.1	287	—	941	2 050	—	<b>NNU4952</b>	2	271	284	296	349	—	2	31.4
280	380	100	2.1	308	—	976	2 200	—	<b>NNU4956</b>	2	291	305	316	369	—	2	33.1
	420	106	4	—	384	1 090	2 010	<b>NN3056</b>	—	1	296	—	—	404	387	3	51.2
300	420	118	3	339	—	1 170	2 720	—	<b>NNU4960</b>	2	313	335	343	407	—	2.5	51.9
	460	118	4	—	418	1 290	2 460	<b>NN3060</b>	—	1	316	—	—	444	421	3	70.8
	500	160	5	—	446	2 060	3 840	<b>NN3160</b>	—	1	320	—	—	480	450	4	126
320	480	121	4	—	438	1 350	2 670	<b>NN3064</b>	—	1	336	—	—	464	442	3	76.4
	480	160	4	362	—	1 970	4 030	—	<b>NNU4064</b>	2	336	358	367	464	—	3	99.9
340	460	118	3	372	—	1 270	2 930	—	<b>NNU4968</b>	2	353	368	383	447	—	2.5	56.8
	520	180	5	387	—	2 370	4 810	—	<b>NNU4068</b>	2	360	383	393	500	—	4	136
360	480	118	3	390	—	1 340	3 050	—	<b>NNU4972</b>	2	373	387	394	467	—	2.5	58.2
	540	134	5	—	493	1 560	3 090	<b>NN3072</b>	—	1	380	—	—	520	497	4	107
	540	180	5	407	—	2 430	5 050	—	<b>NNU4072</b>	2	380	403	413	520	—	4	142
	540	266	5	407	—	3 930	9 410	—	<b>72NNU54266</b>	2-P	380	403	413	520	—	4	219
	600	192	5	—	538	2 820	5 400	<b>NN3172</b>	—	1	380	—	—	580	543	4	218
380	570	300	4	423	—	4 970	11 700	—	<b>76NNU57300</b>	2-P	396	417	425	554	—	3	271
400	600	148	5	—	548	2 030	4 140	<b>NN3080</b>	—	1	420	—	—	580	552	4	146
	600	170	5	452	—	2 930	6 200	—	<b>80NNU60170</b>	2-P	420	447	458	580	—	4	172
	600	200	5	453	—	2 970	6 280	—	<b>NNU4080</b>	2	420	448	459	580	—	4	195
410	600	220	5	470	—	3 700	9 060	—	<b>82DC60220</b>	2-P	430	465	476	580	—	4	214

[Remark] The bearing number of the tapered bore type bearing is suffixed by K.

# Double-row cylindrical roller bearings

$d$  420 ~ (670) mm



Boundary dimensions (mm)						Basic load ratings (kN)		Bearing No.		De- sign	Mounting dimensions (mm)						(Refer.) Mass (kg)
$d$	$D$	$B$	$r_{\min.}$	$F_w$	$E_w$	$C_r$	$C_{0r}$	NN Cylindrical bore	NNU Cylindrical bore		$d_a$ min.	$d_a$ max.	$d_b$ min.	$d_b$ max.	$D_a$ min.	$r_a$ max.	Cylindrical bore
420	560	140	4	460	—	1 670	4 290	—	<b>NNU4984</b>	2	436	457	465	544	—	3	96.7
	600	220	5	470	—	3 700	9 060	—	<b>84DC60220</b>	2-P	440	465	476	580	—	4	204
	620	150	5	—	570	2 310	4 570	<b>NN3084</b>	—	1	440	—	—	600	574	4	154
	620	200	5	473	—	3 050	6 570	—	<b>NNU4084-1</b>	2	440	468	479	600	—	4	203
430	750	280	7.5	515	—	6 040	12 100	—	<b>86DC75280</b>	2-P	462	508	521	718	—	6	539
440	600	160	4	487	—	2 060	5 000	—	<b>NNU4988</b>	2	456	483	492	584	—	3	133
	620	225	4	487	—	3 950	9 980	—	<b>88DC62225</b>	2-P	456	483	492	604	—	3	220
	650	212	6	493	—	3 430	7 530	—	<b>NNU4088A</b>	2	464	488	501	—	5	240	
	650	230	6	495	—	4 030	9 320	—	<b>88NNU65230</b>	2-P	464	489	502	626	—	5	265
460	620	160	4	502	—	2 250	5 440	—	<b>NNU4992</b>	2	476	498	507	604	—	3	136
480	680	280	6	527	—	5 160	12 900	—	<b>96NNU68280</b>	2-P	504	521	531	656	—	5	325
500	670	170	5	545	—	2 940	7 660	—	<b>100DC67170A</b>	2-P	520	541	551	650	—	4	171
	680	210	5	547	—	3 810	9 870	—	<b>100NNU68210</b>	2-P	520	542	552	660	—	4	225
	720	270	8	556	—	4 740	11 400	—	<b>100DC72270A</b>	2-P	532	551	565	688	—	6	353
	720	300	7	556	—	5 580	14 100	—	<b>100DC72300B</b>	2-P	532	551	561	688	—	5.5	405
508	749.3	355.6	6	566	—	7 350	18 300	—	<b>102DC75356</b>	2-P	532	560	573	725	—	5	540
560	735	170	5	604.6	—	3 040	7 730	—	<b>112DC74170</b>	2-P	580	598	609	715	—	4	194
	750	190	5	613	—	3 190	7 940	—	<b>NNU49/560</b>	2	580	608	619	730	—	4	233
600	800	200	5	652	—	3 500	8 630	—	<b>NNU49/600</b>	2	620	647	658	780	—	4	272
	870	200	6	—	801	3 940	8 450	<b>NN30/600</b>	—	1	624	—	—	846	807	5	388
630	780	150	4	671	—	2 430	6 800	—	<b>NNU48/630</b>	2	646	667	676	764	—	3	154
640	890	320	6	705	—	7 330	19 900	—	<b>128DC89320</b>	2-P	664	699	713	866	—	5	625
670	900	230	6	732	—	5 270	14 100	—	<b>NNU49/670</b>	2-P	694	726	740	876	—	5	420

[Remark] The bearing number of the tapered bore type bearing is suffixed by K.



# Double-row cylindrical roller bearings

$d$  (670) ~ 710 mm

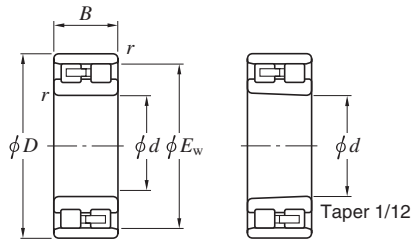

Cylindrical bore

Tapered bore

Design 1 (NN type)

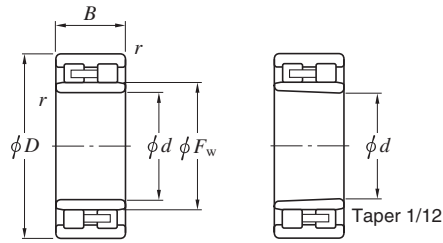

Cylindrical bore

Tapered bore

Design 2 (NNU type)



Design 2-P (NNU type)

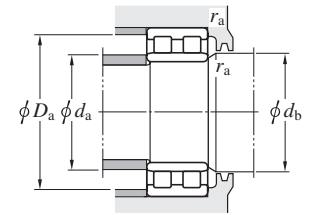
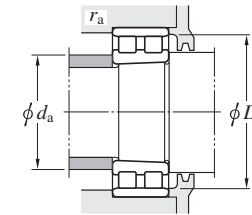

Boundary dimensions (mm)						Basic load ratings (kN)		Bearing No.		De- sign	Mounting dimensions (mm)						(Refer.) Mass (kg) Cylindrical bore
$d$	$D$	$B$	$r_{\min.}$	$F_w$	$E_w$	$C_r$	$C_{0r}$	NN Cylindrical bore	NNU Cylindrical bore		$d_a$ min.	$d_a$ max.	$d_b$ min.	$d_b$ max.	$D_a$ min.	$r_a$ max.	
<b>670</b>	920	330	6	738	—	7 370	20 800	—	<b>134NNU92330</b>	2-P	694	732	746	896	—	5	662
<b>710</b>	950	243	6	775	—	5 890	16 200	—	<b>NNU49/710</b>	2-P	734	769	783	926	—	5	491

[Remark] The bearing number of the tapered bore type bearing is suffixed by K.

# Four-row cylindrical roller bearings

$d$  100 ~ (160) mm

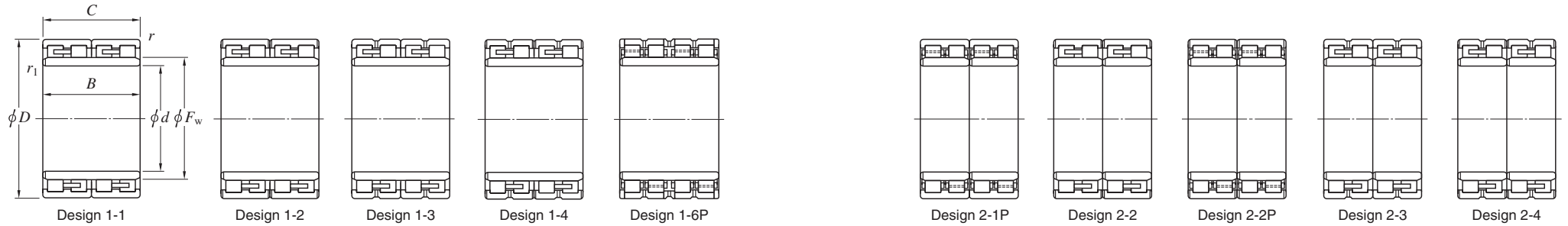

Boundary dimensions (mm)							Basic load ratings (kN)		Bearing No.	Design	Mounting dimensions (mm)					(Refer.) Mass (kg)
$d$	$D$	$B$	$C$	$F_w$	$r_{\min.}$	$r_{1\min.}$	$C_r$	$C_{0r}$			$d_a$ min.	$d_a$ max.	$r_a^{1)}$ min.	$r_a^{1)}$ max.	$r_b^{1)}$ max.	
100	140	120	120	110	1.1	1.1	485	945	20FC14120	2-2	107	133	131	1	1	5.6
	180	120	120	128	2	2	636	971			119	170	164	2	1.5	
110	170	90	90	127	2	2	428	692	22FC1790 22FC18120	1-2	120	160	155	2	2	7.4
	180	120	120	128	2	2	636	971		2-2	119	170	164	2	1.5	
115	165	90	90	132.5	1.1	1.1	398	751	23FC1690	1-1	122	158	154	1	1	6.5
	180	105	105	135	2	1.1	487	796			127	170	165	2	1	
120	165	87	87	134.5	1.1	1.1	374	745	24FC1787 4CR120	1-2	127	158	154	1	1	5.6
	180	105	105	135	2	1.1	487	796		1-2	127	170	165	2	1	
127	174.65	150.812	150.812	139.5	1.1	1.1	630	1 300	25FC17150 25FC20127	2-2	134	167	163	1	1	10.5
	203.2	127	127	147	2	2	740	1 180		1-3	137	193	185	2	2	
130	200	104	104	150	2	2	566	953	26FC20104 26FC20125	1-2	140	190	182	2	2	11.8
	200	125	125	149	2	2	752	1 310		1-2	140	190	183	2	2	
140	190	119	119	154	1.5	1.5	565	1 160	28FC19119W 28FC21116	1-3	149	181	178	1.5	1.5	9.6
	210	116	116	158	2	2	675	1 120		1-2	150	200	194	2	2	
145	210	155	155	166	1.1	1.1	845	1 710	29FC21155 313924	1-2	152	203	196	1	1	17.8
	225	156	156	169	2	2	912	1 680		1-2	155	215	205	2	2	
150	200	120	120	162	2	2	672	1 400	30FC20120	1-2	160	190	188	2	2	10.1
	210	120	120	168.5	2	2	686	1 380	30FC21120	2-2	160	200	196	2	2	12.8
	210	150	150	165	2	2	872	1 780	30FC21150	1-2	160	200	195	2	2	15.9
	220	150	150	170	2	2	887	1 760	30FC22150	1-2	160	210	202	2	2	19.2
	220	150	150	168	2	2	889	1 760	30FC22150A	1-2	160	210	200	2	2	19.5
	230	156	156	174	2	2	961	1 810	313891-1	1-2	160	220	210	2	2	23.8
160	220	180	180	177	2	2	964	2 170	32FC22180	1-2	170	210	205	2	2	20.5
	230	130	130	180	2.1	2.1	867	1 740	314190	1-2	172	218	212	2	2	17.7
	230	168	168	182	1.1	1.1	1 040	2 210	32FC23170	1-2	167	223	214	1	1	22.8
	230	168	168	180	2	2	1 040	2 200	32FC23170A	1-2	170	220	212	2	2	23.1

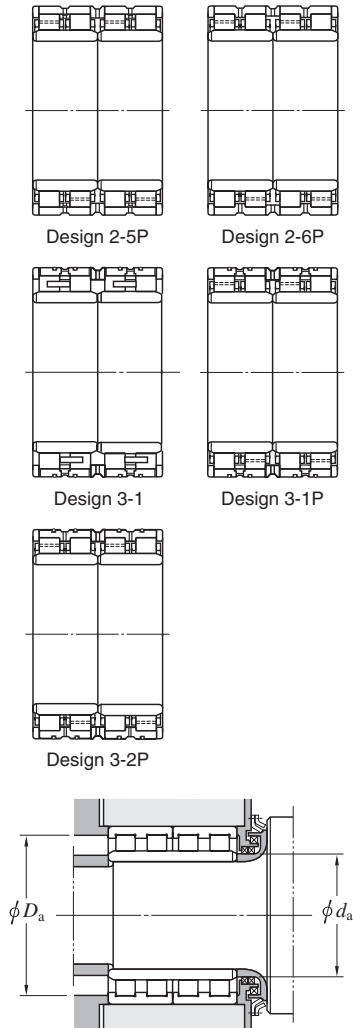

[Note] 1)  $r_a$  indicates housing chamfer dimension corresponding to outer ring chamfer dimension  $r$ .  
 $r_b$  indicates the shaft chamfer dimension corresponding to inner ring chamfer dimension  $r_1$ .

# Four-row cylindrical roller bearings

$d$  (160) ~ (200) mm

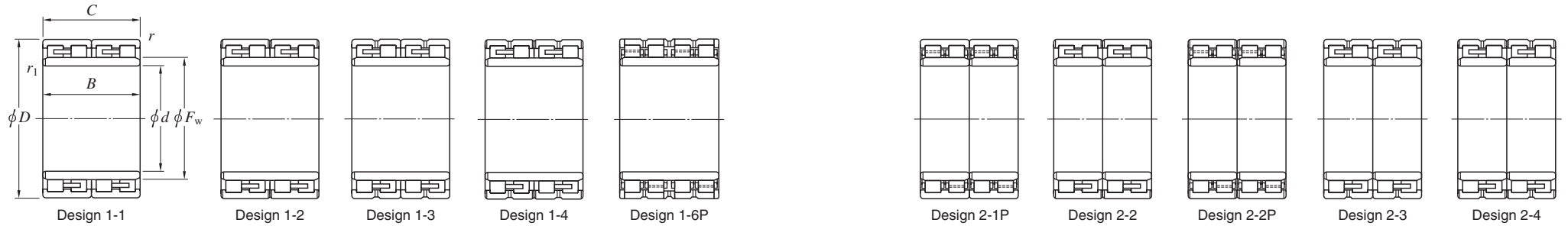

Boundary dimensions (mm)							Basic load ratings (kN)		Bearing No.	Design	Mounting dimensions (mm)					(Refer.) Mass (kg)
$d$	$D$	$B$	$C$	$F_w$	$r_{\min.}$	$r_1_{\min.}$	$C_r$	$C_{0r}$			$d_a$ min.	$D_a$ max.	$r_a$ <sup>1)</sup> min.	$r_a$ <sup>1)</sup> max.	$r_b$ <sup>1)</sup> max.	
160	230	168	168	179	2	2	1 110	2 210	<b>32FC23170B</b>	1-4	170	220	215	2	2	22.6
	230	180	180	177	2	2	1 140	2 270	<b>32FC23180A</b>	1-2	170	220	213	2	2	24.1
	240	120	120	183	2.1	2.1	663	1 140	<b>32FC24120W</b>	1-3	172	228	219	2	2	18.5
	240	170	170	183	2.1	2.1	1 180	2 220	<b>32FC24170</b>	1-2	172	228	223	2	2	26.8
170	230	120	120	187	2	2	782	1 680	<b>34FC23120</b>	1-2	180	220	215	2	2	14.4
	240	156	156	190	2	2	972	2 050	<b>34FC24156A</b>	1-2	180	230	222	2	2	22.4
	240	156	156	189	2	2	1 060	2 100	<b>34FC24156B</b>	1-2	180	230	225	2	2	21.8
	240	190	190	187	1.5	1.5	1 260	2 620	<b>34FC24190</b>	1-2	179	231	223	1.5	1.5	26.9
	250	168	168	192	2.1	2.1	1 170	2 230	<b>34FC25168</b>	1-2	182	238	232	2	2	27.6
	250	170	170	192	2.1	2.1	1 170	2 230	<b>34FC25170</b>	1-2	182	238	232	2	2	27.8
	260	150	150	195	2.1	2.1	1 100	2 000	<b>34FC26150</b>	1-2	182	248	237	2	2	28.8
178	258.75	150	150	199	1.5	1.5	1 090	2 070	<b>36FC26150</b>	1-2	187	250	239	1.5	1.5	25.8
180	250	156	156	200	2	2	1 020	2 130	<b>36FC25156A</b>	1-2	190	240	234	2	2	23.3
	260	168	168	202	2.1	2.1	1 150	2 390	<b>313812W</b>	1-4	192	248	238	2	2	29.7
	260	168	168	202	2.1	2.1	1 230	2 420	<b>36FC26168</b>	1-2	192	248	242	2	2	29.3
	265	180	180	203	2	2	1 300	2 600	<b>36FC27180</b>	1-2	190	255	243	2	2	33.6
190	260	168	168	212	2.1	2.1	1 140	2 600	<b>38FC26168-1</b>	1-2	202	248	244	2	2	26.5
	270	170	170	212	2	2	1 140	2 310	<b>38FC27170</b>	1-2	200	260	250	2	2	30.8
	270	170	170	213	2	2	1 140	2 310	<b>38FC27170A</b>	1-2	200	260	251	2	2	31.0
	270	200	200	212	2	2	1 460	3 080	<b>314199</b>	1-2	200	260	252	2	2	36.1
	280	200	200	214	2.1	2.1	1 550	3 100	<b>38FC28200</b>	1-2	202	268	258	2	2	42
	290	190	190	215	2.1	2.1	1 550	2 860	<b>38FC29190</b>	1-2	202	278	265	2	2	44.9
195	300	226	226	220	2.1	2.1	1 960	3 690	<b>39FC30226</b>	1-2	207	288	274	2	2	57.9
200	270	170	170	222	2	2.1	1 190	2 780	<b>314553</b>	1-2	212	260	254	2	2	28.0
	280	152	152	222	2.1	2.1	1 100	2 150	<b>40FC28152BW</b>	1-3	212	268	262	2	2	28.0

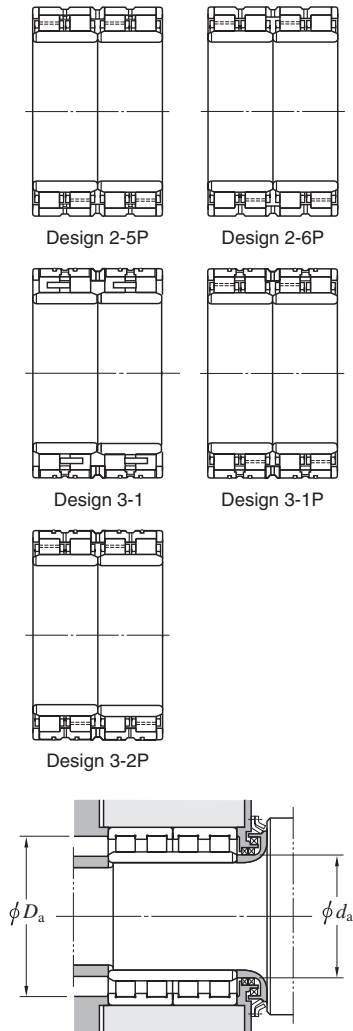

[Note] 1)  $r_a$  indicates housing chamfer dimension corresponding to outer ring chamfer dimension  $r$ .  
 $r_b$  indicates the shaft chamfer dimension corresponding to inner ring chamfer dimension  $r_1$ .

# Four-row cylindrical roller bearings

$d$  (200) ~ (240) mm

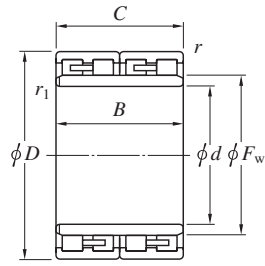

Design 1-1



Design 1-2

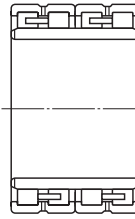

Design 1-3

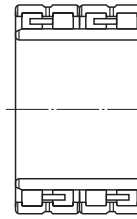

Design 1-4



Design 1-6P



Design 2-1P

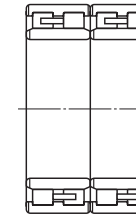

Design 2-2

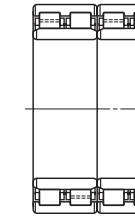

Design 2-2P

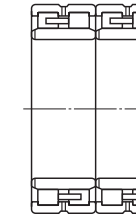

Design 2-3



Design 2-4

Boundary dimensions (mm)							Basic load ratings (kN)		Bearing No.	Design	Mounting dimensions (mm)					(Refer.) Mass (kg)
$d$	$D$	$B$	$C$	$F_w$	$r$ min.	$r_1$ min.	$C_r$	$C_{0r}$			$d_a$ min.	$D_a$ max.	$r_a$ 1) min.	$r_b$ 1) max.	$r_a$ 1) max.	
200	280	170	170	222	2.1	2.1	1 280	2 620	40FC28170	1-2	212	268	262	2	2	31.7
	280	188	188	222	2.1	2.1	1 350	2 810	40FC28188	1-2	212	268	262	2	2	35.0
	280	190	190	223	3	3	1 460	3 100	40FC28190A	1-2	214	266	263	2.5	2.5	36.0
	280	200	200	222	2	2	1 450	3 090	313893-1	1-2	210	270	262	2	2	37.7
	280	200	200	224	2.1	2.1	1 450	3 330	40FC28200	1-2	212	268	260	2	2	38.7
	290	192	192	226	2.1	2.1	1 460	3 030	313811	1-2	212	278	268	2	2	42.0
	310	160	160	232	2.1	2.1	1 260	2 240	40FC31160	1-1	212	298	282	2	2	44.6
	310	206	206	227	2.1	2.1	1 790	3 240	40FC31206	1-2	212	298	283	2	2	56.6
206	299.97	170	170	229	2	2	1 470	2 780	41FC30170	1-2	216	289	277	2	2	39.2
210	290	192	192	236	2.1	2.1	1 460	3 270	42FC29192	1-2	222	278	274	2	2	38.1
	300	210	210	234	2.1	2.1	1 660	3 490	42FC30210	1-2	222	288	278	2	2	47.3
220	300	150	150	240	2.1	2.1	1 210	2 500	44FC30150W	1-3	232	288	280	2	2	30.7
	310	192	192	247	2.1	2.1	1 520	3 270	313837-1	1-2	232	298	289	2	2	45.5
	310	192	192	246	2	2	1 630	3 420	313837A	1-2	230	300	291	2	2	44.9
	310	192	192	245	3	2.1	1 450	2 980	44FC31192W	1-3	232	296	289	2.5	2	43.9
	310	225	225	244	2.1	2.1	1 880	4 160	44FC31225A	1-2	232	298	288	2	2	53.5
	320	210	210	246	2.1	2.1	1 760	3 490	44FC32210	1-2	232	308	296	2	2	55.4
	320	210	210	248	2.1	2.1	1 810	3 740	44FC32210-1	1-4	232	308	296	2	2	56.7
	340	180	180	256	3	3	1 500	2 750	44FC34180A	1-4	234	326	310	2.5	2.5	59.0
230	330	206	206	260	2.1	2.1	1 880	3 980	313824A	1-2	242	318	308	2	2	57.5
	340	260	260	261	3	3	2 310	4 900	46FC34260	1-2	244	326	313	2.5	2.5	81.2
237	339.67	200	200	264	2	2	1 840	3 780	47FC34200	1-2	247	329	314	2	2	58.0
240	330	220	220	270	3	3	1 780	4 250	312943/1YD	1-4	254	316	310	2.5	2.5	55.5
	330	220	220	264	2.1	2.1	1 830	4 120	48FC33220	1-2	252	318	308	2	2	54.3
	330	220	220	268	3	3	1 770	4 070	48FC33220BW	1-4	254	316	310	2.5	2.5	55.5
	330	250	250	263	2.1	2.1	2 160	4 910	48FC33250W	1-3	252	318	309	2	2	63.7

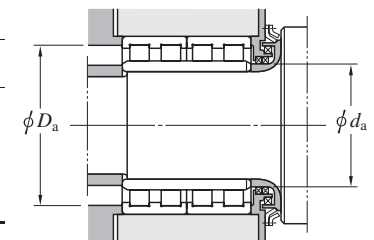
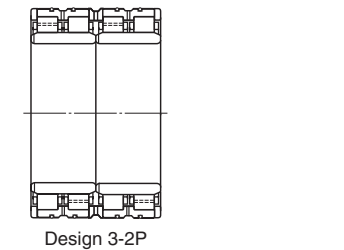
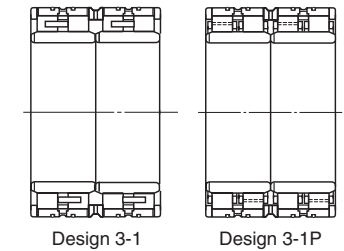
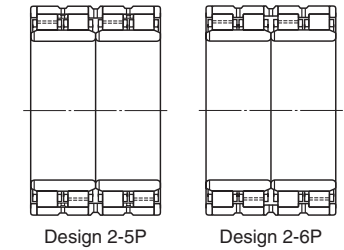

[Note] 1)  $r_a$  indicates housing chamfer dimension corresponding to outer ring chamfer dimension  $r$ .  
 $r_b$  indicates the shaft chamfer dimension corresponding to inner ring chamfer dimension  $r_1$ .

# Four-row cylindrical roller bearings

$d$  (240) ~ (290) mm

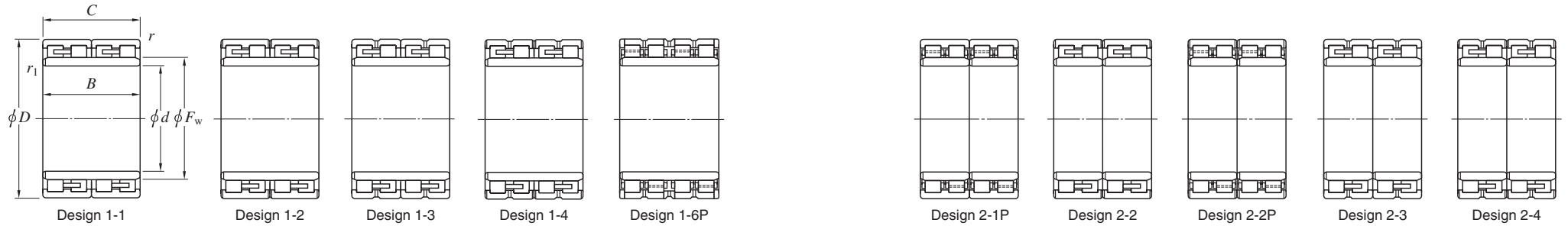

Boundary dimensions (mm)						Basic load ratings (kN)		Bearing No.	Design	Mounting dimensions (mm)					(Refer.) Mass (kg)	
$d$	$D$	$B$	$C$	$F_w$	$r_{\min.}$	$r_1_{\min.}$	$C_r$			$C_{0r}$	$d_a$ min.	$d_a$ max.	$D_a$ min.	$r_a^{1)}$ max.		$r_b^{1)}$ max.
240	340	200	200	266	3	3	1 880	3 780	48FC34200	1-2	254	326	318	2.5	2.5	56.3
	340	220	220	268	3	3	2 000	4 240			48FC34220	254	326	318	2.5	2.5
250	350	220	220	278	3	3	1 930	4 200	50FC35220	1-2	264	336	326	2.5	2.5	64.6
260	355	260	260	286	2.1	2.1	2 290	5 440	52FC35260	2-2	272	343	332	2	2	75.0
	360	192	192	287	2.1	2.1	1 750	3 740	52FC36192W	1-3	272	348	335	2	2	59.8
	360	200	200	287	2.1	2.1	1 880	4 110	52FC36200	1-2	272	348	335	2	2	62.0
	360	230	230	292.5	2.1	2.1	2 140	4 900	52FC36230CW	1-4	272	348	340	2	2	69.7
	360	230	230	292	2.1	2.1	2 020	4 790	52FC36230D	1-2	272	348	336	2	2	72.6
	360	260	260	287	2.1	2.1	2 300	5 320	52FC36260	2-2	272	348	335	2	2	80.0
	368	268	268	288	2.1	2.1	2 740	5 990	52FC37268W	1-4	272	356	344	2	2	89.9
	370	220	220	292	3	3	2 000	4 330	313823	1-2	274	356	342	2.5	2.5	76.0
	370	220	220	290	3	3	2 180	4 480	313823A	1-2	274	356	346	2.5	2.5	75.0
265	370	234	234	292	1.5	1.5	2 290	4 910	53FC37234A	1-2	274	361	346	1.5	1.5	76.3
	370	234	234	300	1.5	1.5	2 270	5 290	53FC37234B	2-2	274	361	348	1.5	1.5	78.5
270	380	230	230	298	2.1	2.1	2 330	4 910	54FC38230	1-2	282	368	354	2	2	80.0
280	380	170	170	306	2.1	2.1	1 710	3 590	56FC38170W	1-3	292	368	356	2	2	55.0
	390	220	220	312	3	3	2 070	4 640	313822	1-2	294	376	362	2.5	2.5	81.8
	390	220	220	308	3	3	2 180	4 670	313822A	1-2	294	376	362	2.5	2.5	79.7
	390	220	220	306	3	2.1	2 520	5 350	313822C	1-2	292	376	364	2.5	2	79.7
	390	220	220	312	3	3	2 320	5 100	313822D	1-2	294	376	366	2.5	2.5	80.1
	390	240	240	312	3	3	2 460	5 620	56FC39240	1-2	294	376	364	2.5	2.5	88.1
	390	275	275	309	2.1	2.1	2 680	6 110	56FC39275B	1-2	292	378	363	2	2	100
	390	275	275	308	3	2.1	3 040	6 850	56FC39275J	2-4	292	376	366	2.5	2	102
	410	300	300	314	3	3	3 730	8 400	56FC41300	2-6P	294	396	378	2.5	2.5	137
	290	390	234	234	320	3	3	2 300	5 500	58FC39234	1-2	304	376	368	2.5	2.5

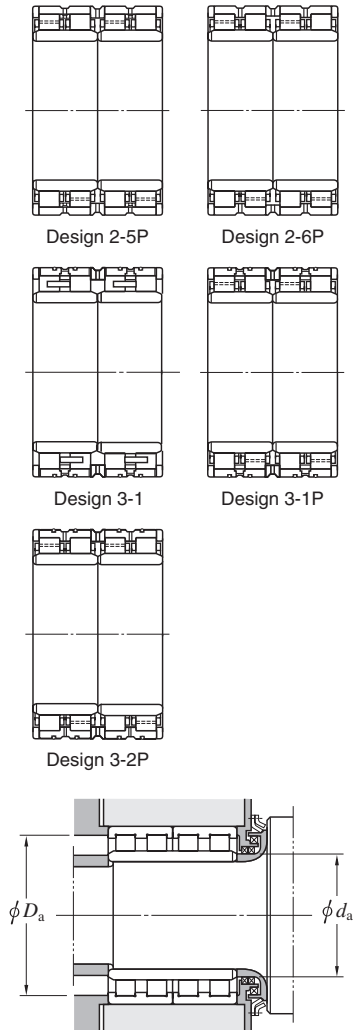

[Note] 1)  $r_a$  indicates housing chamfer dimension corresponding to outer ring chamfer dimension  $r$ .  
 $r_b$  indicates the shaft chamfer dimension corresponding to inner ring chamfer dimension  $r_1$ .

# Four-row cylindrical roller bearings

$d$  (290) ~ (340) mm

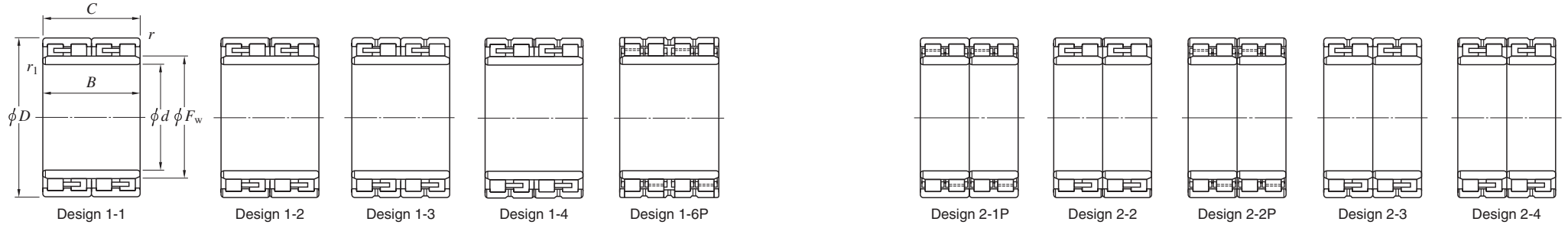

Boundary dimensions (mm)							Basic load ratings (kN)		Bearing No.	Design	Mounting dimensions (mm)					(Refer.) Mass (kg)
$d$	$D$	$B$	$C$	$F_w$	$r_{min.}$	$r_{1 min.}$	$C_r$	$C_{0r}$			$d_a$ min.	$D_a$ max.	$r_a^{1)}$ min.	$r_b^{1)}$ max.	$r_a^{1)}$ max.	
290	400	180	180	320	3	3	1 880	4 010	<b>58FC40180W</b>	1-2	304	386	372	2.5	2.5	68.3
	410	240	240	320	3	3	2 610	5 540	<b>58FC41240</b>	1-2	304	396	380	2.5	2.5	99.0
	420	300	300	327	3	3	3 100	6 960	<b>58FC42300</b>	1-2	304	406	387	2.5	2.5	138
300	400	300	300	328	3	3	2 920	7 310	<b>60FC40300A</b>	1-2	314	386	378	2.5	2.5	103
	420	218	218	332	3	3	2 350	5 010	<b>60FC42218</b>	1-1	314	406	390	2.5	2.5	93.0
	420	240	240	332	3	3	2 660	5 750	<b>60FC42240</b>	1-1	314	406	392	2.5	2.5	102
	420	300	300	332	3	3	3 370	7 840	<b>4CR300</b>	3-2P	314	406	392	2.5	2.5	125
	420	300	300	331	1.5	1.5	3 420	7 750	<b>60FC42300DW</b>	2-4	309	411	395	1.5	1.5	127
	420	300	300	332	2	2	3 750	8 690	<b>60FC42300L-2</b>	2-6P	310	410	395	2	2	129
	420	300	300	332	3	3	3 250	7 270	<b>60FC42300W</b>	2-3	314	406	394	2.5	2.5	127
310	420	300	300	338	3	3	3 090	7 370	<b>62FC42300</b>	1-2	324	406	394	2.5	2.5	119
	430	240	240	344.5	3	3	2 640	5 770	<b>62FC43240</b>	1-2	324	416	404	2.5	2.5	105
	440	240	240	341	3	3	2 820	5 730	<b>62FC44240</b>	1-2	324	426	409	2.5	2.5	113
320	440	230	230	351	3	3	2 530	5 490	<b>64FC44230/240</b>	1-2	334	426	411	2.5	2.5	103
	450	240	240	358	3	3	2 700	5 740	<b>4CR320</b>	1-2	334	436	422	2.5	2.5	119
	450	240	240	355	3	3	2 700	5 730	<b>64FC45240</b>	1-2	334	436	419	2.5	2.5	117
	450	240	240	358	3	3	2 770	5 930	<b>64FC45240CW</b>	1-4	334	436	422	2.5	2.5	118
	460	340	340	360	3	3	3 860	8 730	<b>64FC46340A</b>	1-4	334	446	428	2.5	2.5	187
	480	290	290	361	4	4	4 080	8 450	<b>64FC48290</b>	2-6P	338	462	441	3	3	189
	480	350	350	364	2.1	2.1	5 010	11 000	<b>314274A</b>	2-6P	332	468	444	2	2	227
330	440	200	200	358	3	3	2 340	5 220	<b>66FC44200AW</b>	1-3	344	426	414	2.5	2.5	83.4
	440	200	200	360	3	5	2 050	4 670	<b>66FC44200W</b>	1-3	352	426	412	2.5	4	83.0
	460	340	340	364	2.1	2.1	3 860	9 150	<b>66FC46340</b>	1-2	342	448	428	2	2	172
	460	340	340	368	4	4	4 060	9 800	<b>66FC46340B</b>	1-2	348	442	432	3	3	176
	460	380	380	364	2.1	2.1	4 380	10 800	<b>66FC46380W</b>	1-4	342	448	428	2	2	195
340	445	250	250	367	2.1	4	2 510	6 110	<b>68FC45250W</b>	1-3	358	433	419	2	3	100
	450	250	250	368	2.1	2.1	2 750	6 480	<b>68FC45250BW</b>	1-3	352	438	424	2	2	106

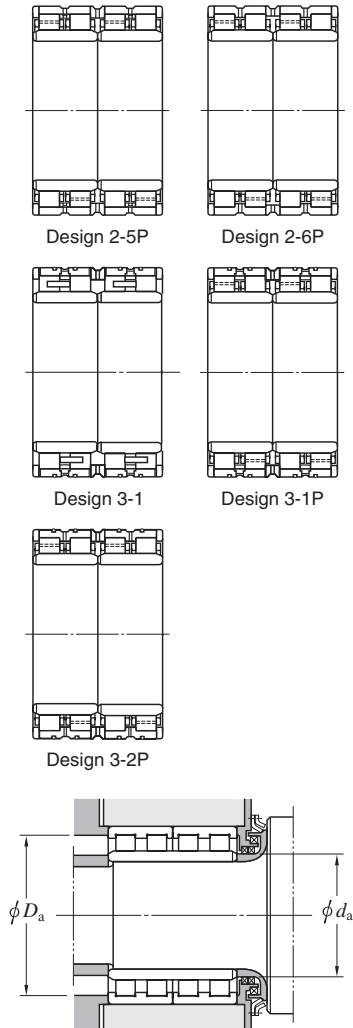

[Note] 1)  $r_a$  indicates housing chamfer dimension corresponding to outer ring chamfer dimension  $r$ .  
 $r_b$  indicates the shaft chamfer dimension corresponding to inner ring chamfer dimension  $r_1$ .

# Four-row cylindrical roller bearings

$d$  (340) ~ 390 mm

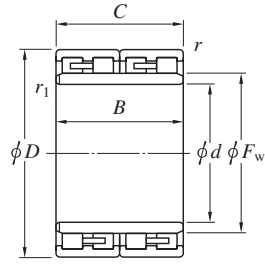

Design 1-1



Design 1-2

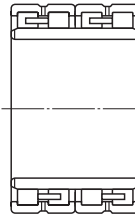

Design 1-3



Design 1-4



Design 1-6P



Design 2-1P

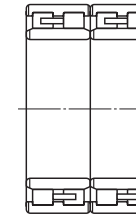

Design 2-2

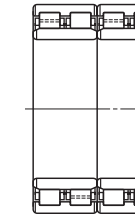

Design 2-2P

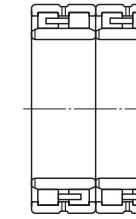

Design 2-3



Design 2-4

Boundary dimensions (mm)							Basic load ratings (kN)		Bearing No.	Design	Mounting dimensions (mm)					(Refer.) Mass (kg)		
$d$	$D$	$B$	$C$	$F_w$	$r_{min.}$	$r_{1 min.}$ <sup>1)</sup>	$C_r$	$C_{0r}$			$d_a$ min.	$D_a$ max.	$r_a$ <sup>2)</sup> min.	$r_a$ <sup>2)</sup> max.	$r_b$ <sup>2)</sup> max.			
340	480	350	350	378	4	SP	4 580	11 100	<b>68FC48350-2</b>	2-4	354	462	446	3	2	211		
	480	350	350	378	3	SP	4 780	11 500			<b>68FC48350D</b>	3-2P	354	466	448	2.5	2	201
	480	350	350	376	4	4	4 840	11 400			<b>68FC48350L</b>	3-2P	358	462	448	3	3	201
	480	385	350	378	2.1	SP	4 780	11 500			<b>68FC48350N</b>	2-6P	358	468	448	2	3	209
	490	300	300	380	5	5	3 500	7 690			<b>68FC49300</b>	1-2	362	468	450	4	4	187
490	300	300	379	5	5	3 680	7 850	<b>68FC49300A</b>	1-2	362	468	453	4	4	182			
<b>343.052</b>	457.098	254	254	374	3	3	2 640	6 190	<b>69FC46254W</b>	1-4	358	443	430	2.5	2.5	112		
<b>350</b>	500	460	460	388	2	2	6 570	16 500	<b>70FC50460</b>	2-6P	360	490	464	2	2	296		
<b>360</b>	480	290	290	392	3	3	3 470	8 510	<b>72FC48290</b>	1-2	374	466	452	2.5	2.5	145		
	500	250	250	394	3	3	3 510	7 340	<b>72FC50250</b>	2-2	374	486	470	2.5	2.5	145		
	510	370	370	400	4	4	4 590	11 000	<b>72FC51370</b>	1-2	378	492	470	3	3	241		
	520	380	380	405	2	5	5 800	13 700	<b>72FC52380</b>	2-6P	382	510	485	2	4	270		
<b>370</b>	520	380	380	409	5	5	5 320	13 200	<b>74FC52380</b>	2-6P	392	498	481	4	4	257		
	520	400	400	413	5	5	4 740	11 900	<b>74FC52400W</b>	2-4	392	498	481	4	4	268		
	540	400	400	415	4	4	5 190	11 500	<b>74FC54400A</b>	1-2	388	522	499	3	3	311		
<b>375</b>	545	400	400	417	4	4	6 310	14 500	<b>75FC55400</b>	3-2P	393	527	505	3	3	315		
<b>380</b>	520	280	280	417	4	4	3 720	8 550	<b>76FC52280</b>	1-2	398	502	487	3	3	173		
	520	290	290	418	4	4	3 760	8 840	<b>76FC52290</b>	1-2	398	502	486	3	3	181		
	540	300	300	421	3	3	4 650	10 100	<b>76FC54300</b>	2-6P	394	526	505	2.5	2.5	222		
	540	340	340	422	4	4	4 600	10 300	<b>76FC54340W</b>	3-1	398	522	502	3	3	256		
	540	360	360	422	4	4	5 480	12 900	<b>76FC54360</b>	2-6P	398	522	502	3	3	266		
	540	400	380	422	4	4	6 010	14 300	<b>76FC54380</b>	2-6P	398	522	504	3	3	287		
	540	400	400	422	4	4	6 040	14 600	<b>76FC54400BW</b>	2-6P	398	522	502	3	3	298		
	540	400	400	422	4	4	6 040	14 600	<b>76FC54400DW</b>	3-2P	398	522	502	3	3	298		
<b>390</b>	550	400	400	434	5	SP	5 130	12 400	<b>78FC55400AW</b>	2-3	410	528	510	4	4	296		

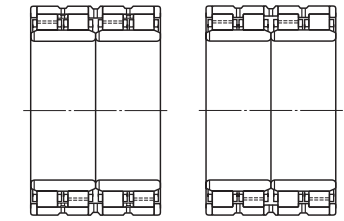

Design 2-5P

Design 2-6P

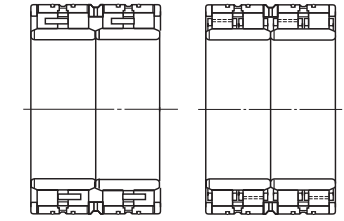

Design 3-1

Design 3-1P

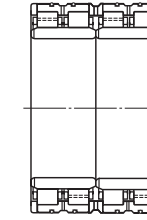

Design 3-2P

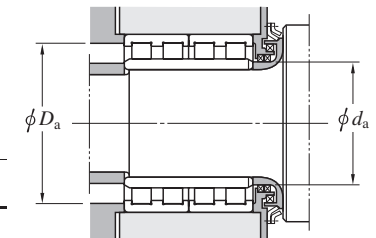

[Notes] 1) SP indicates the specially chamfered form.  
 2)  $r_a$  indicates housing chamfer dimension corresponding to outer ring chamfer dimension  $r$ .  
 $r_b$  indicates the shaft chamfer dimension corresponding to inner ring chamfer dimension  $r_1$ .

# Four-row cylindrical roller bearings

$d$  400 ~ 444.5 mm

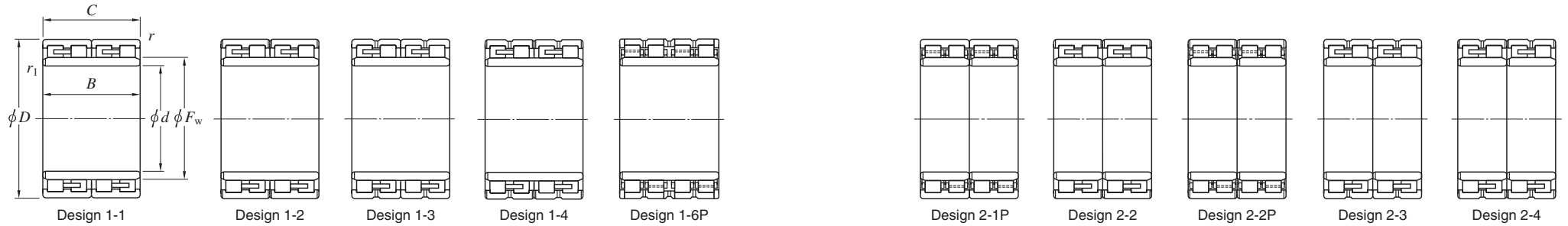

Boundary dimensions (mm)					Basic load ratings (kN)		Bearing No.	Design	Mounting dimensions (mm)					(Refer.) Mass (kg)		
$d$	$D$	$B$	$C$	$F_w$	$r$ min.	$r_1$ min.			$C_r$	$C_{0r}$	$d_a$ min.	$d_a$ max.	$r_a$ 1) min.		$r_a$ 1) max.	$r_b$ 1) max.
400	520	250	250	432	4	4	2 920	7 100	<b>80FC52250W</b>	1-3	418	502	492	3	3	133
	560	360	360	441	5	5	5 570	13 400	<b>80FC56360</b>	2-6P	422	538	521	4	4	277
	560	410	410	445	5	5	6 330	15 800	<b>4CR400</b>	3-2P	422	538	525	4	4	310
	560	410	410	445	2	5	6 470	16 300	<b>80FC56410</b>	2-6P	422	550	525	2	4	315
	600	380	380	450	5	5	6 610	14 300	<b>80FC60380</b>	2-6P	422	578	552	4	4	388
406.4	609.6	304.8	304.8	460	5	5	4 380	8 750	<b>81FC6130W</b>	1-4	429	587	556	4	4	307
410	546	400	400	448	5	5	5 010	13 000	<b>82FC55400</b>	2-2	432	524	516	4	4	256
	600	440	440	460	5	5	8 070	18 800	<b>82FC60440</b>	2-6P	432	578	560	4	4	432
418.5	600	410	410	470	5	5	6 630	15 700	<b>84FC60410A</b>	2-6P	441	578	560	4	4	385
419	592	350	350	462	4	4	5 690	12 900	<b>84FC59350</b>	1-6P	437	574	552	3	3	304
420	560	280	280	457	4	4	3 930	9 410	<b>84FC56280</b>	1-1	438	542	527	3	3	189
	560	400	400	458	4	4	4 870	12 700	<b>84FC56400</b>	2-4	438	542	526	3	3	270
	580	320	320	463	4	4	4 760	11 000	<b>84FC58320</b>	2-4	438	562	543	3	3	249
	600	440	440	470	5	5	7 240	17 700	<b>4CR420A</b>	3-1P	442	578	560	4	4	420
430	591	420	420	472	5	5	6 550	16 800	<b>86FC59420</b>	2-2P	452	569	552	4	4	345
	591	420	420	476	4	4	6 520	17 400	<b>86FC59420-2</b>	2-6P	448	573	552	3	3	349
	591	420	420	476	4	4	5 910	14 700	<b>86FC59420A-1</b>	1-3	448	573	552	3	3	340
	600	450	450	475	5	5	7 460	19 300	<b>86FC60450</b>	2-6P	452	578	559	4	4	405
440	590	270	270	482	4	4	3 620	8 460	<b>88FC59270W</b>	1-3	458	572	554	3	3	207
	620	450	450	487	4	4	7 900	20 000	<b>4CR440</b>	3-1P	458	602	577	3	3	440
	620	450	450	487	4	4	7 900	20 000	<b>88FC62450AW</b>	2-6P	458	602	577	3	3	440
	640	420	420	492	5	5	7 820	18 400	<b>88FC64420</b>	2-6P	462	618	592	4	4	470
	720	452	452	512	6	6	8 570	16 600	<b>88FC72452</b>	1-6P	468	692	652	5	5	740
444.5	660.4	323.85	323.85	500	4	4	6 040	12 600	<b>89FC66324</b>	1-6P	463	642	608	3	3	400

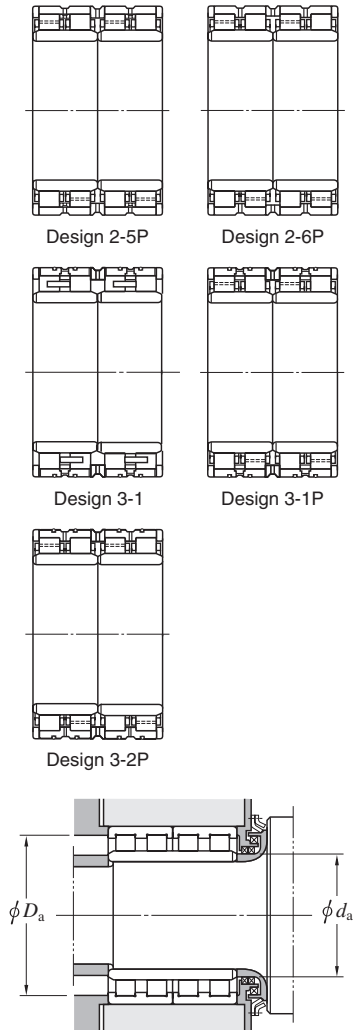

[Note] 1)  $r_a$  indicates housing chamfer dimension corresponding to outer ring chamfer dimension  $r$ .  
 $r_b$  indicates the shaft chamfer dimension corresponding to inner ring chamfer dimension  $r_1$ .



# Four-row cylindrical roller bearings

*d* 445 ~ 500 mm

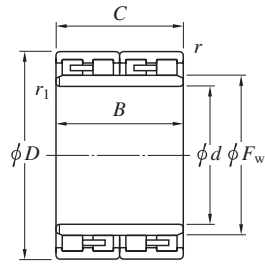

Design 1-1



Design 1-2



Design 1-3



Design 1-4



Design 1-6P



Design 2-1P

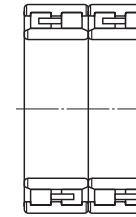

Design 2-2

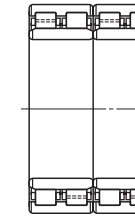

Design 2-2P

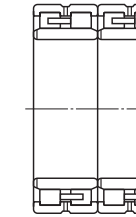

Design 2-3



Design 2-4

Boundary dimensions (mm)					Basic load ratings (kN)		Bearing No.	Design	Mounting dimensions (mm)					(Refer.) Mass (kg)		
<i>d</i>	<i>D</i>	<i>B</i>	<i>C</i>	<i>F<sub>w</sub></i>	<i>r</i> <sup>1)</sup> min.	<i>r</i> <sub>1</sub> <sup>1)</sup> min.			<i>C<sub>r</sub></i>	<i>C<sub>0r</sub></i>	<i>d<sub>a</sub></i> min.	<i>d<sub>a</sub></i> max.	<i>r<sub>a</sub></i> <sup>2)</sup> min.		<i>r<sub>a</sub></i> <sup>2)</sup> max.	<i>r<sub>b</sub></i> <sup>2)</sup> max.
445	635	375	375	496	4	4	6 240	14 600	4CR445	3-1P	463	617	588	3	3	385
450	630	450	450	500	4	4	6 820	16 600	90FC63450A	2-2	468	612	590	3	3	433
460	600	400	400	497	4	SP	5 300	14 300	92FC60400	2-4	478	582	567	3	3	287
	620	400	400	504	4	4	6 850	18 200	4CR460C	3-1P	478	602	584	3	3	350
	620	400	400	502	4	4	6 510	17 000	92FC62400BW	1-6P	478	602	582	3	3	350
	620	400	400	502	4	4	5 900	14 800	92FC62400D	1-4	478	602	583	3	3	340
	650	470	470	509	6	6	8 990	22 200	92FC65470W	1-6P	488	622	609	5	5	494
	660	500	500	512	4	4	9 310	23 300	4CR460	3-1P	478	642	612	3	3	590
	660	500	500	510	5	5	9 540	23 400	92FC66500	2-6P	482	638	614	4	4	573
680	400	400	504	4	4	7 910	16 600	4CR460D	3-1P	478	662	624	3	3	510	
480	650	450	450	525	5	5	8 480	22 400	96FC65450B	2-6P	502	628	615	4	4	440
	650	460	460	526	5	5	7 730	20 800	96FC65460	2-6P	502	628	610	4	4	443
	680	460	460	532	5	5	8 620	21 300	96FC68460	2-6P	502	658	632	4	4	545
	680	500	500	534	5	5	8 620	22 000	4CR480	3-1P	502	658	630	4	4	580
	680	500	500	534	5	5	8 620	22 000	4CR480B	3-2P	502	658	630	4	4	580
	680	500	500	532	5	5	9 550	24 300	96FC68500A	2-6P	502	658	632	4	4	595
495	615	360	360	530	SP	SP	4 030	12 000	99FC62360	2-4	511	597	586	3	3	235
500	670	450	450	540	5	SP	8 460	22 500	100FC67450A-3	2-6P	522	648	630	4	4	451
	680	420	405	550	5	5	6 710	17 600	100FC68405	2-6P	522	658	634	4	4	442
	680	450	450	542.5	4	4	8 980	23 100	100FC68450	2-6P	518	662	639	3	3	495
	690	510	510	550	5	5	9 350	24 600	100FC69510A	3-2P	522	668	646	4	4	562
	710	480	480	558	6	6	9 770	24 800	100FC71480	2-6P	528	682	662	5	5	631
	720	400	400	558	5	6	8 320	18 900	100FC72400	1-6P	528	698	672	4	5	549
	720	530	530	560	6	6	10 800	26 500	100FC72530	2-6P	528	692	674	5	5	725
	720	530	530	568	5	4	11 000	28 900	100FC72530C	2-6P	518	698	672	4	3	742
	720	530	530	560	6	6	10 800	26 500	100FC72530W	3-2P	528	692	674	5	5	725

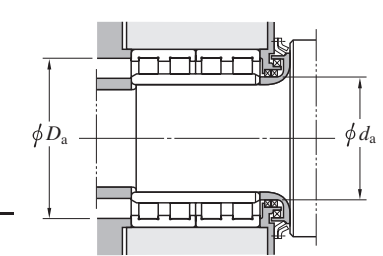
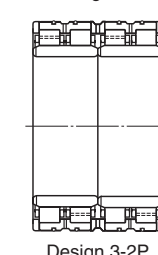
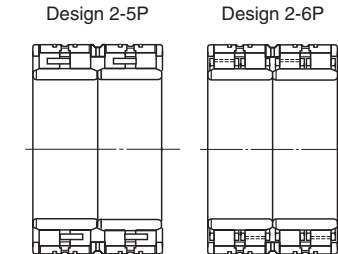
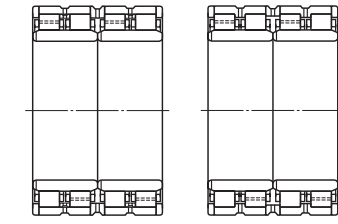

[Notes] 1) SP indicates the specially chamfered form.  
 2) *r<sub>a</sub>* indicates housing chamfer dimension corresponding to outer ring chamfer dimension *r*.  
*r<sub>b</sub>* indicates the shaft chamfer dimension corresponding to inner ring chamfer dimension *r*<sub>1</sub>.

# Four-row cylindrical roller bearings

$d$  510 ~ (600) mm

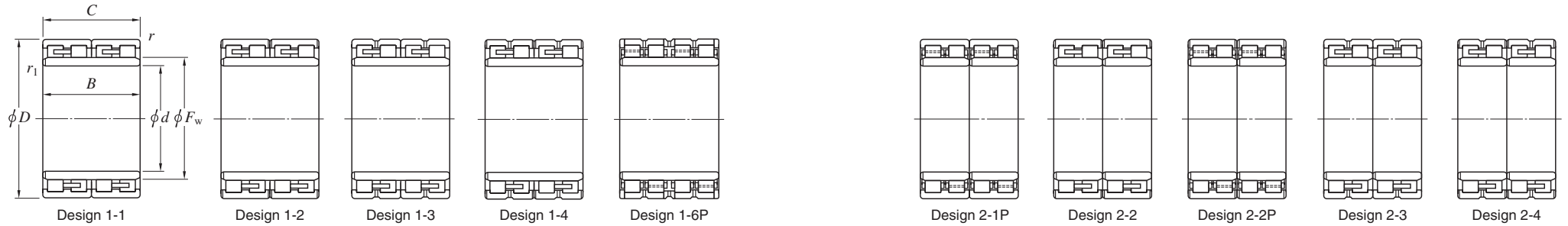

Boundary dimensions (mm)							Basic load ratings (kN)		Bearing No.	Design	Mounting dimensions (mm)					(Refer.) Mass (kg)
$d$	$D$	$B$	$C$	$F_w$	$r_{min.}$	$r_{1 min.}^{1)}$	$C_r$	$C_{0r}$			$d_a$ min.	$d_a$ max.	$r_a^{2)}$ min.	$r_a^{2)}$ max.	$r_b^{2)}$ max.	
510	670	320	320	554	5	5	5 560	14 300	102FC67320 102FC67450	1-6P 2-6P	532	648	634	4	4	305
	670	450	450	550	5	5	8 370	23 400			532	648	634	4	4	433
520	680	450	450	562	5	5	7 810	22 300	104FC68450W 104FC74535 104FC74535C	2-6P 2-5P 3-2P	542	658	642	4	4	435
	735	535	535	574.5	5	5	10 500	27 200			542	713	680	4	4	738
	735	535	535	574.5	5	5	10 700	27 500			542	713	682	4	4	735
530	760	520	520	589	6	SP	11 500	28 800	106FC76520A 106FC78570 106FC78570B	2-6P 2-6P 3-2P	548	732	705	5	2.5	810
	780	570	570	595	6	6	12 500	30 600			558	752	719	5	5	957
	780	570	570	595	6	6	12 500	30 600			558	752	719	5	5	960
536.17	762.03	558.8	558.8	598	5	SP	11 300	29 100	107FC76559AW	2-6P	559	740	710	4	4	825
545	810	580	580	614	6	6	13 100	32 100	4CR545	3-1P	573	782	744	5	5	1 090
550	740	510	510	600	6	6	10 400	28 100	110FC74510	2-6P	578	712	700	5	5	635
560	780	570	570	616	5	2.1	12 400	33 100	112FC78570 112FC80600 112FC82600	2-6P 2-6P 2-6P	572	758	727	4	2	865
	800	600	600	620	7.5	7.5	13 000	33 400			596	764	740	6	6	1 010
	820	600	600	625	6	6	14 600	36 300			588	792	759	5	5	1 120
570	800	514	514	626	6	6	11 700	29 200	114FC80514A 114FC81594	2-6P 2-6P	598	772	746	5	5	829
	815	594	594	628	6	6	13 100	32 100			598	787	758	5	5	1 010
571.1	812.97	594	594	636	6	6	13 400	35 100	114FC81594A	2-6P	600	784	756	5	5	1 030
590	820	590	590	649	6	SP	13 100	35 100	118FC82590	2-6P	621	792	765	5	5	990
600	820	575	575	660	5	5	13 000	36 000	120FC82575B 120FC82575C 120FC85600	2-6P 3-2P 3-2P	622	798	772	4	4	925
	820	575	575	660	5	5	13 000	36 000			622	798	772	4	4	920
	850	600	600	664	4	4	14 600	38 100			618	832	792	3	3	1 120
	870	578	540	672	6	SP	13 300	32 300	120FC87540A 120FC87640 4CR600	2-6P 2-6P 3-1P	628	842	808	5	5	1 120
	870	640	640	672	6	6	15 700	40 000			628	842	808	5	5	1 320
	870	640	640	669	5	5	15 700	40 000			622	848	805	4	4	1 310

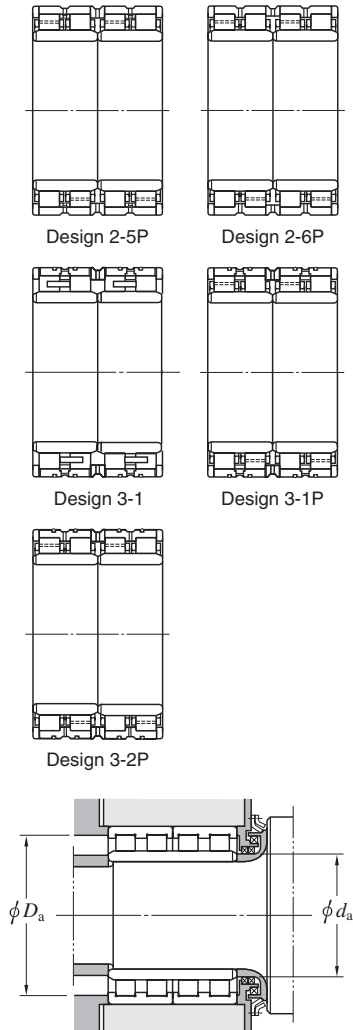

[Notes] 1) SP indicates the specially chamfered form.

2)  $r_a$  indicates housing chamfer dimension corresponding to outer ring chamfer dimension  $r$ .  
 $r_b$  indicates the shaft chamfer dimension corresponding to inner ring chamfer dimension  $r_1$ .

# Four-row cylindrical roller bearings

$d$  (600) ~ 730 mm

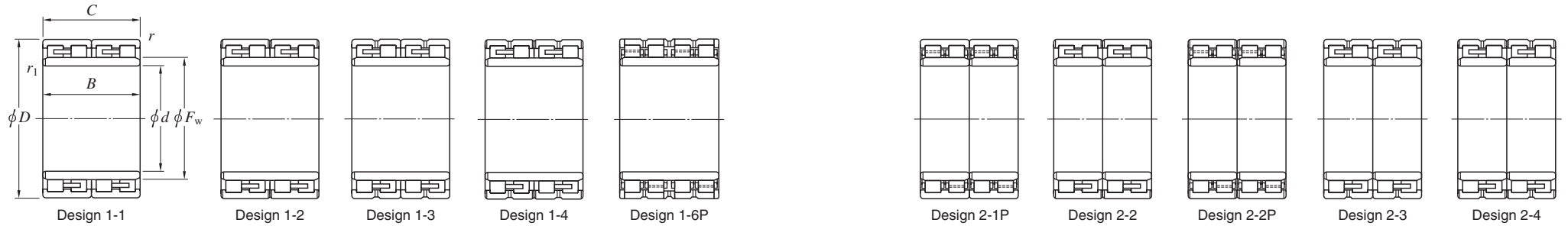

Boundary dimensions (mm)							Basic load ratings (kN)		Bearing No.	Design	Mounting dimensions (mm)					(Refer.) Mass (kg)
$d$	$D$	$B$	$C$	$F_w$	$r_{min.}$	$r_{1(1) min.}$	$C_r$	$C_{0r}$			$d_a$ min.	$d_a$ max.	$r_{a(2) min.}$	$r_{a(2) max.}$	$r_{b(2) max.}$	
600	870	640	640	682	4	4	15 500	40 800	4CR600A 4CR600B	2-6P	618	852	812	3	3	1 330
	870	640	640	669	5	5	15 700	40 000		2-6P	622	848	805	4	4	1 310
610	850	570	570	670	6	6	13 200	34 900	122FC85570 122FC87660	2-6P	638	822	790	5	5	1 040
	870	660	660	680	6	6	15 200	40 300		2-6P	638	842	808	5	5	1 310
630	800	360	360	675	5	5	6 850	19 500	126FC80360	2-6P	652	778	759	4	4	440
640	880	600	600	700	6	6	15 000	40 800	128FC88600	2-5P	668	852	824	5	5	1 130
650	920	670	670	723	7.5	7.5	16 700	45 500	130FC92670 130FC92670A 130FC92690	2-6P	686	884	855	6	6	1 450
	920	670	670	724	7.5	7.5	16 700	45 500		2-6P	686	884	856	6	6	1 480
	920	690	690	724	7.5	7.5	16 700	45 500		2-6P	686	884	856	6	6	1 490
660	820	440	440	708	4	4	7 250	22 700	132FC82440W 132FC89670	2-4	678	802	784	3	3	513
	889.75	670	670	718	6	6	15 700	46 900		2-6P	688	861	830	5	5	1 240
665	968.6	732	732	734.5	6	SP	21 200	53 300	133FC97732	2-6P	693	940	899	5	5	1 870
680	1 020	680	680	775	5	SP	20 000	49 200	4CR680D	3-2P	719	998	946	4	8	2 040
690	980	715	715	767.5	7.5	7.5	18 300	48 800	138FC98715 138FC98750 138FC98750A	2-6P	726	944	911	6	6	1 660
	980	750	750	766	6	7.5	19 300	52 300		3-2P	726	952	910	5	6	1 860
	980	750	750	766	6	7.5	19 300	52 300		2-6P	726	952	910	5	6	1 860
700	980	700	700	774	6	6	17 800	48 200	140FC98700 140FC98700A 140FC98700C 140FC100710W	2-6P	728	952	914	5	5	1 680
	980	700	700	774	6	6	17 800	48 200		3-2P	728	952	914	5	5	1 680
	980	700	700	766	4	4	19 300	51 300		2-6P	718	962	914	3	3	1 710
	1 000	710	710	770	4	4	18 900	47 400		2-6P	718	982	930	3	3	1 810
710	929.9	645	635	767	5	5	15 500	47 000	142FC93635	2-6P	732	907	879	4	4	1 170
730	1 030	750	750	809	6	6	21 600	59 500	146FC103750 146FC105670	2-6P	758	1 002	961	5	5	2 060
	1 050	693	670	804	6	6	20 700	51 200		2-6P	758	1 022	978	5	5	1 980

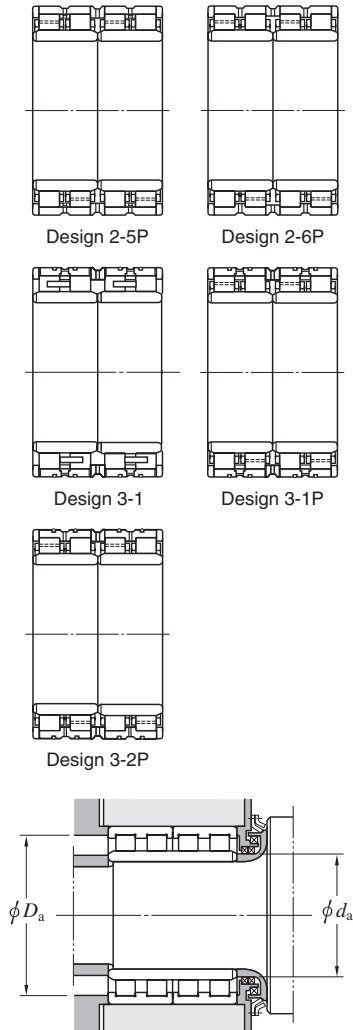

[Notes] 1) SP indicates the specially chamfered form.

2)  $r_a$  indicates housing chamfer dimension corresponding to outer ring chamfer dimension  $r$ .  
 $r_b$  indicates the shaft chamfer dimension corresponding to inner ring chamfer dimension  $r_1$ .

# Four-row cylindrical roller bearings

$d$  750 ~ (850) mm

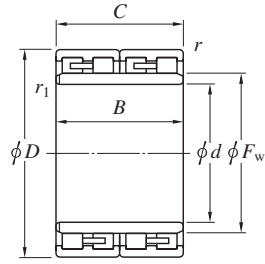

Design 1-1



Design 1-2

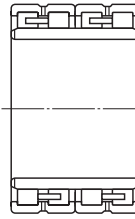

Design 1-3

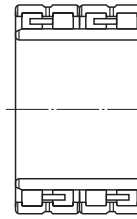

Design 1-4



Design 1-6P



Design 2-1P

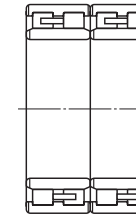

Design 2-2

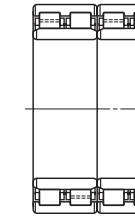

Design 2-2P

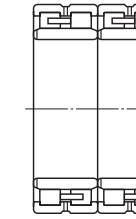

Design 2-3



Design 2-4

Boundary dimensions (mm)							Basic load ratings (kN)		Bearing No.	Design	Mounting dimensions (mm)					(Refer.) Mass (kg)
$d$	$D$	$B$	$C$	$F_w$	$r_{min.}$	$r_{1 min.}$	$C_r$	$C_{0r}$			$d_a$ min.	$d_a$ max.	$r_a^{1)}$ min.	$r_a^{1)}$ max.	$r_b^{1)}$ max.	
750	1 000	670	670	813	6	6	18 300	54 200	150FC100670	2-6P	778	972	941	5	5	1 520
	1 020	630	620	816	6	6	17 600	48 300			150FC102620	778	992	956	5	5
755	1 070	750	750	837	7.5	7.5	22 300	60 300	151FC107750A	3-2P	791	1 034	997	6	6	2 240
760	1 015	700	700	832	7.5	7.5	17 900	54 200	152FC102700	2-5P	796	979	956	6	6	1 590
	1 030	750	750	828	7.5	7.5	20 500	61 100	152FC103750	2-6P	796	994	962	6	6	1 870
	1 079.5	787	787	846	7.5	7.5	22 600	61 700	152FC108787B	2-6P	796	1 043	1 006	6	6	2 380
	1 079.5	787	787	846	7.5	7.5	23 800	65 700	152FC108787D	3-2P	796	1 043	1 006	6	6	2 420
	1 080	805	790	847	6	6	22 600	61 700	4CR760	3-1P	788	1 052	1 007	5	5	2 440
761.425	1 079.602	787.4	787.4	846	7.5	7.5	23 800	65 700	152FC108787C	2-6P	798	1 043	1 006	6	6	2 420
765	1 010	718	708	827	6	6	19 100	58 000	153FC101708A	2-6P	793	982	953	5	5	1 610
	1 065	662	652	840	6	6	19 200	51 700	153FC107652	2-6P	793	1 037	992	5	5	1 870
770	1 075	770	770	847	7.5	6	23 100	63 500	154FC108770	3-2P	798	1 039	1 007	6	5	2 240
	1 075	770	770	847	7.5	6	23 100	63 500	154FC108770A	2-6P	798	1 039	1 007	6	5	2 250
	1 080	650	650	845	6	6	20 100	52 000	154FC108650	2-6P	798	1 052	1 010	5	5	1 930
780	1 070	780	780	852	6	6	22 800	65 100	156FC107780A	2-6P	808	1 042	1 002	5	5	2 140
790	1 015.9	610	610	850	6	6	15 500	48 800	158FC102610	2-6P	818	987	962	5	5	1 290
800	1 080	750	750	880	6	6	18 400	55 000	160FC108750	2-6P	828	1 052	1 010	5	5	2 020
820	1 130	650	650	891	6	6	20 600	53 700	164FC113650	2-6P	848	1 102	1 059	5	5	2 030
	1 130	800	800	903	7.5	7.5	23 400	66 900	164FC113800A	3-2P	856	1 094	1 059	6	6	2 510
	1 130	800	800	903	7.5	7.5	23 400	66 900	164FC113800D	2-6P	856	1 094	1 059	6	6	2 510
840	1 160	840	840	920	7.5	7.5	26 400	76 000	168FC116840B	2-6P	876	1 124	1 084	6	6	2 800
850	1 150	840	840	928	6	6	25 600	77 700	170FC115840	2-6P	878	1 122	1 078	5	5	2 620
	1 180	650	650	945	7.5	7.5	18 700	50 000	170FC118650	2-5P	886	1 144	1 105	6	6	2 190

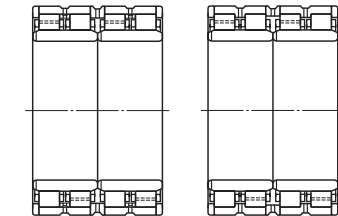

Design 2-5P Design 2-6P

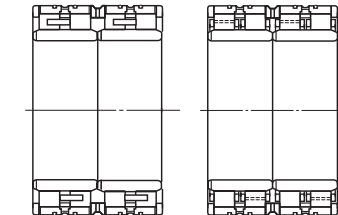

Design 3-1 Design 3-1P

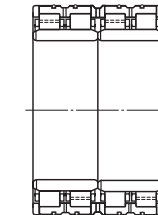

Design 3-2P

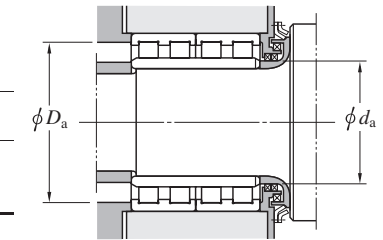

[Note] 1)  $r_a$  indicates housing chamfer dimension corresponding to outer ring chamfer dimension  $r$ .  
 $r_b$  indicates the shaft chamfer dimension corresponding to inner ring chamfer dimension  $r_1$ .

# Four-row cylindrical roller bearings

$d$  (850) ~ 1 000 mm

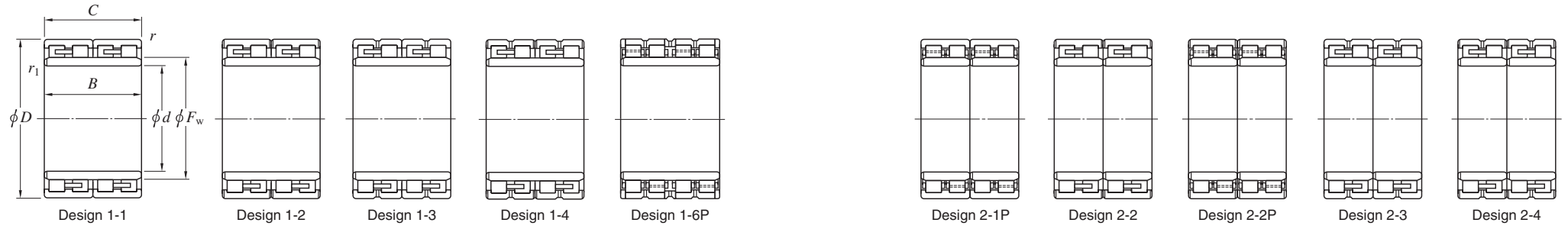

Boundary dimensions (mm)					Basic load ratings (kN)		Bearing No.	Design	Mounting dimensions (mm)					(Refer.) Mass (kg)		
$d$	$D$	$B$	$C$	$F_w$	$r_{min.}$	$r_{1(1) min.}$			$C_r$	$C_{0r}$	$d_a$ min.	$d_a$ max.	$r_a^{(2) min.}$		$r_a^{(2) max.}$	$r_b^{(2) max.}$
850	1 180	850	850	940	7.5	7.5	25 400	72 700	170FC118850	3-2P	886	1 144	1 104	6	6	2 900
	1 180	850	850	940	7.5	7.5	25 400	72 700	170FC118850B	2-6P	886	1 144	1 104	6	6	2 900
	1 180	875	850	940	7.5	7.5	25 400	72 700	4CR850A	3-1P	886	1 144	1 104	6	6	2 930
855	1 094.9	665	655	918	6	6	18 000	58 000	171FC109655	2-6P	883	1 066	1 038	5	5	1 580
	1 178	714	704	928.5	6	6	23 600	62 900	171FC118704	2-6P	883	1 150	1 104	5	5	2 410
860	1 140	750	750	938	7.5	7.5	20 800	63 800	172FC114750	2-6P	896	1 104	1 074	6	6	2 080
	1 160	780	780	932	6	6	24 800	72 600	172FC116780	2-6P	888	1 132	1 088	5	5	2 470
862.98	1 219.302	876.3	889	956	7.5	7.5	29 900	84 600	173FC122889B	2-6P	899	1 183	1 136	6	6	3 450
	1 219.302	889	889	960	7.5	7.5	26 400	74 400	173FC122889	2-6P	899	1 183	1 132	6	6	3 360
870	1 145	705	685	940	6	6	21 500	63 700	174FC115685B	2-6P	898	1 117	1 085	5	5	1 980
	1 181.1	750	750	942	9.5	SP	24 600	68 600	174FC118750	3-2P	906	1 137	1 110	8	6	2 470
880	1 140	800	800	946	6	6	23 600	77 400	176FC114800	2-6P	908	1 112	1 078	5	5	2 210
	1 230	850	850	970	7.5	7.5	29 000	82 100	176FC123850A	2-6P	916	1 194	1 148	6	6	3 280
900	1 220	840	840	981	7.5	7.5	28 000	83 100	180FC122840	2-6P	936	1 184	1 146	6	6	2 980
	1 220	840	840	989	7.5	7.5	27 600	83 300	180FC122840A	2-6P	936	1 184	1 150	6	6	2 980
	1 230	895	870	990	7.5	7.5	26 400	77 500	180FC123870	2-6P	936	1 194	1 154	6	6	3 170
	1 230	895	870	990	7.5	7.5	26 400	77 500	180FC123870A	3-1P	936	1 194	1 154	6	6	3 160
	1 280	930	930	1 000	7.5	7.5	32 100	90 300	180FC128930	2-6P	936	1 244	1 190	6	6	4 050
	1 280	1 050	840	1 000	7.5	7.5	28 900	79 100	180FC128840	1-6P	936	1 244	1 190	6	6	3 890
920	1 280	815	800	1 010	7.5	7.5	28 700	79 900	184FC128800	3-2P	956	1 244	1 196	6	6	3 280
	1 280	865	850	1 015	7.5	7.5	27 600	77 500	4CR920	3-1P	956	1 244	1 195	6	6	3 460
	1 300	975	950	1 019	7.5	7.5	32 600	92 600	4CR920A	3-2P	956	1 264	1 209	6	6	4 180
950	1 300	965	950	1 036	7.5	7.5	32 600	96 900	4CR950A	3-1P	986	1 264	1 216	6	6	3 900
	1 330	950	950	1 053	9.5	9.5	33 300	97 200	190FC133950	2-6P	994	1 286	1 241	8	8	4 330
1 000	1 360	1 025	1 000	1 092	7.5	7.5	36 100	111 000	200FC136100	2-6P	1 036	1 324	1 276	6	6	4 480

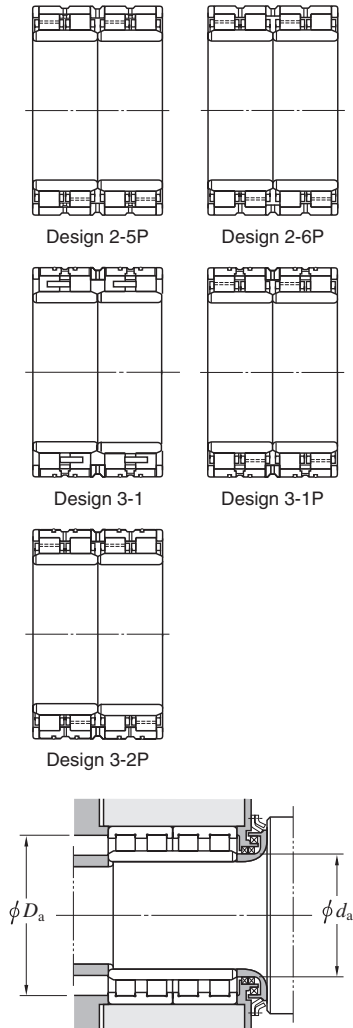

[Notes] 1) SP indicates the specially chamfered form.

2)  $r_a$  indicates housing chamfer dimension corresponding to outer ring chamfer dimension  $r$ .  
 $r_b$  indicates the shaft chamfer dimension corresponding to inner ring chamfer dimension  $r_1$ .

# Four-row cylindrical roller bearings

$d$  1 200 ~ 1 480 mm

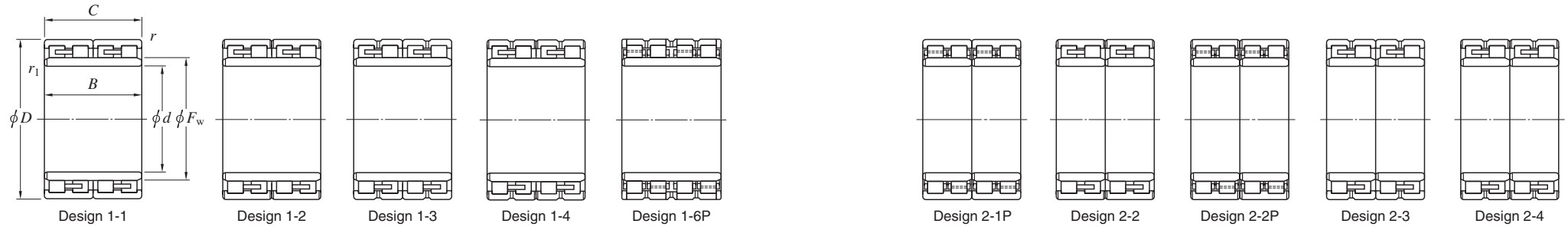

Boundary dimensions (mm)							Basic load ratings (kN)		Bearing No.	Design	Mounting dimensions (mm)					(Refer.) Mass (kg)
$d$	$D$	$B$	$C$	$F_w$	$r_{min.}$	$r_{1 min.}$	$C_r$	$C_{0r}$			$d_a$ min.	$d_a$ max.	$D_a$ min.	$r_a^{1)}$ max.	$r_b^{1)}$ max.	
1 200	1 509.85	1 027.5	1 005	1 278	7.5	7.5	36 600	131 000	<b>240FC151101</b>	2-6P	1 236	1 473	1 438	6	6	4 390
1 270	1 602	850	850	1 354	7.5	7.5	32 800	111 000	<b>254FC160850</b>	2-6P	1 306	1 566	1 524	6	6	4 200
1 300	1 655	890	880	1 391	7.5	7.5	36 000	121 000	<b>260FC165880</b>	2-6P	1 336	1 619	1 571	6	6	4 830
1 349.04	1 745	1 010	1 000	1 446	7.5	7.5	44 200	146 000	<b>270FC175110</b>	2-6P	1 386	1 709	1 651	6	6	6 450
1 480	1 849.74	1 100	1 100	1 574	7.5	7.5	47 500	174 000	<b>296FC185110</b>	2-6P	1 516	1 813	1 764	6	6	7 170

[Note] 1)  $r_a$  indicates housing chamfer dimension corresponding to outer ring chamfer dimension  $r$ .  
 $r_b$  indicates the shaft chamfer dimension corresponding to inner ring chamfer dimension  $r_1$ .

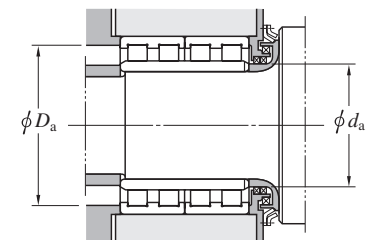
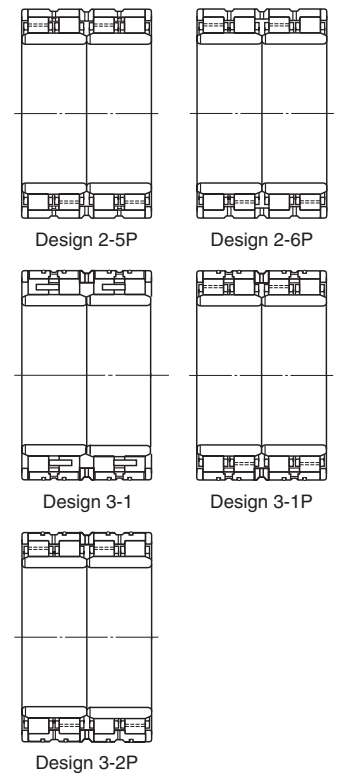

# Four-row cylindrical roller bearings (tapered bore)

$d$  151.5 ~ 855 mm

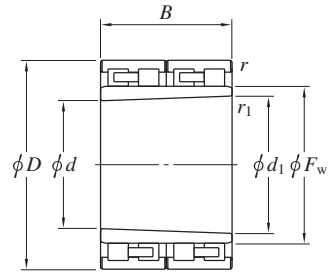

Design 1-1

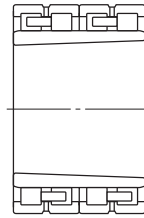

Design 1-2

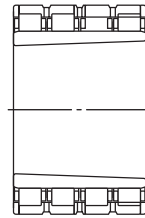

Design 1-3P

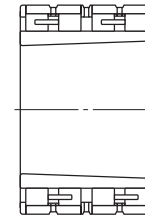

Design 1-4

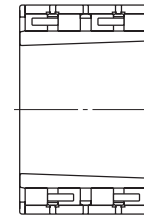

Design 2-2

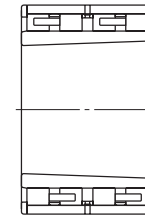

Design 2-3

Boundary dimensions (mm)						Basic load ratings (kN)		Bearing No.	Design	Mounting dimensions (mm)					Mass (kg)	
$d$	$d_1$	$D$	$B$	$F_w$	$r_1^{1)}$ min.	$r_1$ min.	$C_r$			$C_{0r}$	$d_a$ min.	$D_a$ max.	$r_a^{2)}$ min.	$r_b^{2)}$ max.		$r_b^{2)}$ max.
151.5	165.5	230	168	180	2	2	1 040	2 210	<b>32FC23170AK</b>	1-1	176	212	220	2	2	24
181.5	195.5	260	168	209	1.1	1.1	1 120	2 530	<b>314023A</b>	1-1	203	241	253	1	1	27.7
<b>320.833</b>	350	490	350	385	SP	2	4 720	11 100	<b>70FC49350WK</b>	1-2	360	457	480	2	2	226
<b>356.666</b>	389.999	550	400	431.902	2	2	6 010	14 700	<b>71FC55400BK</b>	1-4	400	511	540	2	2	336
<b>358.83</b>	388.83	520	360	422	5	3	4 270	10 900	<b>467412</b>	2-3	407.8	486	501	4	2.5	243
<b>412.5</b>	450	630	450	500	4	4	6 820	16 600	<b>90FC63450KW</b>	1-2	468	590	612	3	3	490
<b>551.667</b>	600	830	580	647	SP	3	12 300	32 200	<b>120FC83580K</b>	2-2	617	763	807	4	2.5	1 060
<b>640.833</b>	700	1 000	710	770	4	4	18 900	47 400	<b>140FC100710K</b>	1-3P	720	930	980	3	3	1 790
<b>650.833</b>	710	1 020	710	785	4	4	19 300	49 100	<b>142FC102710K</b>	1-3P	730	945	1 000	3	3	2 140
<b>855</b>	880	1 180	750	946	9.5	7.5	23 300	66 100	<b>176FC118750AK</b>	1-3P	911	1 106	1 145	8	6	2 480

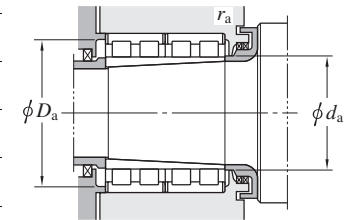

[Notes] 1) SP indicates the specially chamfered form.

2)  $r_a$  indicates housing chamfer dimension corresponding to outer ring chamfer dimension  $r$ .

$r_b$  indicates the shaft chamfer dimension corresponding to inner ring chamfer dimension  $r_1$ .

# Wide series cylindrical roller bearings

■ 99, W99, SW99 series

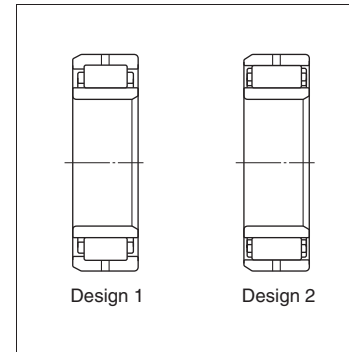

■ D99 series

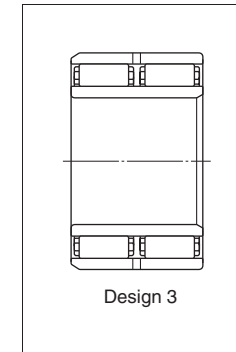

- This type has high radial load capacity, and so, is suited to heavy duty applications or where shock loading is expected.
- Outer ring is available either with or without ribs, either of which is provided with two lubrication holes. Some bearings have four lubrication holes.

■ T99 series ..... For line shaft

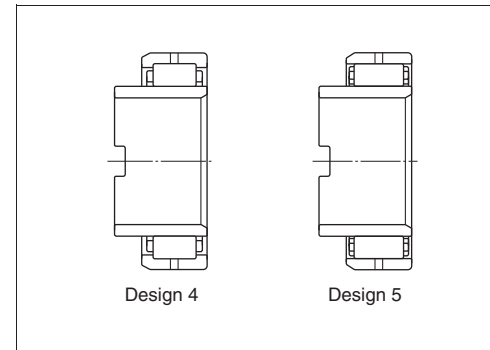

- This is a type equivalent to the above bearing except for extended inner ring provided with a key way.
- Applicable to such applications where large axial movement of the inner ring is involved, and mainly used for line shafts of rolling mill table rollers.

<b>Tolerances</b>	Consult with JTEKT, as bearings are manufactured at special tolerance corresponding to each application of bearing. Tolerances generally correspond to class 0 or class 6 specified in JIS B 1514 (See Table 2-2 given on page 14).
<b>Radial internal clearance</b>	(Refer to Table 4-4 on page 47)
<b>Equivalent radial load</b>	<b>Dynamic equivalent radial load</b> ... $P_r = F_r$ <b>Static equivalent radial load</b> ..... $P_{0r} = F_r$

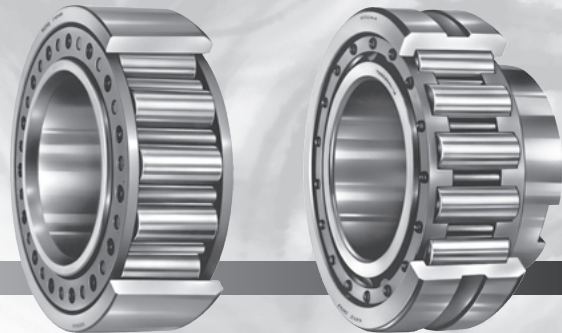



Wide series cylindrical roller bearings

$d$  50 ~ (150) mm

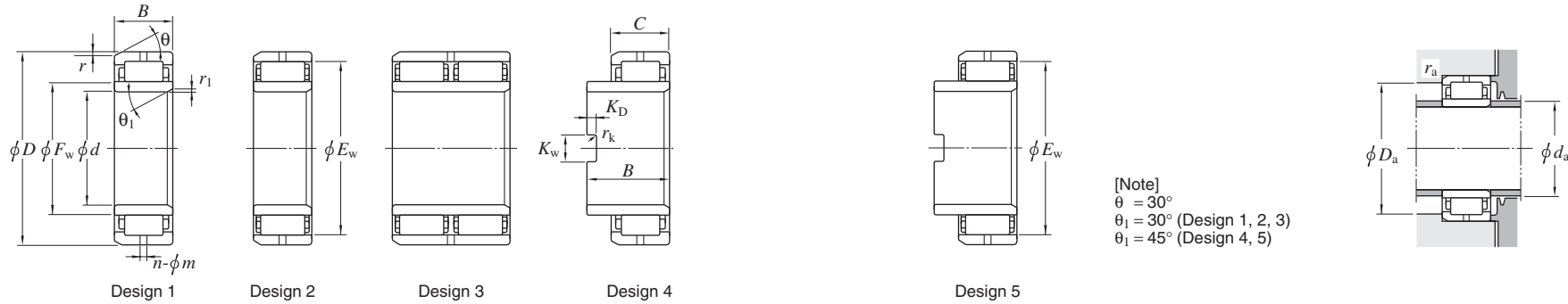

[Note]  
 $\theta = 30^\circ$   
 $\theta_1 = 30^\circ$  (Design 1, 2, 3)  
 $\theta_1 = 45^\circ$  (Design 4, 5)

$d$	Boundary dimensions (mm)							Basic load ratings (kN)		Bearing No.	De-sign	Lubrication hole $n-\phi m$ (qty-mm)	Key way dimensions (mm)			Mounting dimensions (mm)			Mass (kg)
	$D$	$B$	$C$	$F_w$	$E_w$	$r_{min.}$	$r_{1 min.}$	$C_r$	$C_{0r}$				$K_w$	$K_D$	$r_k$	$d_a$ min.	$D_a$ max.	$r_a$ max.	
50	90	44.450	—	60.325	—	2.0	2.0	118	167	W99210NU	1	2-8	—	—	—	58	82	1	1.17
55	100	46.025	—	66.635	89.635	2.0	2.5	129	199	W99211	2	2-8	—	—	—	64	92	1.5	1.64
60	110	49.200	—	73.025	—	2.4	2.4	173	237	W99212NU	1	2-8	—	—	—	69	101	1.5	2.02
70	125	60.325	—	84.138	109.538	2.8	2.8	214	381	W99214	2	2-9.5	—	—	—	80	115	1.5	3.19
75	130	66.675	—	88.881	114.281	2.8	2.8	231	428	W99215	2	2-9.5	—	—	—	85	120	1.5	3.69
80	140	66.675	—	95.250	—	3.2	3.2	278	437	W99216NU	1	2-11.1	—	—	—	91	129	2	4.29
100	180	58.740	—	120	—	4	4	340	483	99220NU	1	2-14	—	—	—	112	168	2.5	6.41
	180	82.550	—	120.650	—	4	4	454	701	W99220NU	1	2-14	—	—	—	112	168	2.5	9.37
101.600	180	110	58.740	120	—	4	3	340	483	T99220NU-1	4	2-14	20	10	1.5	113	167	2	7.59
110	200	65.088	—	133.500	—	R2.1	R2.1	382	579	99222NU	1	2-14	—	—	—	122	188	2	9.07
	200	88.900	—	132.500	—	4	4	531	802	W99222NU	1	2-14	—	—	—	123	187	2.5	11.9
	200	177.800	—	133.350	177.800	4	4	841	1 750	D99222	3	2-14	—	—	—	123	187	2.5	24.6
114.300	200	111.125	88.900	133.350	—	4	3	531	803	TW99222NU	4	2-14	28.97	9.53	2	126	187	2	11.9
125.413	230	117.475	79.375	153.988	—	4.8	3	560	838	T99226NU	4	2-14	25.8	9.53	2	137	215	2	16.4
130	230	79.375	—	153.988	—	4.8	4	560	838	99226NU	1	2-14	—	—	—	143	215	2.5	13.9
	230	107.950	—	153.988	—	4.8	4	706	1 130	W99226NU	1	2-14	—	—	—	143	215	2.5	18.9
138.113	250	130.175	120.650	168.275	—	5.6	3	907	1 540	TXW99228NU	4	2-14	35.32	9.5	2	150	233	2	26.0
140	250	82.550	—	168.275	—	5.6	5.6	632	968	99228NU	1	2-14.3	—	—	—	157	233	3	17.2
	250	82.550	—	168.275	222.251	5.6	5.6	614	1 100	99228	2	2-14.3	—	—	—	157	233	3	17.2
	250	120.650	—	168.275	—	5.6	5.6	907	1 540	W99228NU	1	2-14	—	—	—	157	233	3	25.2
	250	120.650	—	168.275	222.251	5.6	5.6	890	1 770	W99228	2	2-14	—	—	—	157	233	3	25.2
150	270	88.900	—	179.388	—	5.6	5.6	681	1 000	99230NU	1	2-16	—	—	—	167	253	3	21.5

$d$  (150) ~ 200 mm

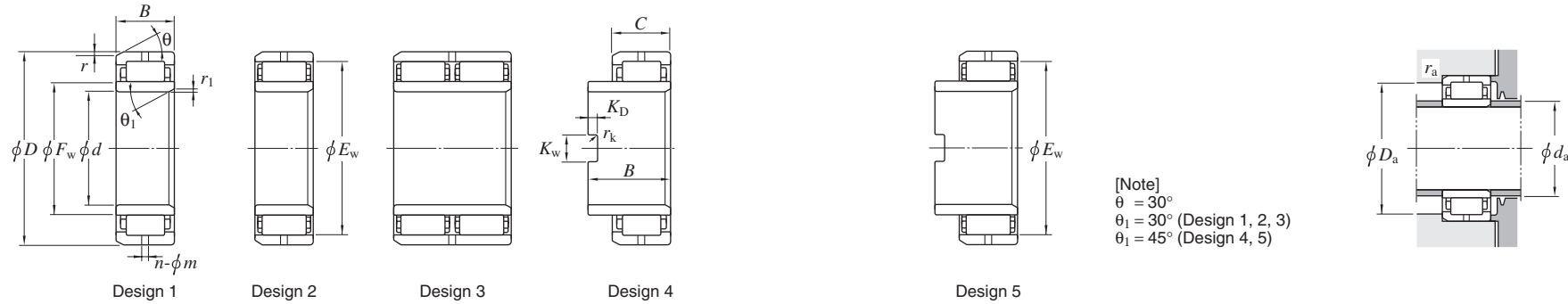

[Note]  
 $\theta = 30^\circ$   
 $\theta_1 = 30^\circ$  (Design 1, 2, 3)  
 $\theta_1 = 45^\circ$  (Design 4, 5)

$d$	Boundary dimensions (mm)							Basic load ratings (kN)		Bearing No.	De-sign	Lubrication hole $n-\phi m$ (qty·mm)	Key way dimensions (mm)			Mounting dimensions (mm)			Mass (kg)
	$D$	$B$	$C$	$F_w$	$E_w$	$r_{\min.}$	$r_{1\min.}$	$C_r$	$C_{0r}$				$K_w$	$K_D$	$r_k$	$d_a$ min.	$D_a$ max.	$r_a$ max.	
150	270	120.650	—	179.388	—	5.6	5.6	860	1 350	<b>W99230NU</b>	1	2-16	—	—	—	167	253	3	29.6
	270	120.650	—	179.388	239.714	5.6	5.6	861	1 600	<b>W99230</b>	2	2-16	—	—	—	167	253	3	29.6
<b>150.813</b>	270	136.525	88.900	179.388	—	5.6	4.06	681	1 000	<b>T99230NU</b>	4	2-16	35.32	11.51	3	164	253	2.5	23.5
160	290	123.825	—	193.675	257.175	6.4	6.4	1 060	2 060	<b>W99232</b>	2	2-16	—	—	—	178	272	4	35.3
	290	247.650	—	193.675	257.175	6.4	6.4	1 750	3 960	<b>D99232</b>	3	2-16	—	—	—	178	272	4	70.6
<b>163.513</b>	290	139.700	123.825	193.675	257.175	6.4	4	1 060	2 060	<b>TW99232</b>	5	2-16	38.497	11.509	2	177	272	2.5	35.6
180	320	149.225	—	215.106	—	6.35	6.35	1 280	2 160	<b>W99236NU</b>	1	2-17.5	—	—	—	198	302	4	50.9
200	340	174.625	—	234.950	—	6.4	6.4	1 670	3 120	<b>SW99240NU</b>	1	4-17.5	—	—	—	218	322	4	64.9

# Full complement cylindrical roller bearings for crane sheaves

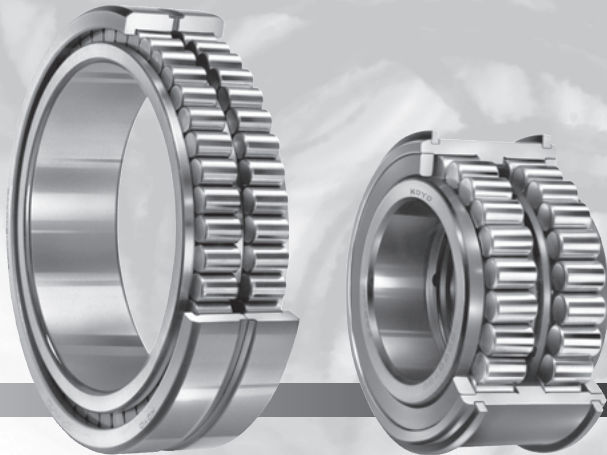

■ Double-row, open type (page 178)

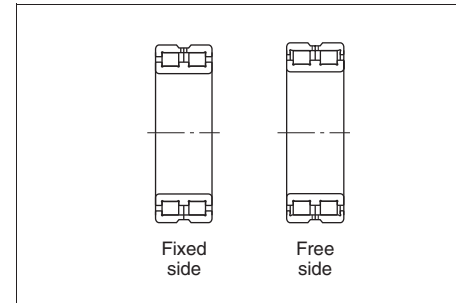

■ Double-row, shielded type (page 182)

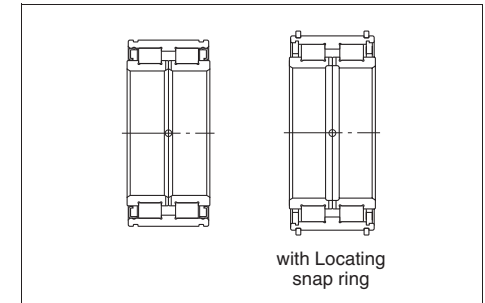

- Since full complement type cylindrical roller bearings can incorporate more rollers than bearings with cage, the load rating can be increased.
- Bearings on the fixed side is capable of withstanding radial load and axial load in both directions.
- The shielded bearing is specially designed for crane sheaves ;
  - Prelubricated with high quality grease.
  - Shield plates are located. (The rubber seal can be employed according to the operating conditions.)
  - The bearing surfaces are coated with phosphate to prevent rusting.

<b>Boundary dimensions</b>	As specified in JIS B 1512.		
<b>Tolerances</b>	As specified in JIS B 1514, class 0 or 6. (refer to Table 2-2 on page 14.)		
<b>Recommended fits and radial internal clearance</b>	<ul style="list-style-type: none"> <li>• Recommended fits: refer to Table 3-3 on pages 35, 36.                             <ul style="list-style-type: none"> <li>■ Fits and clearance of full complement type cylindrical roller bearings for use with crane sheaves with the rotating outer ring load</li> </ul> </li> </ul>		
		Condition	Shaft tolerance class    Housing bore tolerance class
	Rotating outer ring load	Light or fluctuating load Normal or heavy load Heavy load on thin section housing	g 6 or h 6    M 7 N 7 P 7
	Refer to Table 4-4 on page 47. As for the nominal bore dia. up to 140 mm shielded type (DC5000 series), the corresponding CN clearance are shown below.		
	Nominal bore dia. <i>d</i> (mm)		CN clearance (μm)
	over	up to	min.    max.
	30	– 40	35    70
	40	– 50	40    75
	50	– 65	45    90
	65	– 80	55    105
	80	– 100	65    115
	100	– 120	80    120
	120	– 140	90    130
<b>Allowable axial load</b>	The above fixed side bearings whose inner and outer rings have ribs can accommodate a certain magnitude of axial load. As for the equation to calculate allowable axial load in this case, refer to page 119.		
<b>Equivalent radial load</b>	<b>Dynamic equivalent radial load</b> ..... $P_r = F_r$ <b>Static equivalent radial load</b> ..... $P_{0r} = F_r$		

Full complement cylindrical roller bearings for crane sheaves

Double-row, open type

$d$  50 ~ (200) mm

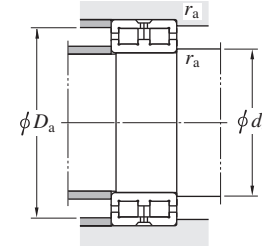
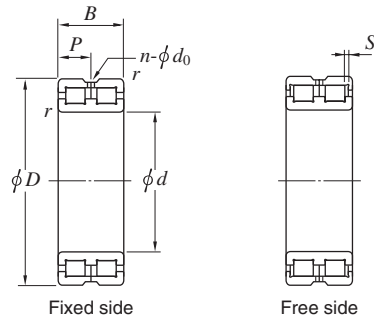

Boundary dimensions (mm)						$S^{1)}$ (mm)	Basic load ratings (kN)		Bearing No.		Lubrication holes (mm)			Mounting dimensions (mm)			Mass (kg)
$d$	$D$	$B$	$B_1$	$B_2$	$r$ min.		$C_r$	$C_{0r}$	Fixed side	Free side	$P$	$n$ qty	$d_0$	$d_a$ min.	$D_a$ max.	$r_a$ max.	
50	72	22	32	42	0.6	1	49.1	82.9	DC4910AVW	DC4910VW	11	4	2	55	67	0.6	0.30
60	85	25	37	49	1	1	72.7	136	DC4912AVW	DC4912VW	12.5	4	2	66	79	1	0.46
70	100	30	44	57	1	1	105	193	DC4914AVW	DC4914VW	15	4	2	76	94	1	0.78
80	110	30	44	57	1	1	114	218	DC4916AVW	DC4916VW	15	4	2	86	104	1	0.88
90	125	35	52	68	1.1	1.5	150	301	DC4918AVW	DC4918VW	17.5	4	2.5	97	118	1	1.35
100	140	40	59	78	1.1	2	194	400	DC4920AVW	DC4920VW	20	4	2.5	107	133	1	1.95
110	150	40	59	78	1.1	2	202	431	DC4922AVW	DC4922VW	20	4	2.5	117	143	1	2.15
120	165	45	66	87	1.1	3	226	479	DC4924AVW	DC4924VW	22.5	4	3	127	158	1	2.95
130	180	50	73	96	1.5	4	276	560	DC4926AVW	DC4926VW	25	4	3	138.5	171.5	1.5	3.95
140	190	50	73	96	1.5	4	284	589	DC4928AVW	DC4928VW	25	4	3	148.5	181.5	1.5	4.20
150	190	40	—	—	1.1	2	234	575	DC4830AVW	DC4830VW	20	4	3	157	183	1	2.90
	210	60	88	116	2	4	406	842	DC4930AVW	DC4930VW	30	6	4	160	200	2	6.65
160	200	40	—	—	1.1	2	242	616	DC4832AVW	DC4832VW	20	4	3	167	193	1	3.05
	220	60	88	116	2	4	428	895	DC4932AVW	DC4932VW	30	6	4	170	210	2	7.00
170	215	45	—	—	1.1	3	269	655	DC4834AVW	DC4834VW	22.5	4	3	177	208	1	4.10
	230	60	88	116	2	4	440	944	DC4934AVW	DC4934VW	30	6	4	180	220	2	7.35
180	225	45	—	—	1.1	3	276	690	DC4836AVW	DC4836VW	22.5	4	4	187	218	1	4.30
	250	69	101	133	2	4	547	1 140	DC4936AVW	DC4936VW	34.5	6	4	190	240	2	10.7
190	240	50	—	—	1.5	4	327	782	DC4838AVW	DC4838VW	25	4	4	198.5	231.5	1.5	5.65
	260	69	101	133	2	4	555	1 200	DC4938AVW	DC4938VW	34.5	6	5	200	250	2	11.2
200	250	50	—	—	1.5	4	337	826	DC4840AVW	DC4840VW	25	4	4	208.5	241.5	1.5	5.90

[Note] 1) Effective movement of the bearing on the free side in an axial direction.

Double-row, open type

$d$  (200) ~ 440 mm

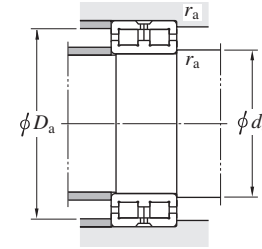
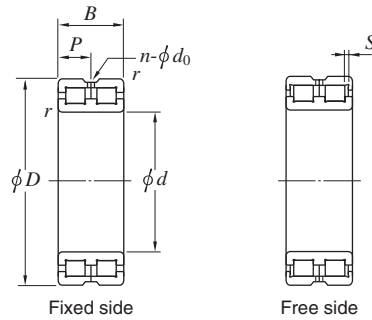

Boundary dimensions (mm)						$S^{1)}$ (mm)	Basic load ratings (kN)		Bearing No.		Lubrication holes (mm)			Mounting dimensions (mm)			Mass (kg)
$d$	$D$	$B$	$B_1$	$B_2$	$r_{min.}$		$C_r$	$C_{0r}$	Fixed side	Free side	$P$	$n$ qty	$d_0$	$d_a$ min.	$D_a$ max.	$r_a$ max.	
200	280	80	116	152	2.1	5	667	1 500	DC4940AVW	DC4940VW	40	6	6	212	268	2	15.7
220	270	50	—	—	1.5	4	355	971	DC4844AVW	DC4844VW	25	6	4	228.5	261.5	1.5	6.40
	300	80	116	152	2.1												
240	300	60	—	—	2	4	509	1 330	DC4848AVW	DC4848VW	30	6	5	250	290	2	10.2
	320	80	116	152	2.1												
260	320	60	—	—	2	4	532	1 450	DC4852AVW	DC4852VW	30	6	5	270	310	2	11.0
	360	100	146	192	2.1												
280	350	69	—	—	2	4	663	1 720	DC4856AVW	DC4856VW	34.5	6	5	290	340	2	16.0
	380	100	146	192	2.1												
300	380	80	—	—	2.1	6	802	2 160	DC4860AVW	DC4860VW	40	8	6	312	368	2	23.0
	420	118	174	230	3												
320	400	80	—	—	2.1	6	832	2 310	DC4864AVW	DC4864VW	40	8	6	332	388	2	24.3
	440	118	174	230	3												
340	420	80	—	—	2.1	6	853	2 430	DC4868AVW	DC4868VW	40	8	6	352	408	2	25.6
	460	118	174	230	3												
360	440	80	—	—	2.1	6	880	2 580	DC4872AVW	DC4872VW	40	8	6	372	428	2	27.0
	480	118	174	230	3												
380	480	100	—	—	2.1	6	1 310	3 570	DC4876AVW	DC4876VW	50	8	6	392	468	2	45.3
	520	140	206	272	4												
400	540	140	206	272	4	7	2 380	5 990	DC4980AVW	DC4980VW	70	8	8	418	522	3	96.4
420	560	140	206	272	4	7	2 440	6 270	DC4984AVW	DC4984VW	70	8	8	438	542	3	101
440	600	160	236	312	4	7	2 970	7 390	DC4988AVW	DC4988VW	80	8	8	458	582	3	139

[Note] 1) Effective movement of the bearing on the free side in an axial direction.

Full complement cylindrical roller bearings for crane sheaves

Double-row, shielded type

d 40 ~ 150 mm

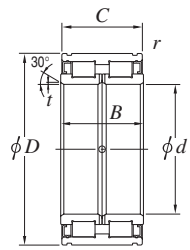

Design 1

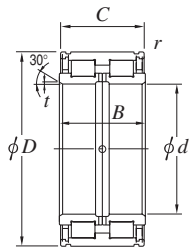

Design 2

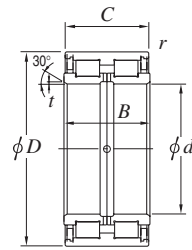

Design 3

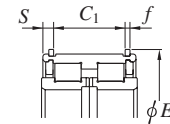

With locating snap rings

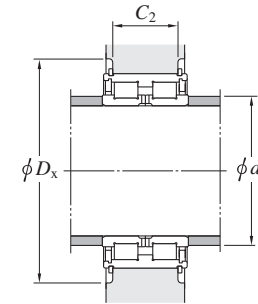

Boundary dimensions (mm)						Basic load ratings (kN)		Bearing No.		Design	Locating snap ring specifications (mm)				Mounting dimensions (mm)			(Refer.) Mass (kg)
d	D	B	C	t	r min.	C <sub>r</sub>	C <sub>0r</sub>	Without locating snap rings	With locating snap rings		C <sub>1</sub> <sup>1)</sup>	S	E	f	d <sub>a</sub> min.	D <sub>s</sub> min.	C <sub>2</sub> <sup>2)</sup>	
40	68	38	37	0.9	0.6	87.8	125	DC5008N	DC5008NR	1	28	4.5	71.8	2	46	80	28	0.55
45	75	40	39	0.9	0.6	95.1	144	DC5009N	DC5009NR	1	30	4.5	78.8	2	51	87	30	0.70
50	80	40	39	0.9	0.6	99.7	158	DC5010N	DC5010NR	1	30	4.5	83.8	2	56	92	30	0.75
55	90	46	45	1.2	0.6	118	193	DC5011N	DC5011NR	1	34	5.5	94.8	2.5	63	104	34	1.19
60	95	46	45	1.2	0.6	123	208	DC5012N	DC5012NR	1	34	5.5	99.8	2.5	68	109	34	1.27
65	100	46	45	1.2	0.6	128	224	DC5013N	DC5013NR	1	34	5.5	104.8	2.5	73	114	34	1.30
70	110	54	53	1.2	0.6	170	285	DC5014N	DC5014NR	1	42	5.5	114.5	2.5	78	124	42	1.94
75	115	54	53	1.2	0.6	178	307	DC5015N	DC5015NR	1	42	5.5	119.5	2.5	83	129	42	2.11
80	125	60	59	1.2	0.6	250	429	DC5016N	DC5016NR	1	48	5.5	129.5	2.5	88	146	48	2.65
85	130	60	59	1.2	0.6	255	446	DC5017N	DC5017NR	1	48	5.5	134.5	2.5	93	155	48	2.80
90	140	67	66	1.4	0.6	303	541	DC5018N	DC5018NR	1	54	6	145.4	2.5	100	165	54	3.70
95	145	67	66	1.4	0.6	310	562	DC5019N	DC5019NR	1	54	6	150.4	2.5	105	175	54	3.90
100	150	67	66	1.4	0.6	316	584	DC5020N	DC5020NR	1	54	6	155.4	2.5	110	180	54	4.05
110	170	80	79	1.7	1	382	697	DC5022N	DC5022NR	1	65	7	175.4	2.5	122	200	65	6.50
120	180	80	79	1.7	1	398	750	DC5024N	DC5024NR	1	65	7	188.4	3	132	210	65	6.95
130	200	95	94	1.7	1	534	1 000	DC5026N	DC5026NR	1	77	8.5	208.4	3	142	230	77	10.5
140	210	95	94	1.7	1	540	1 070	DC5028N	DC5028NR	1	77	8.5	218.4	3	152	245	77	11.0
150	225	100	99	2	1	682	1 400	DC5030N	DC5030NR	2	81	9	233	3	178.5	244	81	13.9

[Notes] 1) Dimensional tolerance of C<sub>1</sub> is +0.4/0 when bore diameter is not more than 170 mm, while +0.6/0 when bore diameter is over 170 mm.

2) Dimensional tolerance of C<sub>2</sub> is -0.1/-0.5 when bore diameter is not more than 170 mm, while -0.1/-0.7 when bore diameter is over 170 mm.

Full complement cylindrical roller bearings for crane sheaves

Double-row, shielded type

d 160 ~ 440 mm

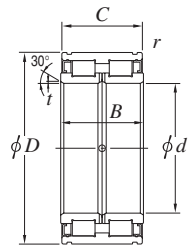

Design 1

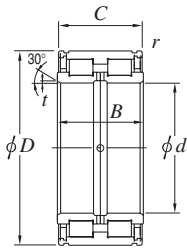

Design 2

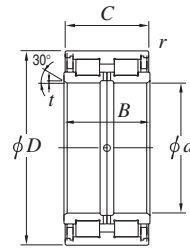

Design 3

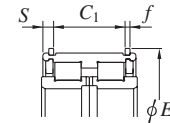

With locating snap rings

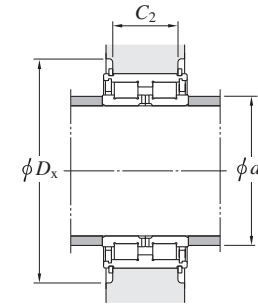

Boundary dimensions (mm)						Basic load ratings (kN)		Bearing No.		Design	Locating snap ring specifications (mm)				Mounting dimensions (mm)			(Refer.) Mass (kg)
d	D	B	C	t	r min.	C <sub>r</sub>	C <sub>0r</sub>	Without locating snap rings	With locating snap rings		C <sub>1</sub> <sup>1)</sup>	S	E	f	d <sub>a</sub> min.	D <sub>x</sub> min.	C <sub>2</sub> <sup>2)</sup>	
160	240	109	108	2	1.1	786	1 640	DC5032N	DC5032NR	2	89	9.5	248	3	190	259	89	17.2
170	260	122	121	2	1.1	977	2 020	DC5034N	DC5034NR	2	99	11	270	4	204	286	99	23.1
180	280	136	135	2	1.1	1 150	2 440	DC5036N	DC5036NR	2	110	12.5	290	4	217.5	306	110	30.8
190	290	136	135	2	1.1	1 180	2 530	DC5038N	DC5038NR	2	110	12.5	300	4	225	316	110	32.4
200	310	150	149	2	1.1	1 390	2 980	DC5040N	DC5040NR	2	120	14.5	320	4	240	336	120	41.7
220	340	160	159	2.5	1.1	1 620	3 590	DC5044N	DC5044NR	2	130	14.5	356	6	266.5	380	130	53.5
240	360	160	159	2.5	1.1	1 690	3 850	DC5048N	DC5048NR	2	130	14.5	376	6	284.5	400	130	57.3
260	400	190	189	3	1.5	2 230	4 980	DC5052N	DC5052NR	2	154	17.5	416	7	312.5	444	154	87.2
280	420	190	189	3	1.5	2 330	5 350	DC5056N	DC5056NR	2	154	17.5	436	7	334.5	464	154	93.0
300	460	218	216	3	1.5	2 860	6 610	DC5060	—	3	—	—	—	361	—	—	134	
320	480	218	216	3	1.5	2 950	6 930	DC5064	—	3	—	—	—	378.5	—	—	140	
340	520	243	241	3.5	2	3 590	8 420	DC5068	—	3	—	—	—	413	—	—	189	
360	540	243	241	3.5	2	3 660	8 720	DC5072	—	3	—	—	—	427	—	—	197	
380	560	243	241	3.5	2	3 730	9 020	DC5076	—	3	—	—	—	441	—	—	207	
400	600	272	270	3.5	2	4 510	11 000	DC5080	—	3	—	—	—	475.5	—	—	281	
420	620	272	270	3.5	2	4 650	11 400	DC5084	—	3	—	—	—	496	—	—	290	
440	650	280	278	4.5	3	4 940	12 200	DC5088	—	3	—	—	—	521	—	—	330	

[Notes] 1) Dimensional tolerance of C<sub>1</sub> is +0.4/0 when bore diameter is not more than 170 mm, while +0.6/0 when bore diameter is over 170 mm.

2) Dimensional tolerance of C<sub>2</sub> is -0.1/-0.5 when bore diameter is not more than 170 mm, while -0.1/-0.7 when bore diameter is over 170 mm.

# Tapered roller bearings



■ Single-row (page 192)

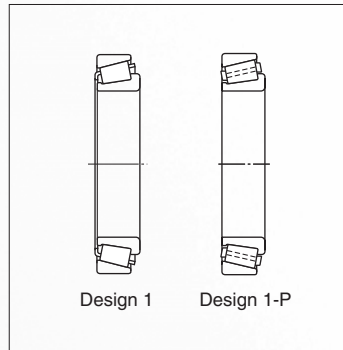

- Able to carry radial and axial load in one direction simultaneously. Combined radial and axial load can be also accommodated. Suitable for heavy load and impact load.
- The larger the contact angle ( $\alpha$ ), the greater the bearing resistance to axial load. {Steep angle type ...  $\alpha \geq 25^\circ$  (constant  $e \geq 0.67$ )}
- Koyo tapered roller bearings whose bearing numbers are suffixed by "J" are precision ground in accordance with the ISO 355 (Sub-unit, Metric Series) specifying the outer ring width and small inside diameter as well as the contact angle, so that outer rings and inner ring assembly (inner ring, rollers and cage assembly) of these bearings are internationally interchangeable.

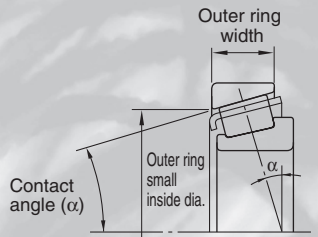

ISO sub-unit specifications

[Note] When supplementary code "J" is added as a prefix (not a suffix) to bearing numbers (e.g. JHM720249/JHM720210), the bearings are not designed according to ISO 355. Such bearings are called "J series metric tapered roller bearings," and are produced according to special tolerances.

■ Double-row (Face to face)

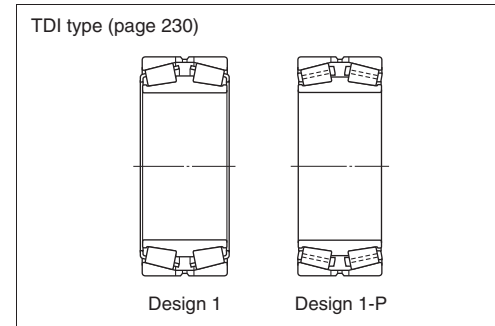

- The TDI type bearing is made up of two single-row outer rings and one double inner ring, and is generally provided with an outer ring spacer. The bearing with outer ring spacer is handy for mounting, as its end play has been pre-adjusted for each application.
- The spacer is provided with a lubrication groove and several lubrication holes.
- Used for roll neck of medium-duty rolling mills, speed reducers, etc.

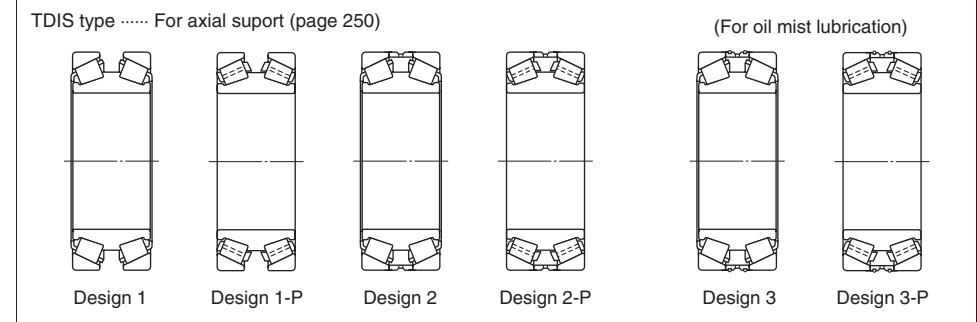

- The TDIS type bearing is of the same construction as the TDI type, except that it has a larger contact angle so that it can accommodate heavier axial load.
- Used for applications where the axial load is greater than the radial load or where only the axial load is applied. The bearing with the key way on the inner ring is mainly used for rolling mill roll necks. The bearing may be also used with preload without using the outer ring spacer.
- The bearing having lubrication holes and O-rings on its outer ring is used for oil mist lubrication.

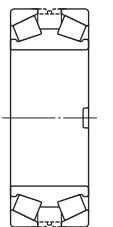

(Example of key way)

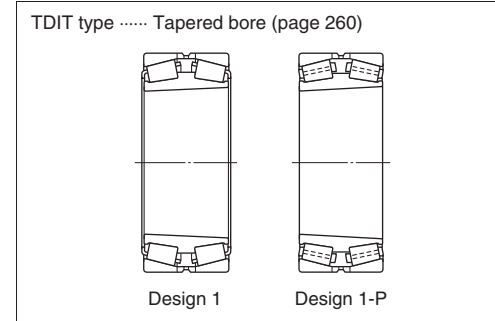

- Where the interference fit is necessary, and needs to be removed frequently, the use of TDIT type is convenient. It is also possible to mount the bearing on the shaft by using an adaptor sleeve.
- Used for roll neck of light or medium-duty rolling mills and roll neck of calendar mills.
- The use of a hydraulic unit will facilitate bearing mounting/dismounting.
- The roll neck taper needs to be matched to the bore diameter of bearing by using taper gauge, sign bar gauge, etc.



■ Double-row (Back to back)

TDO, TDOS type (page 264)

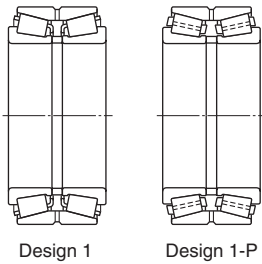

Design 1

Design 1-P

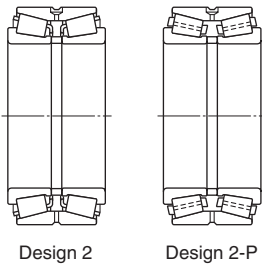

Design 2

Design 2-P

- The TDO type bearing is made up of one double outer ring, two single-row inner rings and one inner ring spacer. The outer ring is provided with several lubrication holes.
- The inner ring spacer has been adjusted to provide an end play suitable to each application. It is also possible to freely adjust the end play for use by removing the inner ring spacer, however, it requires time and labor.
- Suitable to case where moment may act. Used for speed reducer, winding machine, etc.
- The steep angle type (TDOS type) having large contact angle has increased axial load capacity, and is widely used for worm shaft of medium, heavy duty applications, thrust bearing of reducers etc.

TNA type (page 310)

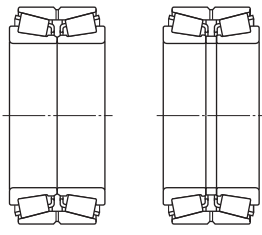

Design 1

Design 2  
(with inner ring spacer)

- The TNA type bearing has different assembled width tolerance from the TDO type, specially selected for the TNA type.

[Reference] Features of bearing with pin type cage

(1) Load rating can be increased.

The pin type cage accommodates a larger number of rollers, thus making it possible to increase the load rating of bearing.

(2) Reduced friction resistance

Friction coefficient of pin type cage is reduced, as contact area of roller and cage is limited.

(3) Easy mounting/dismounting

The pin type cage is provided with a tap hole for lifting.

The use of tap hole will facilitate the work.

Use ISO metric thread for lifting tap screw.

■ Four-row

TQO type (page 314)

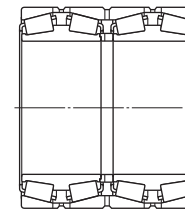

Design 1

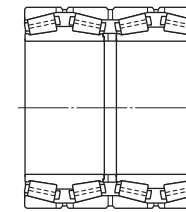

Design 1-P

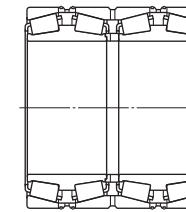

Design 2

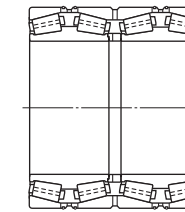

Design 2-P

(For oil mist lubrication)

45D type (page 348)

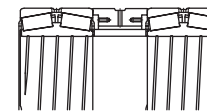

Design 1

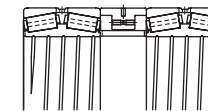

Design 1-P

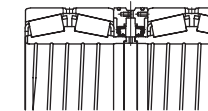

Design 2

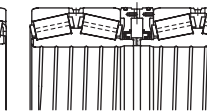

Design 2-P

Sealed type (page 352)

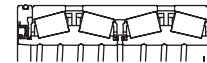

Design 1

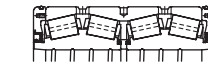

Design 1-P



Design 2

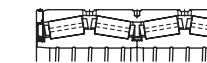

Design 2-P

- The four-row tapered roller bearing with cylindrical bore is designed to maximize the load capacity with minimum space, and is widely used for roll neck of lower, medium speed rolling mills.
- The bearing of this type is made up of one double outer ring, two single-row outer rings, two double inner rings and inner ring spacer/ outer ring spacer. Since each component is not interchangeable, it is necessary to assemble each component as specified with care taken to the matching marks marked on the bearing.
- Since the internal clearance has been pre-adjusted, the bearing can be used with ease without any necessity of readjustment.
- Since the bearing needs to be removed frequently and is clearance-fitted to the roll neck, the inner ring spacer is hardened to avoid wear. The lubrication grooves are provided on both sides of the inner ring spacer to allow the lubricant to be readily passed to the roll neck.

The lubrication groove and lubrication holes are provided at the outside diameter of double outer ring and outer ring spacer.

- The bearing provided with lubrication holes and O-rings on the outer ring is used for oil mist lubrication.
- Sealed type four-row tapered roller bearings have oil seals on their side faces and in between inner rings, and O-rings on their outside surfaces to achieve the purposes below.
  - Reduction in frequency of disassembly, washing, and reassembly
  - Improvement in working environment of disassembly, washing, and reassembly
  - Reduction in grease consumption
  - Improvement in ambient surrounding rolling mills
- Design 2 shows the compact oil seal type to increase the load rating of a four-row tapered roller bearing. The intermediate seal in the Design 2 has advantages below.
  - Compact
  - Easy disassembly, washing, and reassembly

[Applicable tolerance for tapered roller bearings]

Type of tapered roller bearings		Applicable tolerance*
Single-row	Metric series	32900JR, 32000JR, 33000JR, 33100JR, 30200JR, 32200JR, 33200JR, 30300JR, 31300JR, 32300JR
	Inch series	(56418/56650, HM125943/HM125910 etc.)
	Metric J series	(JHM720249/JHM720210 etc.)
Double-row Four-row	Metric series	45200, 45300, 46200(A), 46300(A), 46T30200JR, 46T32200JR, 46T30300JR, 46T32300JR, 37200, 47200, 47300
	Inch series	(LM377449D/LM377410, 67388/67322D, EE127094D/127138/127139D etc.)
	The others	45T..., 46T..., 47T..., 2TR..., 4TR...

\* Consult with JTEKT if a higher tolerance class than that shown in this table is necessary.

<b>Allowable misalignment</b>	Single-row tapered roller bearings : 0.000 9 rad (3') (If the misalignment exceeds this angle size, JTEKT is ready to design special bearings to order.)	
<b>Radial internal clearance</b>	(refer to Table 4-5 on page 49) ..... Radial internal clearance of double-row and four-row tapered roller bearings	
<b>Standard cage</b>	Pressed cage or pin type cage	
<b>Equivalent radial load</b>	Single-row	<b>Dynamic equivalent radial load</b> $\left( \text{when } \frac{F_a}{F_r} \leq e \right) P_r = F_r$ $\left( \text{when } \frac{F_a}{F_r} > e \right) P_r = 0.4F_r + Y_1F_a$
		<b>Static equivalent radial load</b> $P_{0r} = 0.5F_r + Y_0F_a$ when $P_{0r} < F_r$ , $P_{0r} = F_r$
	Double-row four-row	<b>Dynamic equivalent radial load</b> $\left( \text{when } \frac{F_a}{F_r} \leq e \right) P_r = F_r + Y_2F_a$ $\left( \text{when } \frac{F_a}{F_r} > e \right) P_r = 0.67F_r + Y_3F_a$
		<b>Static equivalent radial load</b> $P_{0r} = F_r + Y_0F_a$

[Note]  
Refer to the bearing specification table for the values of axial load factors  $Y_1$ ,  $Y_2$ ,  $Y_3$  and  $Y_0$  and constant  $e$ .

Dynamic equivalent load calculation : when a pair of single-row tapered roller bearings is arranged face-to-face or back-to-back.

While radial loads  $F_{rA}$  and  $F_{rB}$  are applied to bearings A and B, axial load  $K_a$  externally acts in the directions shown in the figures below.

[Remark]

When radial load is applied to a single-row tapered roller bearing, axial load generated as an axial component of force acts on another bearing. The axial load can be obtained by the following equation.

$$F_a = \frac{F_r}{2Y_1}$$

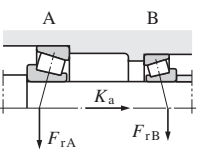
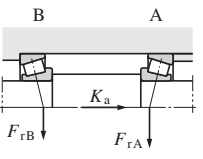
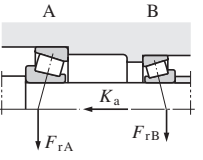
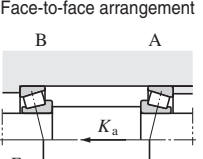
Paired mounting	Loading condition	Bearing	Axial load	Dynamic equivalent load
Back-to-back arrangement 	$\frac{F_{rB}}{2Y_B} + K_a \geq \frac{F_{rA}}{2Y_A}$	Bearing A	$\frac{F_{rB}}{2Y_B} + K_a$	$P_A = XF_{rA} + Y_A \left( \frac{F_{rB}}{2Y_B} + K_a \right)$ $P_A = F_{rA}$ , where $P_A < F_{rA}$
		Bearing B	-	$P_B = F_{rB}$
Face-to-face arrangement 	$\frac{F_{rB}}{2Y_B} + K_a < \frac{F_{rA}}{2Y_A}$	Bearing A	-	$P_A = F_{rA}$
		Bearing B	$\frac{F_{rA}}{2Y_A} - K_a$	$P_B = XF_{rB} + Y_B \left( \frac{F_{rA}}{2Y_A} - K_a \right)$ $P_B = F_{rB}$ , where $P_B < F_{rB}$
Back-to-back arrangement 	$\frac{F_{rB}}{2Y_B} \leq \frac{F_{rA}}{2Y_A} + K_a$	Bearing A	-	$P_A = F_{rA}$
		Bearing B	$\frac{F_{rA}}{2Y_A} + K_a$	$P_B = XF_{rB} + Y_B \left( \frac{F_{rA}}{2Y_A} + K_a \right)$ $P_B = F_{rB}$ , where $P_B < F_{rB}$
Face-to-face arrangement 	$\frac{F_{rB}}{2Y_B} > \frac{F_{rA}}{2Y_A} + K_a$	Bearing A	$\frac{F_{rB}}{2Y_B} - K_a$	$P_A = XF_{rA} + Y_A \left( \frac{F_{rB}}{2Y_B} - K_a \right)$ $P_A = F_{rA}$ , where $P_A < F_{rA}$
		Bearing B	-	$P_B = F_{rB}$

[Remarks] 1. These equations can be used when internal clearance and preload during operation are zero.

2. Radial load is treated as positive in the calculation, if it is applied in a direction opposite that shown in Fig. above table.

# Single-row tapered roller bearings

d 100 ~ (105) mm

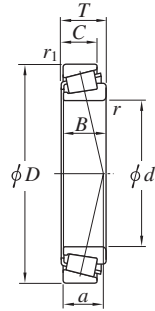

Design 1

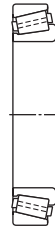

Design 1-P

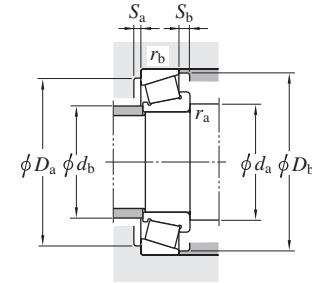

Boundary dimensions										Bearing No. <sup>1)</sup>	De- sign	Basic load ratings (kN)		Load center (mm)	Mounting dimensions (mm)								Con- stant e	Axial load factors		(Refer.) Mass (kg)								
d	D		T		B		C		r			r <sub>1</sub>	C <sub>r</sub>		C <sub>0r</sub>	a	d <sub>a</sub>	d <sub>b</sub>	D <sub>a</sub>		D <sub>b</sub>			S <sub>a</sub>	S <sub>b</sub>		r <sub>a</sub>	r <sub>b</sub>	Y <sub>1</sub>	Y <sub>0</sub>				
mm	1/25.4	mm	1/25.4	mm	1/25.4	mm	1/25.4	mm	1/25.4			min.	min.			min.	max.	max.	min.	min.	min.	min.	max.	max.										
100	—	140	—	25	—	25	—	20	—	1.5	1.5	32920JR	1	126	217	24.0	109	108	131	128	135	5	5	1.5	1.5	0.33	1.82	1.00	1.19					
	—	150	—	32	—	32	—	24	—	2	1.5						32020JR	1	185	298	32.6	110	109	141	134	144	6	8	2	1.5	0.46	1.31	0.72	1.95
	—	150	—	39	—	39	—	32.5	—	2	1.5						33020JR	1	231	397	28.6	110	108	141	135	143	7	6.5	2	1.5	0.29	2.09	1.15	2.40
100.000	3.9370	155.000	6.1024	36.000	1.4173	35.000	1.3780	28.000	1.1024	3.0	2.5	JM720249/JM720210	1	204	328	35.6	110	110	146	139	148	5.9	8	3.0	2.5	0.47	1.27	0.70	2.40					
	3.9370	160.000	6.2992	41.000	1.6142	40.000	1.5748	32.000	1.2598	3.0	2.5						JHM720249/JHM720210	1	237	378	38.3	110	111	151	143	153	6.4	9	3.0	2.5	0.47	1.28	0.70	3.08
100	—	165	—	52	—	52	—	40	—	2.5	2	33120JR	1	325	523	40.1	112	111	155	142	159	8	12	2	2	0.41	1.48	0.81	4.29					
	—	180	—	37	—	34	—	29	—	3	2.5						30220JR	1	258	338	36.8	114	116	168	157	168	5	8	2.5	2	0.42	1.43	0.79	3.83
	—	180	—	49	—	46	—	39	—	3	2.5						32220JR	1	347	495	42.1	114	114	168	154	171	5	10	2.5	2	0.42	1.43	0.79	5.21
	—	180	—	63	—	63	—	48	—	3	2.5						33220JR	1	431	680	45.7	114	112	168	151	172	10	15	2.5	2	0.40	1.48	0.82	6.92
100.000	3.9370	200.000	7.8740	52.761	2.0772	49.213	1.9375	34.925	1.3750	3.6	3.2	98394X/98788	1	347	471	54.7	112	123	189	170	185	4.8	17.8	3.6	3.2	0.63	0.95	0.52	6.91					
100	—	215	—	56.5	—	51	—	35	—	4	3	31320JR	1	373	459	67.7	118	120	201	183	202	6	17.5	3	2.5	0.83	0.73	0.40	8.72					
100.012	3.9375	157.162	6.1875	36.512	1.4375	36.116	1.4219	26.195	1.0313	3.6	3.2	52393/52618	1	180	288	36.0	113	115	145	142	150	5	10.3	3.6	3.2	0.47	1.26	0.69	2.43					
101.600	4.0000	146.050	5.7500	21.433	0.8438	21.433	0.8438	16.670	0.6563	1.6	1.6	L521945R/L521910	1	86.4	167	26.2	110	119	137	134	138	4	4.8	1.6	1.6	0.39	1.53	0.84	1.17					
	4.0000	157.162	6.1875	36.512	1.4375	36.116	1.4219	26.195	1.0313	3.6	3.2	52400/52618	1	180	288	36.0	114	115	145	142	150	5	10.3	3.6	3.2	0.47	1.26	0.69	2.36					
	4.0000	161.925	6.3750	36.513	1.4375	36.116	1.4219	26.195	1.0313	3.6	3.2	52400/52637	1	180	288	36.0	114	115	150	142	150	5	10.3	3.6	3.2	0.47	1.26	0.69	2.60					
	4.0000	168.275	6.6250	41.275	1.6250	41.275	1.6250	30.162	1.1875	3.6	3.2	687/672	1	224	349	38.6	114	115	156	146	156	4.7	11.1	3.6	3.2	0.47	1.28	0.70	3.37					
	4.0000	180.975	7.1250	47.625	1.8750	48.006	1.8900	38.100	1.5000	3.6	3.2	780/772	1	288	438	39.5	114	120	169	156	165	4.2	9.5	3.6	3.2	0.39	1.56	0.86	5.01					
	4.0000	190.500	7.5000	57.150	2.2500	57.531	2.2650	46.038	1.8125	7.9	3.2	HH221449/HH221410	1	440	602	42.5	123	119	179	168	178	5.9	11.1	7.9	3.2	0.33	1.79	0.99	6.93					
	4.0000	200.000	7.8740	52.761	2.0772	49.212	1.9375	34.925	1.3750	3.6	3.2	98400/98788	1	347	471	54.5	114	123	188	170	185	4.8	17.8	3.6	3.2	0.63	0.95	0.52	6.83					
	4.0000	212.725	8.3750	66.675	2.6250	66.675	2.6250	53.975	2.1250	7.1	3.2	941/932	1	450	674	47.6	121	135	201	181	192	4	12.7	7.1	3.2	0.33	1.84	1.01	11.1					
4.0000	212.725	8.3750	66.675	2.6250	66.675	2.6250	53.975	2.1250	7.1	3.2	HH224335/HH224310	1	513	699	47.6	121	134	201	189	201	7	12.7	7.1	3.2	0.33	1.84	1.01	10.8						
104.775	4.1250	180.975	7.1250	47.625	1.8750	48.006	1.8900	38.100	1.5000	3.6	3.2	782/772	1	288	438	39.5	117	120	169	156	165	4.2	9.5	3.6	3.2	0.39	1.56	0.86	4.82					
	4.1250	180.975	7.1250	47.625	1.8750	48.006	1.8900	38.100	1.5000	6.4	3.2	786/772	1	288	438	39.5	123	120	169	156	165	4.2	9.5	6.4	3.2	0.39	1.56	0.86	4.80					
	4.1250	190.500	7.5000	47.625	1.8750	49.212	1.9375	34.925	1.3750	3.6	3.2	71412/71750	1	303	483	40.9	117	131	179	167	177	6.4	12.7	3.6	3.2	0.42	1.44	0.79	5.68					
105	—	145	—	25	—	25	—	20	—	1.5	1.5	32921JR	1	128	224	25.1	114	113	136	133	140	5	5	1.5	1.5	0.34	1.75	0.96	1.23					

[Note] 1) While metric series bearings have minus tolerances for bore and OD, inch series have plus tolerances. Refer to page 190 for details of applicable tolerance standards.

# Single-row tapered roller bearings

d (105) ~ (114.300) mm

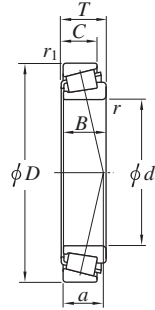

Design 1



Design 1-P

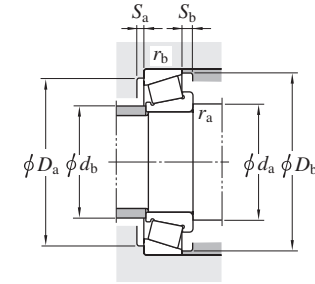

Boundary dimensions								Bearing No. <sup>1)</sup>	De- sign	Basic load ratings (kN)		Load center (mm)	Mounting dimensions (mm)								Constant e	Axial load factors		(Refer.) Mass (kg)							
d	D	T	B	C	r	r <sub>1</sub>	C <sub>r</sub>			C <sub>0r</sub>	a		d <sub>a</sub>	d <sub>b</sub>	D <sub>a</sub>	D <sub>b</sub>	S <sub>a</sub>	S <sub>b</sub>	r <sub>a</sub>	r <sub>b</sub>		Y <sub>1</sub>	Y <sub>0</sub>								
mm	1/25.4	mm	1/25.4	mm	1/25.4	mm	1/25.4			min.	min.	min.	max.	min.	max.	min.	min.	max.	max.												
<b>105</b>	—	160	—	35	—	35	—	26	—	2.5	2	<b>32021JR</b>	1	215	344	34.5	117	116	150	143	154	6	9	2	2	0.44	1.35	0.74	2.45		
	—	160	—	43	—	43	—	34	—	2.5	2		<b>33021JR</b>	1	267	461	30.9	117	116	150	145	153	7	9	2	2	0.28	2.12	1.17	3.08	
	—	190	—	39	—	36	—	30	—	3	2.5			<b>30221JR</b>	1	288	380	39.0	119	122	178	165	178	6	9	2.5	2	0.42	1.43	0.79	4.49
	—	190	—	53	—	50	—	43	—	3	2.5		<b>32221JR</b>		1	392	567	44.8	119	120	178	161	180	6	10	2.5	2	0.42	1.43	0.79	6.37
	—	225	—	58	—	53	—	36	—	4	3				<b>31321JR</b>	1	397	489	70.3	123	126	211	193	211	6	18	3	2.5	0.83	0.73	0.40
<b>106.362</b>	4.1875	165.100	6.5000	36.513	1.4375	36.513	1.4375	26.988	1.0625	3.6	3.2	<b>56418/56650</b>	1	184	300	38.5	119	120	153	148	157	5.5	9.5	3.6	3.2	0.50	1.21	0.66	2.65		
<b>107.950</b>	4.2500	158.750	6.2500	23.020	0.9063	21.438	0.8440	15.875	0.6250	3.6	3.2	<b>37425/37625</b>	1	104	169	36.5	121	121	147	141	148	4.3	7.1	3.6	3.2	0.61	0.99	0.54	1.38		
	4.2500	161.925	6.3750	34.925	1.3750	34.925	1.3750	26.988	1.0625	3.6	3.2	<b>48190/48120</b>	1	173	293	39.1	121	120	150	145	154	4.2	7.9	3.6	3.2	0.51	1.19	0.65	2.39		
	4.2500	165.100	6.5000	36.513	1.4375	36.513	1.4375	26.988	1.0625	3.6	3.2		<b>56425/56650</b>	1	184	300	38.5	121	120	153	148	157	5.5	9.5	3.6	3.2	0.50	1.21	0.66	2.57	
	4.2500	190.500	7.5000	47.625	1.8750	49.212	1.9375	34.925	1.3750	3.6	3.2	<b>71425/71750</b>	1	303	483	40.9	121	131	179	167	177	6.4	12.7	3.6	3.2	0.42	1.44	0.79	5.48		
	4.2500	212.725	8.3750	66.675	2.6250	66.675	2.6250	53.975	2.1250	7.9	3.2		<b>HH224340/HH224310</b>	1	513	699	47.6	129	134	201	189	201	7	12.7	7.9	3.2	0.33	1.84	1.01	10.2	
<b>109.987</b>	4.3302	159.987	6.2987	34.925	1.3750	34.925	1.3750	26.988	1.0625	7.9	3.2	<b>LM522548/LM522510</b>	1	184	319	32.9	131	121	148	146	153	5.5	7.9	7.9	3.2	0.40	1.50	0.82	2.30		
	4.3302	159.987	6.2987	34.925	1.3750	34.925	1.3750	26.988	1.0625	3.6	3.2		<b>LM522549/LM522510</b>	1	184	319	32.9	123	121	148	146	153	5.5	7.9	3.6	3.2	0.40	1.50	0.82	2.33	
<b>110</b>	—	150	—	25	—	25	—	20	—	1.5	1.5	<b>32922JR</b>	1	129	231	26.3	119	118	141	138	145	5	5	1.5	1.5	0.36	1.69	0.93	1.28		
<b>110.000</b>	4.3307	165.000	6.4961	35.000	1.3780	35.000	1.3780	26.500	1.0433	3.0	2.5	<b>JM822049/JM822010</b>	1	195	325	38.1	121	121	155	148	157	4.8	8.5	3.0	2.5	0.50	1.21	0.66	2.44		
<b>110</b>	—	170	—	38	—	38	—	29	—	2.5	2	<b>32022JR</b>	1	248	395	36.1	122	122	160	152	163	7	9	2	2	0.43	1.39	0.77	3.12		
	—	170	—	47	—	47	—	37	—	2.5	2		<b>33022JR</b>	1	287	502	33.4	122	123	160	152	161	7	10	2	2	0.29	2.09	1.15	3.81	
<b>110.000</b>	4.3307	180.000	7.0866	47.000	1.8504	46.000	1.8110	38.000	1.4961	3.0	2.5	<b>JHM522649/JHM522610</b>	1	306	487	40.6	121	125	170	160	171	6	9	3.0	2.5	0.41	1.48	0.81	4.57		
<b>110</b>	—	180	—	56	—	56	—	43	—	2.5	2	<b>33122JR</b>	1	369	634	44.5	122	121	170	155	174	9	13	2	2	0.42	1.43	0.79	5.52		
	—	200	—	41	—	38	—	32	—	3	2.5	<b>30222JR</b>	1	324	434	40.8	124	129	188	174	188	6	9	2.5	2	0.42	1.43	0.79	5.33		
	—	200	—	56	—	53	—	46	—	3	2.5	<b>32222JR</b>	1	438	640	46.7	124	126	188	170	190	6	10	2.5	2	0.42	1.43	0.79	7.45		
	—	240	—	54.5	—	50	—	42	—	4	3	<b>30322JR</b>	1	481	590	46.3	128	141	226	206	222	8	12.5	3	2.5	0.35	1.74	0.96	11.4		
<b>114.300</b>	4.5000	180.975	7.1250	34.925	1.3750	31.750	1.2500	25.400	1.0000	3.6	3.2	<b>68450/68712</b>	1	171	247	40.6	127	131	169	161	169	2.5	9.5	3.6	3.2	0.50	1.21	0.66	2.92		
	4.5000	190.500	7.5000	47.625	1.8750	49.212	1.9375	34.925	1.3750	3.6	3.2		<b>71450/71750</b>	1	303	483	40.9	127	131	179	167	177	6.4	12.7	3.6	3.2	0.42	1.44	0.79	5.05	

[Note] 1) While metric series bearings have minus tolerances for bore and OD, inch series have plus tolerances. Refer to page 190 for details of applicable tolerance standards.

# Single-row tapered roller bearings

*d* (114.300) ~ (127.000) mm

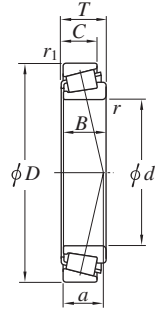

Design 1



Design 1-P

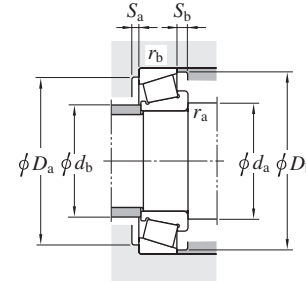

Boundary dimensions							Bearing No. 1)	De- sign	Basic load ratings (kN)		Load center (mm) <i>a</i>	Mounting dimensions (mm)								Constant <i>e</i>	Axial load factors		(Refer.) Mass (kg)						
<i>d</i> mm	<i>D</i> mm	<i>T</i> mm	<i>B</i> mm	<i>C</i> mm	<i>r</i> min.	<i>r<sub>1</sub></i> min.			<i>C<sub>r</sub></i>	<i>C<sub>0r</sub></i>		<i>d<sub>a</sub></i> min.	<i>d<sub>b</sub></i> max.	<i>D<sub>a</sub></i> max.	<i>D<sub>b</sub></i> min.	<i>S<sub>a</sub></i> min.	<i>S<sub>b</sub></i> min.	<i>r<sub>a</sub></i> max.	<i>r<sub>b</sub></i> max.		<i>Y<sub>1</sub></i>	<i>Y<sub>0</sub></i>							
114.300	4.5000	212.725	8.3750	66.675	2.6250	66.675	2.6250	53.975	2.1250	7.1	3.2	<b>HH224346/HH224310</b>	1	513	699	47.6	134	134	201	189	201	7	12.7	7.1	3.2	0.33	1.84	1.01	9.67
	4.5000	228.600	9.0000	53.975	2.1250	49.428	1.9460	38.100	1.5000	3.6	3.2	<b>97450/97900</b>	1	325	459	65.6	127	144	217	193	212	5	15.9	3.6	3.2	0.74	0.81	0.45	9.17
	4.5000	228.600	9.0000	53.975	2.1250	49.428	1.9460	38.100	1.5000	3.6	3.2	<b>HM926740/HM926710</b>	1	430	651	67.9	127	148	217	200	218	7	15.9	3.6	3.2	0.74	0.81	0.45	10.0
	4.5000	273.050	10.7500	82.550	3.2500	82.550	3.2500	53.975	2.1250	6.4	6.4	<b>HH926744/HH926710</b>	1	707	898	76.1	133	151	255	230	252	7	28.6	6.4	6.4	0.63	0.95	0.52	21.9
114.976	4.5266	212.725	8.3750	66.675	2.6250	66.675	2.6250	53.975	2.1250	7.1	3.2	<b>HH224349/HH224310</b>	1	513	699	47.6	135	134	201	189	201	7	12.7	7.1	3.2	0.33	1.84	1.01	9.61
115.087	4.5310	190.500	7.5000	47.625	1.8750	49.212	1.9375	34.925	1.3750	7.9	3.2	<b>71455/71750</b>	1	303	483	40.9	136	131	179	167	177	6.4	12.7	7.9	3.2	0.42	1.44	0.79	4.97
117.475	4.6250	179.975	7.0856	34.925	1.3750	31.750	1.2500	25.400	1.0000	3.6	0.8	<b>68462/68709</b>	1	171	247	40.7	130	131	173	161	169	2.5	9.5	3.6	0.8	0.50	1.21	0.66	2.73
	4.6250	180.975	7.1250	34.925	1.3750	31.750	1.2500	25.400	1.0000	3.6	3.2	<b>68462/68712</b>	1	171	247	40.6	130	131	169	161	169	2.5	9.5	3.6	3.2	0.50	1.21	0.66	2.78
120	—	165	—	29	—	29	—	23	—	1.5	1.5	<b>32924JR</b>	1	172	298	29.4	129	128	156	152	160	6	6	1.5	1.5	0.35	1.72	0.95	1.77
	—	180	—	38	—	38	—	29	—	2.5	2	<b>32024JR</b>	1	258	427	38.8	132	131	170	161	173	7	9	2	2	0.46	1.31	0.72	3.34
	—	180	—	48	—	48	—	38	—	2.5	2	<b>33024JR</b>	1	299	540	36.2	132	132	170	160	171	6	10	2	2	0.31	1.97	1.08	4.16
	—	200	—	62	—	62	—	48	—	2.5	2	<b>33124JR</b>	1	462	785	47.8	132	133	190	172	192	9	14	2	2	0.40	1.51	0.83	7.73
	—	215	—	43.5	—	40	—	34	—	3	2.5	<b>30224JR</b>	1	347	473	44.2	134	140	203	187	203	6	9.5	2.5	2	0.44	1.38	0.76	6.36
	—	215	—	61.5	—	58	—	50	—	3	2.5	<b>32224JR</b>	1	470	691	51.6	134	136	203	181	204	7	11.5	2.5	2	0.44	1.38	0.76	9.04
120.000	4.7244	230.000	9.0551	53.975	2.1250	49.428	1.9460	38.100	1.5000	3.6	3.2	<b>97472X/97905X</b>	1	325	459	65.6	133	144	218	193	212	5	15.9	3.6	3.2	0.74	0.81	0.45	8.91
120	—	260	—	68	—	62	—	42	—	4	3	<b>31324JR</b>	1	526	665	81.9	138	145	246	221	244	6	21	3	2.5	0.83	0.73	0.40	15.4
120.650	4.7500	234.950	9.2500	63.500	2.5000	63.500	2.5000	49.213	1.9375	6.4	3.2	<b>95475/95925</b>	1	523	826	49.9	139	155	223	204	216	8	14.3	6.4	3.2	0.37	1.62	0.89	12.3
123.825	4.8750	182.563	7.1875	39.688	1.5625	38.100	1.5000	33.338	1.3125	3.6	3.2	<b>48286/48220</b>	1	227	429	34.1	136	141	171	166	173	3.8	6.4	3.6	3.2	0.31	1.97	1.08	3.42
125.298	4.9330	228.600	9.0000	53.975	2.1250	49.428	1.9460	38.100	1.5000	3.6	3.2	<b>HM926745/HM926710</b>	1	430	651	68.1	138	148	217	200	218	7	15.9	3.6	3.2	0.74	0.81	0.45	9.23
127.000	5.0000	182.563	7.1875	39.688	1.5625	38.100	1.5000	33.338	1.3125	3.6	3.2	<b>48290/48220</b>	1	227	429	34.1	140	141	171	166	173	3.8	6.4	3.6	3.2	0.31	1.97	1.08	3.24
	5.0000	196.850	7.7500	46.038	1.8125	46.038	1.8125	38.100	1.5000	3.6	3.2	<b>67388/67322</b>	1	311	561	39.7	140	148	185	180	188	5	7.9	3.6	3.2	0.34	1.74	0.96	5.05
	5.0000	203.200	8.0000	46.038	1.8125	46.038	1.8125	38.100	1.5000	3.6	3.2	<b>67388/67320</b>	1	311	561	39.7	140	148	191	180	188	5	7.9	3.6	3.2	0.34	1.74	0.96	5.64
	5.0000	215.900	8.5000	47.625	1.8750	47.625	1.8750	34.925	1.3750	3.6	3.2	<b>74500/74850</b>	1	322	549	49.7	140	156	204	193	204	5	12.7	3.6	3.2	0.49	1.23	0.68	6.83

[Note] 1) While metric series bearings have minus tolerances for bore and OD, inch series have plus tolerances. Refer to page 190 for details of applicable tolerance standards.

# Single-row tapered roller bearings

$d$  (127.000) ~ (139.700) mm

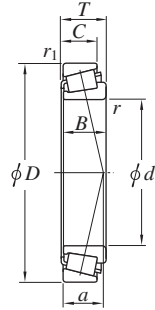

Design 1



Design 1-P

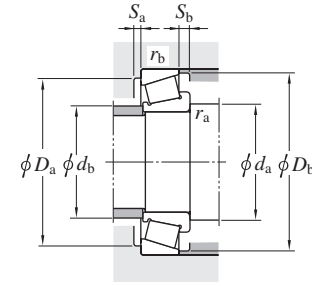

Boundary dimensions										Bearing No. <sup>1)</sup>	De- sign	Basic load ratings (kN)		Load center (mm) <i>a</i>	Mounting dimensions (mm)								Con- stant <i>e</i>	Axial load factors		(Refer.) Mass (kg)			
<i>d</i>	<i>D</i>	<i>T</i>	<i>B</i>	<i>C</i>	<i>r</i>	<i>r</i> <sub>1</sub>			<i>C</i> <sub>r</sub>			<i>C</i> <sub>0r</sub>	<i>d</i> <sub>a</sub>		<i>d</i> <sub>b</sub>	<i>D</i> <sub>a</sub>	<i>D</i> <sub>b</sub>	<i>S</i> <sub>a</sub>	<i>S</i> <sub>b</sub>	<i>r</i> <sub>a</sub>	<i>r</i> <sub>b</sub>	<i>Y</i> <sub>1</sub>		<i>Y</i> <sub>0</sub>					
mm	1/25.4	mm	1/25.4	mm	1/25.4	mm	1/25.4	mm	1/25.4			mm	1/25.4	min.	min.	max.	min.	min.	min.	min.	max.	max.							
127.000	5.0000	228.600	9.0000	53.975	2.1250	49.428	1.9460	38.100	1.5000	3.6	3.2	HM926747/HM926710	1	430	651	68.1	140	148	217	200	218	7	15.9	3.6	3.2	0.74	0.81	0.45	9.10
	5.0000	234.950	9.2500	63.500	2.5000	63.500	2.5000	49.213	1.9375	6.4	3.2	95500/95925	1	523	826	49.9	145	155	223	204	216	8	14.3	6.4	3.2	0.37	1.62	0.89	11.7
	5.0000	254.000	10.0000	77.788	3.0625	82.550	3.2500	61.912	2.4375	9.5	6.4	HH228349/HH228310	1	717	1 050	54.3	151	158	236	219	233	9	15.9	9.5	6.4	0.32	1.87	1.03	17.8
	5.0000	304.800	12.0000	88.900	3.5000	82.550	3.2500	57.150	2.2500	6.4	6.4	HH932132/HH932110	1	791	1 060	92.1	145	178	287	259	287	7	31.8	6.4	6.4	0.73	0.82	0.45	29.5
127.792	5.0312	228.600	9.0000	53.975	2.1250	49.428	1.9460	38.100	1.5000	3.6	3.2	HM926749/HM926710	1	430	651	68.1	140	148	217	200	218	7	15.9	3.6	3.2	0.74	0.81	0.45	9.04
128.588	5.0625	206.375	8.1250	47.625	1.8750	47.625	1.8750	34.925	1.3750	3.2	3.2	799/792	1	326	548	45.7	140	146	195	183	194	6	12.7	3.2	3.2	0.46	1.31	0.72	5.82
130	—	180	—	32	—	32	—	25	—	2	1.5	32926JR	1	200	368	31.4	140	141	171	165	174	6	7	2	1.5	0.34	1.77	0.97	2.42
	—	200	—	45	—	45	—	34	—	2.5	2	32026JR	1	340	563	42.9	142	144	190	178	192	8	11	2	2	0.43	1.38	0.76	5.04
	—	200	—	55	—	55	—	43	—	2.5	2	33026JR	1	390	705	42.5	142	143	190	178	192	8	12	2	2	0.34	1.76	0.97	6.19
130.000	5.1181	206.375	8.1250	47.625	1.8750	47.625	1.8750	34.925	1.3750	3.6	3.2	797/792	1	326	548	45.7	143	146	195	183	194	6	12.7	3.6	3.2	0.46	1.31	0.72	5.71
130	—	230	—	43.75	—	40	—	34	—	4	3	30226JR	1	377	511	46.2	148	152	216	203	218	7	9.5	3	2.5	0.44	1.38	0.76	7.24
	—	230	—	67.75	—	64	—	54	—	4	3	32226JR	1	554	830	56.0	148	146	216	193	219	7	13.5	3	2.5	0.44	1.38	0.76	11.5
	—	280	—	63.75	—	58	—	49	—	5	4	30326JR	1	657	834	54.0	152	164	262	239	255	8	14.5	4	3	0.35	1.74	0.96	18.1
	—	280	—	72	—	66	—	44	—	5	4	31326JR	1	589	748	87.3	152	155	262	236	261	7	23	4	3	0.83	0.73	0.40	18.9
133.350	5.2500	177.008	6.9688	25.400	1.0000	26.195	1.0313	20.638	0.8125	1.6	1.6	L327249/L327210	1	141	278	29.1	142	145	168	164	169	5.4	4.8	1.6	1.6	0.35	1.72	0.95	1.69
	5.2500	190.500	7.5000	39.688	1.5625	39.688	1.5625	33.338	1.3125	3.6	3.2	48385/48320	1	236	472	35.9	146	150	179	174	181	4.7	6.4	3.6	3.2	0.32	1.87	1.03	3.58
	5.2500	196.850	7.7500	46.038	1.8125	46.038	1.8125	38.100	1.5000	7.9	3.2	67391/67322	1	311	561	39.7	155	148	185	180	188	5	7.9	7.9	3.2	0.34	1.74	0.96	4.55
	5.2500	215.900	8.5000	47.625	1.8750	47.625	1.8750	34.925	1.3750	3.6	3.2	74525/74850	1	322	549	49.7	146	156	204	193	204	5	12.7	3.6	3.2	0.49	1.23	0.68	6.35
	5.2500	234.950	9.2500	63.500	2.5000	63.500	2.5000	49.213	1.9375	9.5	3.2	95525/95925	1	523	826	49.9	158	155	223	204	216	8	14.3	9.5	3.2	0.37	1.62	0.89	11.0
136.525	5.3750	190.500	7.5000	39.688	1.5625	39.688	1.5625	33.338	1.3125	3.6	3.2	48393/48320	1	236	472	35.9	149	150	179	174	181	4.7	6.4	3.6	3.2	0.32	1.87	1.03	3.37
	5.3750	228.600	9.0000	57.150	2.2500	57.150	2.2500	44.450	1.7500	3.6	3.2	896/892	1	439	730	50.6	149	158	217	201	214	6	12.7	3.6	3.2	0.42	1.43	0.78	8.98
139.700	5.5000	215.900	8.5000	47.625	1.8750	47.625	1.8750	34.925	1.3750	3.6	3.2	74550/74850	1	322	549	49.7	152	156	204	193	204	5	12.7	3.6	3.2	0.49	1.23	0.68	5.84
	5.5000	215.900	8.5000	47.625	1.8750	47.625	1.8750	34.925	1.3750	6.4	3.2	74550A/74850	1	322	549	49.7	158	156	204	193	204	5	12.7	6.4	3.2	0.49	1.23	0.68	5.82
	5.5000	228.600	9.0000	57.150	2.2500	57.150	2.2500	44.450	1.7500	3.6	3.2	898/892	1	439	730	50.6	152	158	217	201	214	6	12.7	3.6	3.2	0.42	1.43	0.78	8.68

[Note] 1) While metric series bearings have minus tolerances for bore and OD, inch series have plus tolerances. Refer to page 190 for details of applicable tolerance standards.

# Single-row tapered roller bearings

*d* (139.700) ~ (150) mm

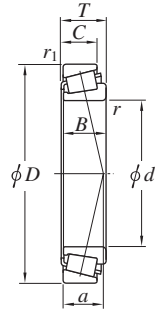

Design 1



Design 1-P

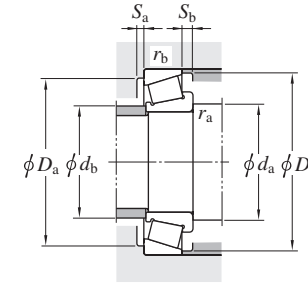

Boundary dimensions						Bearing No. <sup>1)</sup>	De- sign	Basic load ratings (kN)		Load center (mm) <i>a</i>	Mounting dimensions (mm)								Constant <i>e</i>	Axial load factors		(Refer.) Mass (kg)							
<i>d</i> mm	<i>D</i> mm		<i>T</i> mm		<i>B</i> mm			<i>C</i> mm			<i>C<sub>r</sub></i>	<i>C<sub>0r</sub></i>	<i>d<sub>a</sub></i>	<i>d<sub>b</sub></i>	<i>D<sub>a</sub></i>		<i>D<sub>b</sub></i>			<i>S<sub>a</sub></i>	<i>S<sub>b</sub></i>		<i>r<sub>a</sub></i>	<i>r<sub>b</sub></i>	<i>Y<sub>1</sub></i>	<i>Y<sub>0</sub></i>			
	1/25.4	1/25.4	1/25.4	1/25.4	1/25.4			1/25.4	1/25.4	1/25.4			min.	max.	min.	max.	min.	min.	min.	min.	max.	max.							
<b>139.700</b>	5.5000	228.600	9.0000	57.150	2.2500	57.150	2.2500	44.450	1.7500	6.4	3.2	<b>898A/892</b>	1	439	730	50.6	158	158	217	201	214	6	12.7	6.4	3.2	0.42	1.43	0.78	8.66
	5.5000	236.538	9.3125	57.150	2.2500	56.642	2.2300	44.450	1.7500	3.6	3.2	<b>HM231132/HM231110</b>	1	499	832	45.2	152	168	225	213	222	8	12.7	3.6	3.2	0.32	1.88	1.04	10.1
	5.5000	254.000	10.0000	66.675	2.6250	66.675	2.6250	47.625	1.8750	7.1	3.2	<b>99550/99100</b>	1	549	913	55.0	159	174	242	223	236	8	19.1	7.1	3.2	0.41	1.47	0.81	14.1
	5.5000	295.275	11.6250	82.550	3.2500	87.313	3.4375	57.150	2.2500	9.5	6.4	<b>HH231649/HH231615</b>	1	814	1 090	56.3	164	176	277	252	264	11	25.4	9.5	6.4	0.32	1.88	1.04	24.9
<b>140</b>	—	190	—	32	—	32	—	25	—	2	1.5	<b>32928JR</b>	1	206	390	33.6	150	150	181	174	184	6	7	2	1.5	0.36	1.67	0.92	2.57
	—	210	—	45	—	45	—	34	—	2.5	2	<b>32028JR</b>	1	346	585	45.6	152	153	200	187	202	8	11	2	2	0.46	1.31	0.72	5.28
	—	210	—	56	—	56	—	44	—	2.5	2	<b>33028JR</b>	1	406	758	45.6	152	152	200	186	202	7	12	2	2	0.36	1.67	0.92	6.61
<b>140.000</b>	5.5118	215.000	8.4646	47.625	1.8750	47.625	1.8750	34.925	1.3750	3.6	3.2	<b>74551X/74846X</b>	1	322	549	49.7	153	156	203	193	204	5	12.7	3.6	3.2	0.49	1.23	0.68	5.74
<b>140</b>	—	250	—	71.75	—	68	—	58	—	4	3	<b>32228JR</b>	1	636	961	60.0	158	158	236	210	238	9	13.5	3	2.5	0.44	1.38	0.76	14.7
	—	300	—	77	—	70	—	47	—	5	4	<b>31328JR</b>	1	674	865	93.8	162	167	282	254	280	8	26	4	3	0.83	0.73	0.40	23.3
<b>142.875</b>	5.6250	193.675	7.6250	28.575	1.1250	28.575	1.1250	23.020	0.9063	1.6	1.6	<b>36686/36620</b>	1	187	375	33.7	152	158	185	179	185	5.5	5.6	1.6	1.6	0.37	1.63	0.90	2.41
	5.6250	200.025	7.8750	41.275	1.6250	39.688	1.5625	34.130	1.3437	3.6	3.3	<b>48685/48620</b>	1	246	491	38.4	156	157	188	182	190	4	7.1	3.6	3.3	0.34	1.78	0.98	3.84
	5.6250	222.250	8.7500	34.925	1.3750	31.623	1.2450	23.813	0.9375	3.6	3.2	<b>73562/73875</b>	1	209	302	41.9	156	163	210	197	204	4	11.1	3.6	3.2	0.44	1.37	0.75	4.15
	5.6250	241.300	9.5000	57.150	2.2500	56.642	2.2300	44.450	1.7500	3.6	3.2	<b>HM231136/HM231115</b>	1	499	832	45.2	156	168	229	213	222	8	12.7	3.6	3.2	0.32	1.88	1.04	10.4
<b>146.050</b>	5.7500	193.675	7.6250	28.575	1.1250	28.575	1.1250	23.020	0.9063	1.6	1.6	<b>36690/36620</b>	1	187	375	33.7	155	158	185	179	185	5.5	5.6	1.6	1.6	0.37	1.63	0.90	2.25
	5.7500	193.675	7.6250	28.575	1.1250	28.575	1.1250	23.020	0.9063	4.8	1.6	<b>36691/36620</b>	1	187	375	33.7	161	158	185	179	185	5.5	5.6	4.8	1.6	0.37	1.63	0.90	2.23
	5.7500	236.538	9.3125	57.150	2.2500	56.642	2.2300	44.450	1.7500	3.6	3.2	<b>HM231140/HM231110</b>	1	499	832	45.2	159	168	225	213	222	8	12.7	3.6	3.2	0.32	1.88	1.04	9.45
	5.7500	241.300	9.5000	57.150	2.2500	56.642	2.2300	44.450	1.7500	3.6	3.2	<b>82576/82950</b>	1	419	728	53.4	159	169	229	211	224	7	12.7	3.6	3.2	0.44	1.36	0.75	10.0
	5.7500	268.288	10.5625	74.613	2.9375	74.613	2.9375	57.150	2.2500	6.4	6.4	<b>EE107057/107105</b>	1	658	1 050	59.4	164	178	250	234	249	8	17.5	6.4	6.4	0.39	1.55	0.85	17.9
5.7500	304.800	12.0000	88.900	3.5000	82.550	3.2500	57.150	2.2500	6.4	6.4	<b>HH932145/HH932110</b>	1	791	1 060	92.1	164	178	287	259	287	7	31.8	6.4	6.4	0.73	0.82	0.45	26.9	
<b>149.225</b>	5.8750	236.538	9.3125	57.150	2.2500	56.642	2.2300	44.450	1.7500	3.6	3.2	<b>82587/82931</b>	1	419	728	53.4	162	169	225	211	224	7	12.7	3.6	3.2	0.44	1.36	0.75	9.07
	5.8750	236.538	9.3125	57.150	2.2500	56.642	2.2300	44.450	1.7500	6.4	3.2	<b>HM231148/HM231110</b>	1	499	832	45.2	167	168	225	213	222	8	12.7	6.4	3.2	0.32	1.88	1.04	9.10
	5.8750	236.538	9.3125	57.150	2.2500	56.642	2.2300	44.450	1.7500	3.6	3.2	<b>HM231149/HM231110</b>	1	499	832	45.2	162	168	225	213	222	8	12.7	3.6	3.2	0.32	1.88	1.04	9.13
<b>150</b>	—	210	—	38	—	38	—	30	—	2.5	2	<b>32930JR</b>	1	286	536	36.1	162	163	200	194	202	7	8	2	2	0.33	1.83	1.01	3.96
	—	225	—	48	—	48	—	36	—	3	2.5	<b>32030JR</b>	1	391	668	48.8	164	164	213	200	216	8	12	2.5	2	0.46	1.31	0.72	6.41

[Note] 1) While metric series bearings have minus tolerances for bore and OD, inch series have plus tolerances. Refer to page 190 for details of applicable tolerance standards.

# Single-row tapered roller bearings

$d$  (150) ~ (168.275) mm

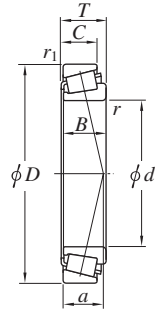

Design 1



Design 1-P

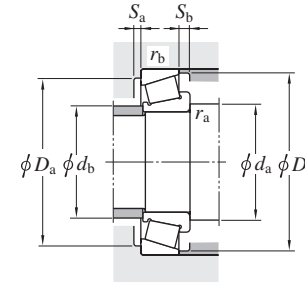

Boundary dimensions							Bearing No. 1)	De- sign	Basic load ratings (kN)		Load center (mm)	Mounting dimensions (mm)								Con- stant e	Axial load factors		(Refer.) Mass (kg)						
d	D		T		B				C			r	r <sub>1</sub>	C <sub>r</sub>	C <sub>0r</sub>	d <sub>a</sub>	d <sub>b</sub>	D <sub>a</sub>			D <sub>b</sub>			S <sub>a</sub>	S <sub>b</sub>	r <sub>a</sub>	r <sub>b</sub>	Y <sub>1</sub>	Y <sub>0</sub>
mm	1/25.4	mm	1/25.4	mm	1/25.4	mm			1/25.4	mm	1/25.4	min.	min.			min.	max.	max.	min.	min.	min.	min.	max.	max.					
150	—	225	—	59	—	59	—	46	—	3	2.5	33030JR	1	459	869	47.8	164	164	213	200	217	8	13	2.5	2	0.36	1.65	0.90	8.09
	—	270	—	77	—	73	—	60	—	4	3	32230JR	1	704	1 070	65.2	168	170	256	226	254	8	17	3	2.5	0.44	1.38	0.76	18.2
	—	320	—	82	—	75	—	50	—	5	4	31330JR	1	763	989	100.1	172	179	302	272	301	9	27	4	3	0.83	0.73	0.40	28.0
152.400	6.0000	254.000	10.0000	66.675	2.6250	66.675	2.6250	47.625	1.8750	7.1	3.2	99600/99100	1	549	913	55.0	172	174	242	223	236	8	19.1	7.1	3.2	0.41	1.47	0.81	12.6
	6.0000	254.000	10.0000	66.675	2.6250	71.438	2.8125	47.625	1.8750	1.6	3.2	99603/99100	1	549	913	55.0	161	174	242	223	236	8	19.1	1.6	3.2	0.41	1.47	0.81	12.8
	6.0000	268.288	10.5625	74.613	2.9375	74.613	2.9375	57.150	2.2500	6.4	6.4	EE107060/107105	1	658	1 050	59.4	171	178	250	234	249	8	17.5	6.4	6.4	0.39	1.55	0.85	17.1
	6.0000	269.799	10.6220	74.612	2.9375	74.613	2.9375	57.150	2.2500	6.4	6.4	EE107060/107107	1	658	1 050	59.4	171	178	252	234	249	8	17.5	6.4	6.4	0.39	1.55	0.85	17.4
	6.0000	307.975	12.1250	88.900	3.5000	93.663	3.6875	61.913	2.4375	9.5	6.7	EE450601/451212	1	795	1 150	61.4	177	193	289	261	274	7	27	9.5	6.7	0.33	1.84	1.01	28.1
	6.0000	307.975	12.1250	88.900	3.5000	93.663	3.6875	66.675	2.6250	9.5	6.7	HH234048/HH234010	1	1 020	1 450	63.3	177	191	289	270	285	8	22.2	9.5	6.7	0.33	1.84	1.01	29.4
	6.0000	317.500	12.5000	88.900	3.5000	93.663	3.6875	66.675	2.6250	9.5	6.7	HH234048/HH234018	1	1 020	1 450	63.3	177	191	299	270	285	8	22.2	9.5	6.7	0.33	1.84	1.01	31.9
155.575	6.1250	330.200	13.0000	85.725	3.3750	79.375	3.1250	53.975	2.1250	6.4	6.4	H936340/H936310	1	868	1 210	103.8	174	196	312	281	311	6	31.8	6.4	6.4	0.81	0.74	0.41	31.4
160	—	220	—	38	—	38	—	30	—	2.5	2	32932JR	1	295	568	38.4	172	173	210	204	212	7	8	2	2	0.35	1.73	0.95	4.19
	—	240	—	51	—	51	—	38	—	3	2.5	32032JR	1	440	758	52.1	174	175	228	213	231	8	13	2.5	2	0.46	1.31	0.72	7.75
	—	290	—	84	—	80	—	67	—	4	3	32232JR	1	795	1 210	70.3	178	182	276	242	274	10	17	3	2.5	0.44	1.38	0.76	23.2
160.325	6.3120	288.925	11.3750	63.500	2.5000	63.500	2.5000	47.625	1.8750	7.1	3.2	HM237532/HM237510	1	628	973	52.2	180	203	277	260	270	8	15.9	7.1	3.2	0.32	1.88	1.04	17.0
161.925	6.3750	374.650	14.7500	87.313	3.4375	79.375	3.1250	60.325	2.3750	6.4	3.2	EE117063/117148	1	876	1 220	103.7	180	218	363	308	337	7	27	6.4	3.2	0.73	0.82	0.45	43.7
165.100	6.5000	247.650	9.7500	47.625	1.8750	47.625	1.8750	38.100	1.5000	3.6	3.2	67780/67720	1	346	701	52.3	178	193	236	226	237	5	9.5	3.6	3.2	0.44	1.36	0.75	7.92
	6.5000	254.000	10.0000	46.038	1.8125	46.038	1.8125	33.338	1.3125	4.8	3.2	M235145/M235113	1	378	620	41.5	180	191	242	232	239	7	12.7	4.8	3.2	0.32	1.88	1.04	7.87
	6.5000	288.925	11.3750	63.500	2.5000	63.500	2.5000	47.625	1.8750	7.1	3.2	HM237535/HM237510	1	628	973	52.2	185	203	277	260	270	8	15.9	7.1	3.2	0.32	1.88	1.04	16.4
	6.5000	288.925	11.3750	63.500	2.5000	63.500	2.5000	47.625	1.8750	7.1	3.2	HM237536/HM237511	1	628	973	52.2	185	203	277	260	270	8	15.9	7.1	3.2	0.32	1.88	1.04	16.4
	6.5000	289.975	11.4163	63.500	2.5000	63.500	2.5000	48.000	1.8898	7.1	3	HM237535/HM237513	1	628	973	52.2	185	203	279	260	270	8	15.5	7.1	3	0.32	1.88	1.04	16.6
	6.5000	336.550	13.2500	92.075	3.6250	95.250	3.7500	69.850	2.7500	3.2	6.4	HH437549/HH437510	1	1 040	1 630	70.7	177	215	318	290	307	12	22.2	3.2	6.4	0.37	1.62	0.89	38.5
	6.5000	360.000	14.1732	92.075	3.6250	88.897	3.4999	63.500	2.5000	9.5	3.2	EE420651/421417	1	938	1 460	75.6	190	243	348	317	334	6	28.6	9.5	3.2	0.40	1.49	0.82	42.9
168.275	6.6250	247.650	9.7500	47.625	1.8750	47.625	1.8750	38.100	1.5000	3.6	3.2	67782/67720	1	346	701	52.3	181	193	236	226	237	5	9.5	3.6	3.2	0.44	1.36	0.75	7.61
	6.6250	330.200	13.0000	85.725	3.3750	79.375	3.1250	53.975	2.1250	6.4	6.4	H936349/H936310	1	868	1 210	103.8	187	196	312	281	311	6	31.8	6.4	6.4	0.81	0.74	0.41	29.5

[Note] 1) While metric series bearings have minus tolerances for bore and OD, inch series have plus tolerances. Refer to page 190 for details of applicable tolerance standards.



Single-row tapered roller bearings

$d$  (168.275) ~ (177.800) mm

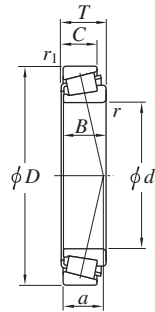

Design 1



Design 1-P

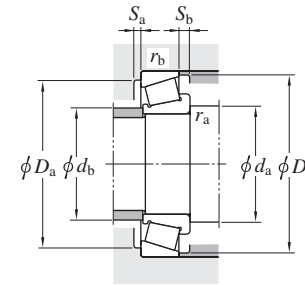

Boundary dimensions						Bearing No. <sup>1)</sup>	De- sign	Basic load ratings (kN)		Load center (mm) a	Mounting dimensions (mm)								Con- stant e	Axial load factors		(Refer.) Mass (kg)							
d	D	T	B	C	r			r1	C <sub>r</sub>		C <sub>0r</sub>	d <sub>a</sub>	d <sub>b</sub>	D <sub>a</sub>	D <sub>b</sub>	S <sub>a</sub>	S <sub>b</sub>	r <sub>a</sub>		r <sub>b</sub>	Y <sub>1</sub>		Y <sub>0</sub>						
mm	mm	mm	mm	mm	mm	mm	mm	mm	mm	mm	mm	mm	mm	mm	mm	mm	mm												
168.275	6.6250	342.900	13.5000	85.725	3.3750	79.375	3.1250	53.975	2.1250	6.4	6.4	H936349/H936316	1	868	1 210	103.8	187	196	325	281	311	6	31.8	6.4	6.4	0.81	0.74	0.41	32.3
170	—	230	—	38	—	38	—	30	—	2.5	2	32934JR	1	296	606	42.0	182	183	220	213	222	7	8	2	2	0.38	1.57	0.86	4.49
170.000	6.6929	230.000	9.0551	39.000	1.5354	38.000	1.4961	31.000	1.2205	3.0	2.5	JHM534149/JHM534110	1	291	558	43.6	181	184	220	214	222	7	8	3.0	2.5	0.38	1.57	0.86	4.46
	6.6929	240.000	9.4488	46.000	1.8110	44.500	1.7520	37.000	1.4567	3.0	2.5	JM734449/JM734410	1	353	666	50.6	181	184	230	220	231	7	9	3.0	2.5	0.44	1.37	0.75	6.31
	6.6929	254.000	10.0000	46.038	1.8125	46.038	1.8125	33.338	1.3125	4.8	3.2	86669/86100	1	336	531	44.9	185	189	242	230	238	6	12.7	4.8	3.2	0.37	1.63	0.90	7.01
	6.6929	254.000	10.0000	46.038	1.8125	46.038	1.8125	33.338	1.3125	4.8	3.2	M235149/M235113	1	378	620	41.5	185	191	242	232	239	7	12.7	4.8	3.2	0.32	1.88	1.04	7.41
170	—	260	—	57	—	57	—	43	—	3	2.5	32034JR	1	526	905	55.8	184	187	248	230	249	10	14	2.5	2	0.44	1.35	0.74	10.5
170.000	6.6929	266.700	10.5000	46.038	1.8125	46.038	1.8125	33.338	1.3125	4.8	1.6	86669/86105	1	336	531	44.9	185	189	258	230	238	6	12.7	4.8	1.6	0.37	1.63	0.90	8.36
171.450	6.7500	288.925	11.3750	63.500	2.5000	63.500	2.5000	47.625	1.8750	7.1	3.2	94675/94113A	1	550	960	63.2	191	204	277	255	269	8	15.9	7.1	3.2	0.47	1.28	0.70	16.2
	6.7500	298.450	11.7500	63.500	2.5000	63.500	2.5000	47.625	1.8750	7.1	3.2	94675/94118	1	550	960	63.2	191	204	287	255	269	8	15.9	7.1	3.2	0.47	1.28	0.70	17.8
174.625	6.8750	247.650	9.7500	47.625	1.8750	47.625	1.8750	38.100	1.5000	3.6	3.2	67787/67720	1	346	701	52.3	187	193	236	226	237	5	9.5	3.6	3.2	0.44	1.36	0.75	6.98
	6.8750	288.925	11.3750	63.500	2.5000	63.500	2.5000	47.625	1.8750	7.1	3.2	94687/94113	1	550	960	63.2	194	204	277	255	269	8	15.9	7.1	3.2	0.47	1.28	0.70	15.8
	6.8750	288.925	11.3750	63.500	2.5000	63.500	2.5000	47.625	1.8750	7.1	3.2	HM237542/HM237510	1	628	973	52.2	194	203	277	260	270	8	15.9	7.1	3.2	0.32	1.88	1.04	15.1
	6.8750	311.150	12.2500	82.550	3.2500	82.550	3.2500	65.088	2.5625	6.4	6.4	H238148/H238110	1	862	1 340	64.3	193	207	293	273	287	8	17.5	6.4	6.4	0.33	1.82	1.00	25.3
177.800	7.0000	227.013	8.9375	30.163	1.1875	30.163	1.1875	23.020	0.9063	1.6	1.6	36990/36920	1	177	402	43.0	186	191	218	212	219	6	7.1	1.6	1.6	0.44	1.36	0.75	2.85
	7.0000	247.650	9.7500	47.625	1.8750	47.625	1.8750	38.100	1.5000	3.6	3.2	67790/67720	1	346	701	52.3	190	193	236	226	237	5	9.5	3.6	3.2	0.44	1.36	0.75	6.65
	7.0000	247.650	9.7500	47.625	1.8750	47.625	1.8750	38.100	1.5000	10.4	3.2	67791/67720	1	346	701	52.3	204	193	236	226	237	5	9.5	10.4	3.2	0.44	1.36	0.75	6.56
	7.0000	260.350	10.2500	53.975	2.1250	53.975	2.1250	41.275	1.6250	3.6	3.2	M236849/M236810	1	442	821	48.4	190	199	249	237	246	5	12.7	3.6	3.2	0.33	1.80	0.99	8.94
	7.0000	285.750	11.2500	63.500	2.5000	63.500	2.5000	41.275	1.6250	6.4	3.2	EE91702/91112	1	443	716	58.8	196	205	274	251	263	4	22.2	6.4	3.2	0.43	1.39	0.77	13.4
	7.0000	288.925	11.3750	63.500	2.5000	63.500	2.5000	47.625	1.8750	7.1	3.2	94700/94113	1	550	960	63.2	197	204	277	255	269	8	15.9	7.1	3.2	0.47	1.28	0.70	15.3
	7.0000	288.925	11.3750	63.500	2.5000	63.500	2.5000	47.625	1.8750	7.1	3.2	94700/94113A	1	550	960	63.2	197	204	277	255	269	8	15.9	7.1	3.2	0.47	1.28	0.70	15.3
	7.0000	288.925	11.3750	63.500	2.5000	63.500	2.5000	47.625	1.8750	7.1	3.2	HM237545/HM237510	1	628	973	52.2	197	203	277	260	270	8	15.9	7.1	3.2	0.32	1.88	1.04	14.7
	7.0000	304.800	12.0000	66.675	2.6250	69.106	2.7207	42.863	1.6875	6.4	3.2	EE280702/281202	1	548	802	54.4	196	211	293	271	281	7	23.8	6.4	3.2	0.36	1.67	0.92	17.3
	7.0000	319.964	12.5970	88.900	3.5000	85.725	3.3750	65.088	2.5625	3.6	4.8	EE222070/222126	1	747	1 220	72.9	190	216	305	280	297	4	23.8	3.6	4.8	0.40	1.49	0.82	28.0

[Note] 1) While metric series bearings have minus tolerances for bore and OD, inch series have plus tolerances. Refer to page 190 for details of applicable tolerance standards.

# Single-row tapered roller bearings

*d* (177.800) ~ 190 mm

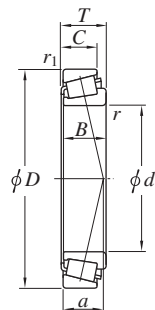

Design 1



Design 1-P

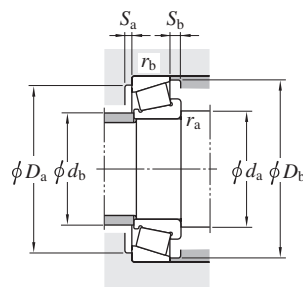

Boundary dimensions										Bearing No. <sup>1)</sup>	De-sign	Basic load ratings (kN)		Load center (mm) <i>a</i>	Mounting dimensions (mm)								Constant <i>e</i>	Axial load factors		(Refer.) Mass (kg)			
<i>d</i>	<i>D</i>		<i>T</i>		<i>B</i>		<i>C</i>		<i>r</i>			<i>r<sub>1</sub></i>	<i>C<sub>r</sub></i>		<i>C<sub>0r</sub></i>	<i>d<sub>a</sub></i>	<i>d<sub>b</sub></i>	<i>D<sub>a</sub></i>		<i>D<sub>b</sub></i>		<i>S<sub>a</sub></i>		<i>S<sub>b</sub></i>	<i>r<sub>a</sub></i>		<i>r<sub>b</sub></i>	<i>Y<sub>1</sub></i>	<i>Y<sub>0</sub></i>
mm	1/25.4	mm	1/25.4	mm	1/25.4	mm	1/25.4	mm	1/25.4			min.	min.				min.	max.	max.	min.	min.	min.		min.	max.		max.		
177.800	7.0000	319.964	12.5970	88.900	3.5000	85.725	3.3750	65.088	2.5625	3.6	4.8	H239640/H239610	1	853	1 270	66.1	190	214	305	286	300	5	23.8	3.6	4.8	0.32	1.88	1.04	26.9
	7.0000	320.675	12.6250	88.900	3.5000	85.725	3.3750	65.088	2.5625	3.6	4.8	EE222070/222128	1	747	1 220	72.9	190	216	306	280	297	4	23.8	3.6	4.8	0.40	1.49	0.82	28.2
	7.0000	327.025	12.8750	90.488	3.5625	92.075	3.6250	63.500	2.5000	6.4	6.4	EE470078/470128	1	864	1 430	68.3	196	225	309	289	305	7	27	6.4	6.4	0.37	1.63	0.90	31.1
	7.0000	336.550	13.2500	90.488	3.5625	92.075	3.6250	63.500	2.5000	13.5	6.4	EE470073/470132	1	864	1 430	68.3	210	225	318	289	305	7	27	13.5	6.4	0.37	1.63	0.90	33.4
	7.0000	360.000	14.1732	92.075	3.6250	88.897	3.4999	63.500	2.5000	12.7	3.2	EE420701/421417	1	938	1 460	75.6	209	243	348	317	334	6	28.6	12.7	3.2	0.40	1.49	0.82	40.5
	7.0000	365.049	14.3720	92.075	3.6250	88.897	3.4999	63.500	2.5000	12.7	3.2	EE420701/421437	1	938	1 460	75.6	209	243	353	317	334	6	28.6	12.7	3.2	0.40	1.49	0.82	41.9
	7.0000	428.625	16.8750	106.362	4.1875	95.250	3.7500	61.912	2.4375	6.4	6.4	EE350701/351687	1	1 070	1 390	118.7	196	238	410	350	381	9	44.5	6.4	6.4	0.76	0.79	0.44	64.6
179.975	7.0856	317.500	12.5000	63.500	2.5000	63.500	2.5000	46.038	1.8125	3.6	3.2	93708/93125	1	604	1 130	71.4	193	227	306	278	294	7	17.5	3.6	3.2	0.52	1.15	0.63	20.8
180	—	250	—	45	—	45	—	34	—	2.5	2	32936JR	1	357	735	53.5	192	193	240	225	241	8	11	2	2	0.48	1.25	0.69	6.64
180.000	7.0866	250.000	9.8425	47.000	1.8504	45.000	1.7717	37.000	1.4567	3.0	2.5	JM736149/JM736110	1	365	705	55.2	191	193	240	230	242	7	10	3.0	2.5	0.48	1.25	0.69	6.56
180	—	280	—	64	—	64	—	48	—	3	2.5	32036JR	1	644	1 100	59.5	194	199	268	247	268	10	16	2.5	2	0.42	1.42	0.78	14.1
	—	320	—	57	—	52	—	43	—	5	4	30236JR	1	615	870	63.6	202	211	302	278	297	9	14	4	3	0.45	1.33	0.73	18.3
	—	320	—	91	—	86	—	71	—	5	4	32236JR	1	957	1 520	77.8	202	204	302	267	303	10	20	4	3	0.45	1.33	0.73	29.9
184.150	7.2500	266.700	10.5000	47.625	1.8750	46.833	1.8438	38.100	1.5000	3.6	3.2	67883/67820	1	339	703	57.8	197	211	255	245	257	6	9.5	3.6	3.2	0.48	1.26	0.69	8.55
	7.2500	279.997	11.0235	46.525	1.8317	46.833	1.8438	36.000	1.4173	3.6	3.2	67883/67830	1	339	703	56.7	197	211	268	245	256	7	10.5	3.6	3.2	0.48	1.26	0.69	10.0
187.325	7.3750	269.875	10.6250	55.563	2.1875	55.563	2.1875	42.863	1.6875	3.6	3.2	M238849/M238810	1	411	805	49.9	200	209	258	245	255	5	12.7	3.6	3.2	0.33	1.80	0.99	9.66
	7.3750	319.964	12.5970	88.900	3.5000	85.725	3.3750	65.088	2.5625	5.6	4.8	H239649/H239610	1	853	1 270	66.1	204	214	305	286	300	5	23.8	5.6	4.8	0.32	1.88	1.04	25.1
	7.3750	320.675	12.6250	88.900	3.5000	85.725	3.3750	65.088	2.5625	5.6	4.8	H239649/H239612	1	853	1 270	66.1	204	214	306	286	300	5	23.8	5.6	4.8	0.32	1.88	1.04	25.3
190	—	260	—	45	—	45	—	34	—	2.5	2	32938JR	1	366	789	55.0	202	204	250	235	252	8	11	2	2	0.48	1.26	0.69	6.89
190.000	7.4803	260.000	10.2362	46.000	1.8110	44.000	1.7323	36.500	1.4370	3.0	2.5	JM738249/JM738210	1	369	723	56.0	201	203	250	240	251	7	9.5	3.0	2.5	0.48	1.26	0.69	6.89
190	—	290	—	64	—	64	—	48	—	3	2.5	32038JR	1	654	1 170	62.9	204	209	278	257	279	10	16	2.5	2	0.44	1.36	0.75	14.7
	—	340	—	60	—	55	—	46	—	5	4	30238JR	1	729	1 030	66.4	212	225	322	298	318	12	13	4	3	0.44	1.38	0.76	21.9
	—	340	—	97	—	92	—	75	—	5	4	32238JR	1	1 090	1 740	81.9	212	216	322	286	323	12	22	4	3	0.44	1.38	0.76	36.6

[Note] 1) While metric series bearings have minus tolerances for bore and OD, inch series have plus tolerances. Refer to page 190 for details of applicable tolerance standards.

d 190.500 ~ (203.200) mm

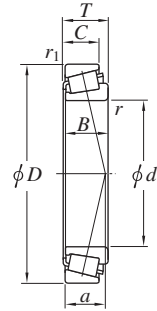

Design 1



Design 1-P

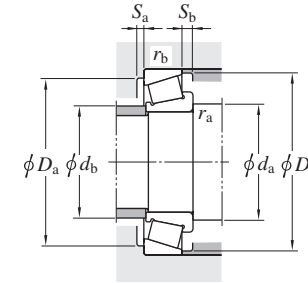

Boundary dimensions								Bearing No. <sup>1)</sup>	De-sign	Basic load ratings (kN)		Load center (mm)	Mounting dimensions (mm)								Constant e	Axial load factors		(Refer.) Mass (kg)					
d	D		T		B		C			r	r <sub>1</sub>		C <sub>r</sub>	C <sub>0r</sub>	a	d <sub>a</sub> min.	d <sub>b</sub> max.	D <sub>a</sub> max.	D <sub>b</sub> min.	S <sub>a</sub> min.		S <sub>b</sub> min.	r <sub>a</sub> max.		r <sub>b</sub> max.	Y <sub>1</sub>	Y <sub>0</sub>		
mm	1/25.4	mm	1/25.4	mm	1/25.4	mm	1/25.4			mm	1/25.4	min.	min.			min.	max.	max.	min.	min.	min.	max.	max.						
190.500	7.5000	266.700	10.5000	47.625	1.8750	46.833	1.8438	38.100	1.5000	3.6	3.2	67885/67820	1	339	703	57.8	203	211	255	245	257	6	9.5	3.6	3.2	0.48	1.26	0.69	7.88
	7.5000	282.575	11.1250	50.800	2.0000	47.625	1.8750	36.512	1.4375	3.6	3.2	87750/87111	1	410	726	55.7	203	215	271	256	266	3	14.3	3.6	3.2	0.42	1.44	0.79	9.67
	7.5000	317.500	12.5000	63.500	2.5000	63.500	2.5000	46.038	1.8125	4.3	3.2	93750/93125	1	604	1130	71.4	205	227	306	278	294	7	17.5	4.3	3.2	0.52	1.15	0.63	19.3
	7.5000	317.500	12.5000	68.263	2.6875	63.500	2.5000	50.800	2.0000	4.3	3.2	93750/93126	1	604	1130	76.2	205	227	306	276	294	2	17.5	4.3	3.2	0.52	1.15	0.63	20.3
	7.5000	336.550	13.2500	98.425	3.8750	95.250	3.7500	73.025	2.8750	6.4	6.4	HH840249/HH840210	1	956	1710	93.5	209	217	318	288	316	8	25.4	6.4	6.4	0.58	1.04	0.57	35.8
	7.5000	368.300	14.5000	92.075	3.6250	88.897	3.4999	63.500	2.5000	6.4	3.2	EE420751/421450	1	938	1460	75.6	209	243	356	317	334	6	28.6	6.4	3.2	0.40	1.49	0.82	40.4
	7.5000	428.625	16.8750	106.363	4.1875	95.250	3.7500	61.913	2.4375	6.4	6.4	EE350750/351687	1	1070	1390	118.7	209	238	410	350	381	9	44.5	6.4	6.4	0.76	0.79	0.44	62.0
193.675	7.6250	282.575	11.1250	50.800	2.0000	47.625	1.8750	36.512	1.4375	3.6	3.2	87762/87111	1	410	726	55.7	206	215	271	256	266	3	14.3	3.6	3.2	0.42	1.44	0.79	9.32
196.850	7.7500	254.000	10.0000	28.575	1.1250	27.783	1.0938	21.433	0.8438	1.6	1.6	L540049/L540010	1	188	387	43.1	206	214	245	238	243	4	7.1	1.6	1.6	0.40	1.51	0.83	3.35
	7.7500	257.175	10.1250	39.688	1.5625	39.688	1.5625	30.163	1.1875	3.6	3.2	LM739749/LM739710	1	268	632	50.6	210	211	245	238	247	6	9.5	3.6	3.2	0.45	1.34	0.74	5.27
	7.7500	266.700	10.5000	39.688	1.5625	39.688	1.5625	30.163	1.1875	3.6	3.2	LM739749/LM739719	1	268	632	50.6	210	211	255	238	247	6	9.5	3.6	3.2	0.45	1.34	0.74	6.18
	7.7500	317.500	12.5000	63.500	2.5000	63.500	2.5000	46.038	1.8125	4.3	3.2	93775/93125	1	604	1130	71.4	211	227	306	278	294	7	17.5	4.3	3.2	0.52	1.15	0.63	18.4
	7.7500	317.500	12.5000	68.263	2.6875	63.500	2.5000	50.800	2.0000	4.3	3.2	93775/93126	1	604	1130	76.2	211	227	306	276	294	2	17.5	4.3	3.2	0.52	1.15	0.63	19.3
200	—	280	—	51	—	51	—	39	—	3	2.5	32940JR	1	486	958	53.6	214	216	268	257	271	9	12	2.5	2	0.39	1.52	0.84	9.44
200.000	7.8740	300.000	11.8110	65.000	2.5591	62.000	2.4409	51.000	2.0079	3.6	2.5	JHM840449/JHM840410	1	617	1140	72.1	213	218	290	270	288	6	14	3.6	2.5	0.52	1.15	0.63	15.0
200	—	310	—	70	—	70	—	53	—	3	2.5	32040JR	1	755	1340	66.9	214	221	298	273	297	11	17	2.5	2	0.43	1.39	0.77	19.1
	—	360	—	64	—	58	—	48	—	5	4	30240JR	1	792	1120	70.3	222	238	342	315	336	12	15	4	3	0.44	1.38	0.76	26.4
	—	360	—	104	—	98	—	82	—	5	4	32240JR	1	1240	1880	84.6	222	225	342	302	340	11	22	4	3	0.41	1.48	0.81	44.2
200.025	7.8750	276.225	10.8750	42.863	1.6875	46.038	1.8125	34.133	1.3438	3.6	3.2	LM241147/LM241110	1	375	715	46.3	214	222	263	257	264	4	8.7	3.6	3.2	0.32	1.88	1.04	7.57
	7.8750	292.100	11.5000	57.945	2.2813	57.945	2.2813	46.038	1.8125	3.6	3.2	M241543/M241510	1	545	1030	52.6	214	223	279	267	277	7	11.9	3.6	3.2	0.33	1.80	0.99	12.1
	7.8750	317.500	12.5000	63.500	2.5000	63.500	2.5000	46.038	1.8125	4.3	3.2	93787/93125	1	604	1130	71.4	215	227	305	278	294	7	17.5	4.3	3.2	0.52	1.15	0.63	17.9
	7.8750	355.600	14.0000	69.850	2.7500	69.850	2.7500	49.213	1.9375	6.7	1.6	EE130787/131400	1	727	1310	59.9	220	263	346	319	330	9	20.6	6.7	1.6	0.33	1.82	1.00	28.7
	7.8750	384.175	15.1250	112.713	4.4375	112.712	4.4375	90.488	3.5625	6.4	6.4	H247535/H247510	1-P	1450	2680	83.8	219	265	365	341	361	8	22.2	6.4	6.4	0.33	1.80	0.99	60.5
	7.8750	393.700	15.5000	111.125	4.3750	111.125	4.3750	84.138	3.3125	6.4	6.4	HH144642/HH144614	1	1360	2260	76.2	219	257	374	338	355	9	27	6.4	6.4	0.30	2.02	1.11	59.2
203.200	8.0000	276.225	10.8750	42.863	1.6875	42.863	1.6875	34.133	1.3438	3.6	3.2	LM241149/LM241110	1	375	715	46.3	217	222	263	257	264	4	8.7	3.6	3.2	0.32	1.88	1.04	7.08

[Note] 1) While metric series bearings have minus tolerances for bore and OD, inch series have plus tolerances. Refer to page 190 for details of applicable tolerance standards.

Single-row tapered roller bearings

d (203.200) ~ 220 mm

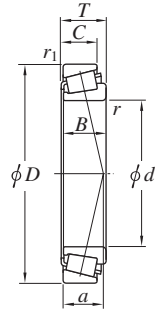

Design 1



Design 1-P

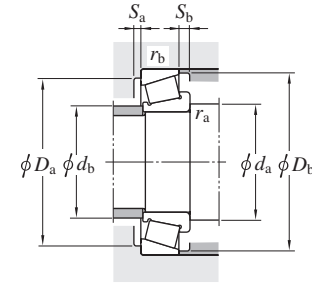

Boundary dimensions								Bearing No. <sup>1)</sup>	De- sign	Basic load ratings (kN)		Load center (mm) a	Mounting dimensions (mm)								Con- stant e	Axial load factors		(Refer.) Mass (kg)					
d	D		T		B		C			r	r <sub>1</sub>		C <sub>r</sub>	C <sub>0r</sub>	d <sub>a</sub>	d <sub>b</sub>	D <sub>a</sub>		D <sub>b</sub>			S <sub>a</sub>	S <sub>b</sub>		r <sub>a</sub>	r <sub>b</sub>	Y <sub>1</sub>	Y <sub>0</sub>	
mm	1/25.4	mm	1/25.4	mm	1/25.4	mm	1/25.4	mm	1/25.4	min.	min.			min.	max.	max.	min.	min.	min.	min.	max.	max.							
203.200	8.0000	279.400	11.0000	46.038	1.8125	46.038	1.8125	36.513	1.4375	3.6	3.2	67983/67919	1	349	707	61.6	217	222	267	259	271	7	9.5	3.6	3.2	0.51	1.18	0.65	8.04
	8.0000	282.575	11.1250	46.038	1.8125	46.038	1.8125	36.513	1.4375	3.6	3.2	67983/67920	1	349	707	61.6	217	222	270	259	271	7	9.5	3.6	3.2	0.51	1.18	0.65	8.43
	8.0000	292.100	11.5000	57.945	2.2813	57.945	2.2813	46.038	1.8125	3.6	3.2	M241547/M241510	1	545	1 030	52.6	217	223	279	267	277	7	11.9	3.6	3.2	0.33	1.80	0.99	11.7
	8.0000	317.500	12.5000	53.975	2.1250	53.975	2.1250	34.925	1.3750	4	3.2	EE132083/132125	1	439	724	48.4	218	238	305	285	292	7	19.1	4	3.2	0.31	1.91	1.05	13.9
	8.0000	317.500	12.5000	63.500	2.5000	63.500	2.5000	46.038	1.8125	4.3	3.2	93800/93125	1	604	1 130	71.4	218	227	305	278	294	7	17.5	4.3	3.2	0.52	1.15	0.63	17.4
	8.0000	317.500	12.5000	63.500	2.5000	63.500	2.5000	46.038	1.8125	7.9	3.2	93800A/93125	1	604	1 130	71.4	225	227	305	278	294	7	17.5	7.9	3.2	0.52	1.15	0.63	17.3
	8.0000	360.000	14.1732	92.075	3.6250	88.897	3.4999	63.500	2.5000	3.2	3.2	EE420801/421417	1	938	1 460	75.6	216	243	347	317	334	6	28.6	3.2	3.2	0.40	1.49	0.82	35.4
	8.0000	368.300	14.5000	92.075	3.6250	88.897	3.4999	63.500	2.5000	3.2	3.2	EE420801/421450	1	938	1 460	75.6	216	243	355	317	334	6	28.6	3.2	3.2	0.40	1.49	0.82	37.8
	8.0000	406.400	16.0000	92.075	3.6250	85.725	3.3750	57.150	2.2500	6.4	6.4	EE114080/114160	1	950	1 460	119.8	222	253	387	337	367	6	34.9	6.4	6.4	0.79	0.76	0.42	48.5
8.0000	482.600	19.0000	117.475	4.6250	95.250	3.7500	73.025	2.8750	6.4	6.4	EE380080/380190	1-P	1 450	2 060	152.8	222	273	463	385	427	1	44.5	6.4	6.4	0.87	0.69	0.38	93.5	
203.987	8.0310	276.225	10.8750	42.863	1.6875	46.038	1.8125	34.132	1.3438	3.6	3.2	LM241148/LM241111	1	375	715	46.3	218	222	263	257	264	4	8.7	3.6	3.2	0.32	1.88	1.04	7.12
204.788	8.0625	292.100	11.5000	57.945	2.2813	57.945	2.2813	46.038	1.8125	3.6	3.2	M241549/M241510	1	545	1 030	52.6	218	223	279	267	277	7	11.9	3.6	3.2	0.33	1.80	0.99	11.5
206.375	8.1250	282.575	11.1250	46.038	1.8125	46.038	1.8125	36.513	1.4375	3.6	3.2	67985/67920	1	349	707	61.6	220	222	270	259	271	7	9.5	3.6	3.2	0.51	1.18	0.65	8.07
	8.1250	317.500	12.5000	53.975	2.1250	53.975	2.1250	34.925	1.3750	4	3.2	EE132084/132125	1	439	724	48.4	221	238	305	285	292	7	19.1	4	3.2	0.31	1.91	1.05	13.4
	8.1250	319.088	12.5625	53.975	2.1250	53.975	2.1250	34.925	1.3750	4	3.2	EE132084/132127	1	439	724	48.4	221	238	306	285	292	7	19.1	4	3.2	0.31	1.91	1.05	13.6
	8.1250	336.550	13.2500	98.425	3.8750	100.013	3.9375	77.788	3.0625	3.2	3.2	H242649/H242610	1	1 040	1 900	73.8	219	236	324	300	317	9	20.6	3.2	3.2	0.33	1.80	0.99	33.1
209.550	8.2500	317.500	12.5000	63.500	2.5000	63.500	2.5000	46.038	1.8125	4.3	3.2	93825/93125	1	604	1 130	71.4	225	227	305	278	294	7	17.5	4.3	3.2	0.52	1.15	0.63	16.4
	8.2500	317.500	12.5000	63.500	2.5000	63.500	2.5000	46.038	1.8125	12.7	3.2	93825A/93125	1	604	1 130	71.4	241	227	305	278	294	7	17.5	12.7	3.2	0.52	1.15	0.63	16.2
	8.2500	333.375	13.1250	69.850	2.7500	69.850	2.7500	52.388	2.0625	6.4	6.4	HM743345/HM743310	1	750	1 330	71.9	229	243	314	301	316	7	17.5	6.4	6.4	0.44	1.37	0.75	22.2
	8.2500	355.600	14.0000	68.263	2.6875	66.675	2.6250	47.625	1.8750	7.1	3.2	96825/96140	1	658	1 320	84.9	230	259	343	312	331	8	20.6	7.1	3.2	0.59	1.02	0.56	26.9
215.900	8.5000	288.925	11.3750	46.038	1.8125	46.038	1.8125	34.925	1.3750	3.6	3.2	LM742749/LM742714	1	356	781	60.7	230	232	276	265	276	6	11.1	3.6	3.2	0.48	1.25	0.69	7.94
	8.5000	360.000	14.1732	82.550	3.2500	79.372	3.1249	63.500	2.5000	1.6	3.2	EE420850/421417	1	938	1 460	75.7	226	243	347	317	334	6	19.1	1.6	3.2	0.40	1.49	0.82	30.9
220	—	300	—	51	—	51	—	39	—	3	2.5	32944JR	1	498	1 010	58.6	234	234	288	275	290	9	12	2.5	2	0.43	1.41	0.78	10.1
	—	340	—	76	—	76	—	57	—	4	3	32044JR	1	894	1 620	72.8	238	243	326	300	326	12	19	3	2.5	0.43	1.39	0.77	25.2
	—	400	—	72	—	65	—	54	—	5	4	30244JR	1	1 010	1 440	76.5	242	263	382	344	371	14	17	4	3	0.44	1.43	0.79	35.9

[Note] 1) While metric series bearings have minus tolerances for bore and OD, inch series have plus tolerances. Refer to page 190 for details of applicable tolerance standards.

# Single-row tapered roller bearings

d 220.663 ~ 237.330 mm

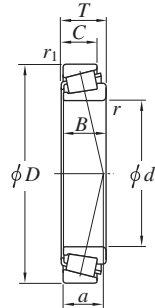

Design 1



Design 1-P

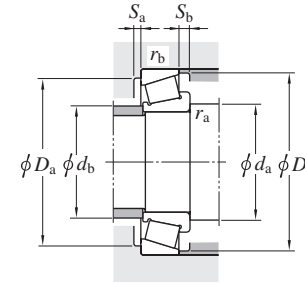

Boundary dimensions										Bearing No. <sup>1)</sup>	De- sign	Basic load ratings (kN)		Load center (mm)	Mounting dimensions (mm)								Con- stant <i>e</i>	Axial load factors		(Refer.) Mass (kg)
<i>d</i>	<i>D</i>	<i>T</i>	<i>B</i>	<i>C</i>	<i>r</i>	<i>r</i> <sub>1</sub>	<i>C</i> <sub>r</sub>	<i>C</i> <sub>0r</sub>	<i>d</i> <sub>a</sub>			<i>d</i> <sub>b</sub>	<i>D</i> <sub>a</sub>		<i>D</i> <sub>b</sub>	<i>S</i> <sub>a</sub>	<i>S</i> <sub>b</sub>	<i>r</i> <sub>a</sub>	<i>r</i> <sub>b</sub>	<i>Y</i> <sub>1</sub>	<i>Y</i> <sub>0</sub>					
mm	mm	mm	mm	mm	mm	mm	min.	min.	min.			max.	min.	min.	min.	min.	max.	max.								
220.663	8.6875 314.325	12.3750 61.913	2.4375 61.913	49.213	1.9375 6.4	3.2	1220	58.0	240	243	301	288	299	5	12.7	6.4	3.2	0.33	1.80	0.99	14.5					
220.878	8.6960 317.500	12.5000 47.625	1.8750 52.388	36.513	1.4375 3.2	3.2	928	50.5	234	253	305	296	304	8	11.1	3.2	3.2	0.33	1.80	0.99	12.3					
223.838	8.8125 295.275	11.6250 46.038	1.8125 46.038	34.925	1.3750 3.6	3.2	792	63.1	237	239	282	273	285	6	11.1	3.6	3.2	0.50	1.20	0.66	8.01					
225.425	8.8750 355.600	14.0000 69.850	2.7500 69.850	49.213	1.9375 6.7	1.6	1310	59.9	245	263	346	319	330	9	20.6	6.7	1.6	0.33	1.82	1.00	24.1					
	8.8750 400.050	15.7500 88.900	3.5000 87.313	63.500	2.5000 1.6	3.2	1600	82.6	235	267	387	344	363	8	25.4	1.6	3.2	0.44	1.37	0.75	42.5					
228.600	9.0000 355.600	14.0000 68.263	2.6875 66.675	47.625	1.8750 6.7	1.6	1320	84.9	249	259	343	312	331	8	20.6	7.1	3.2	0.59	1.02	0.56	23.5					
	9.0000 355.600	14.0000 69.850	2.7500 69.850	49.213	1.9375 6.7	1.6	1310	59.9	248	263	346	319	330	9	20.6	6.7	1.6	0.33	1.82	1.00	23.5					
	9.0000 355.600	14.0000 69.850	2.7500 69.850	50.800	2.0000 6.4	6.4		77.0	248	261	336	322	338	8	19.1	6.4	6.4	0.47	1.27	0.70	24.0					
	9.0000 358.775	14.1250 71.438	2.8125 71.438	53.975	2.1250 3.6	3.2		64.4	242	279	346	330	342	8	17.5	3.6	3.2	0.33	1.80	0.99	26.6					
	9.0000 400.050	15.7500 88.900	3.5000 87.313	63.500	2.5000 10.4	3.2		82.6	256	267	387	344	363	8	25.4	10.4	3.2	0.44	1.37	0.75	41.6					
	9.0000 425.450	16.7500 101.600	4.0000 95.250	76.200	3.0000 7.1	6.4		81.1	249	285	406	364	381	6	25.4	7.1	6.4	0.33	1.80	0.99	58.7					
	9.0000 508.000	20.0000 117.475	4.6250 95.250	73.025	2.8750 6.4	6.4		168.1	248	303	489	410	455	1	44.5	6.4	6.4	0.94	0.64	0.35	97.1					
231.775	9.1250 295.275	11.6250 33.338	1.3125 31.750	23.813	0.9375 3.6	3.2	491	50.1	245	248	282	277	283	4	9.5	3.6	3.2	0.40	1.49	0.82	4.84					
	9.1250 300.038	11.8125 33.338	1.3125 31.750	23.813	0.9375 3.6	3.2	491	50.1	245	248	287	277	283	4	9.5	3.6	3.2	0.40	1.49	0.82	5.25					
	9.1250 377.825	14.8750 79.375	3.1250 80.963	58.738	2.3125 3.2	3.2	1630	77.6	245	266	365	336	353	10	20.6	3.2	3.2	0.43	1.40	0.77	32.9					
234.950	9.2500 314.325	12.3750 49.213	1.9375 49.213	36.513	1.4375 3.6	3.2	981	57.5	249	253	301	293	303	9	12.7	3.6	3.2	0.40	1.51	0.83	10.2					
	9.2500 317.500	12.5000 49.213	1.9375 49.213	36.513	1.4375 3.6	3.2	981	57.5	249	253	305	293	303	9	12.7	3.6	3.2	0.40	1.51	0.83	10.6					
	9.2500 327.025	12.8750 52.388	2.0625 52.388	36.513	1.4375 6.4	3.2	930	60.0	254	259	314	299	309	7	15.9	6.4	3.2	0.41	1.48	0.81	12.2					
	9.2500 327.025	12.8750 52.388	2.0625 52.388	36.513	1.4375 6.4	3.2	930	60.0	254	259	314	299	309	7	15.9	6.4	3.2	0.41	1.48	0.81	12.2					
	9.2500 328.625	12.9380 52.388	2.0625 52.388	36.513	1.4375 6.4	3.2	930	60.0	254	259	316	299	309	7	15.9	6.4	3.2	0.41	1.48	0.81	12.4					
	9.2500 381.000	15.0000 74.613	2.9375 74.613	57.150	2.2500 6.4	3.2	1670	69.0	254	295	368	350	363	6	17.5	6.4	3.2	0.33	1.80	0.99	32.5					
	9.2500 384.175	15.1250 112.713	4.4375 112.712	90.488	3.5625 6.4	6.4		83.8	254	265	365	341	361	8	22.2	6.4	6.4	0.33	1.80	0.99	50.0					
	9.2500 508.000	20.0000 117.475	4.6250 95.250	73.025	2.8750 6.4	6.4		168.1	248	303	489	410	455	1	44.5	6.4	6.4	0.94	0.64	0.35	97.1					
237.330	9.3437 336.550	13.2500 65.088	2.5625 65.088	50.800	2.0000 6.4	3.2	1380	59.9	257	259	324	309	320	8	14.3	6.4	3.2	0.33	1.80	0.99	17.1					
	9.3437 358.775	14.1250 71.438	2.8125 71.438	53.975	2.1250 6.4	3.2	1590	64.4	257	279	346	330	342	8	17.5	6.4	3.2	0.33	1.80	0.99	24.8					

[Note] 1) While metric series bearings have minus tolerances for bore and OD, inch series have plus tolerances. Refer to page 190 for details of applicable tolerance standards.

Single-row tapered roller bearings

d 240 ~ (254.000) mm

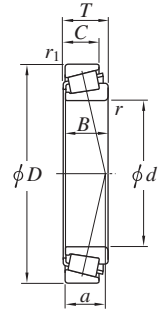

Design 1



Design 1-P

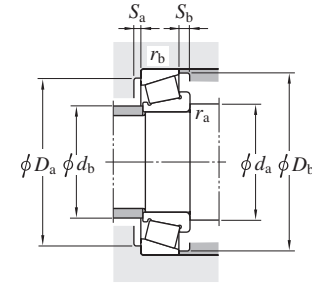

Boundary dimensions										Bearing No. <sup>1)</sup>	De- sign	Basic load ratings (kN)		Load center (mm) a	Mounting dimensions (mm)								Con- stant e	Axial load factors		(Refer.) Mass (kg)			
d	D		T		B		C		r			r <sub>1</sub>	C <sub>r</sub>		C <sub>0r</sub>	d <sub>a</sub>	d <sub>b</sub>	D <sub>a</sub>		D <sub>b</sub>		S <sub>a</sub>		S <sub>b</sub>	r <sub>a</sub>		r <sub>b</sub>	Y <sub>1</sub>	Y <sub>0</sub>
mm	1/25.4	mm	1/25.4	mm	1/25.4	mm	1/25.4	mm	1/25.4	min.	min.			min.	max.	max.	min.	min.	min.	min.	max.	max.							
<b>240</b>	—	320	—	51	—	51	—	39	—	3	2.5	<b>32948JR</b> <b>32048JR</b>	1	515	1 090	64.5	254	254	308	294	311	9	12	2.5	2	0.46	1.31	0.72	10.9
	—	360	—	76	—	76	—	57	—	4	3		1	924	1 720	78.5	258	261	346	318	346	12	19	3	2.5	0.46	1.31	0.72	26.8
<b>241.300</b>	9.5000	327.025	12.8750	52.388	2.0625	52.388	2.0625	36.513	1.4375	6.4	3.2	<b>8578/8520</b> <b>EE923095/923175</b> <b>EE295950/295193</b> <b>EE390095/390200</b>	1	468	930	60.0	261	259	314	299	309	7	15.9	6.4	3.2	0.41	1.48	0.81	11.2
	9.5000	444.500	17.5000	101.600	4.0000	100.013	3.9375	76.200	3.0000	6.4	4.8		1	1 280	1 980	84.4	261	298	428	389	406	7	25.4	6.4	4.8	0.34	1.78	0.98	62.1
	9.5000	488.950	19.2500	120.650	4.7500	120.650	4.7500	92.075	3.6250	6.4	6.4		1	1 680	2 790	92.7	261	328	470	427	446	8	28.6	6.4	6.4	0.31	1.94	1.07	100
	9.5000	508.000	20.0000	117.475	4.6250	95.250	3.7500	73.025	2.8750	6.4	6.4		1	1 230	1 800	168.1	261	303	489	410	455	1	44.5	6.4	6.4	0.94	0.64	0.35	93.7
<b>243.683</b>	9.5938	315.913	12.4375	31.750	1.2500	31.750	1.2500	22.225	0.8750	3.6	3.2	<b>LL648434/LL648415</b>	1	241	549	54.0	257	268	303	295	301	6	9.5	3.6	3.2	0.43	1.39	0.77	6.00
<b>244.475</b>	9.6250	381.000	15.0000	79.375	3.1250	76.200	3.0000	57.150	2.2500	6.4	4.8	<b>EE126097/126150</b>	1	788	1 470	88.5	264	276	365	336	356	5	22.2	6.4	4.8	0.52	1.16	0.64	30.6
<b>247.650</b>	9.7500	304.800	12.0000	22.225	0.8750	22.225	0.8750	15.875	0.6250	1.6	1.6	<b>28880/28820</b> <b>M348449/M348410</b> <b>EE170975/171400</b> <b>EE170975/171450</b> <b>M252337/M252310</b> <b>HH249949/HH249910</b> <b>EE115097/115175</b>	1	155	322	38.8	257	262	295	285	288	6	6.4	1.6	1.6	0.32	1.85	1.02	3.05
	9.7500	346.075	13.6250	63.500	2.5000	63.500	2.5000	50.800	2.0000	6.4	6.4		1	726	1 440	61.7	267	268	327	319	330	9	12.7	6.4	6.4	0.34	1.75	0.96	17.4
	9.7500	355.600	14.0000	50.800	2.0000	50.800	2.0000	33.338	1.3125	6.4	3.2		1	508	924	56.1	267	280	343	327	335	10	17.5	6.4	3.2	0.36	1.65	0.91	15.1
	9.7500	368.300	14.5000	50.800	2.0000	50.800	2.0000	33.338	1.3125	6.4	3.2		1	508	924	56.1	267	280	355	327	335	10	17.5	6.4	3.2	0.36	1.65	0.91	17.0
	9.7500	381.000	15.0000	74.613	2.9375	74.613	2.9375	57.150	2.2500	6.4	3.2		1	854	1 670	69.0	267	295	368	350	363	6	17.5	6.4	3.2	0.33	1.80	0.99	29.7
	9.7500	406.400	16.0000	115.888	4.5625	117.475	4.6250	93.663	3.6875	6.4	6.4		1-P	1 620	3 120	86.3	267	282	387	361	382	11	22.2	6.4	6.4	0.33	1.80	0.99	58.6
<b>249.250</b>	9.8130	381.000	15.0000	79.375	3.1250	76.200	3.0000	57.150	2.2500	6.4	4.8	<b>EE126098/126150</b>	1	788	1 470	88.5	269	276	365	336	356	5	22.2	6.4	4.8	0.52	1.16	0.64	29.5
<b>254.000</b>	10.0000	315.913	12.4375	31.750	1.2500	31.750	1.2500	22.225	0.8750	3.6	4.8	<b>LL648449/LL648416</b> <b>M249749/M249710</b> <b>EE134100/134143</b> <b>EE134100/134145</b> <b>EE275100/275155</b> <b>EE275100/275158</b> <b>HM252343/HM252310</b> <b>HM252344/HM252310</b> <b>HH258232/HH258210</b>	1	241	549	54.0	268	268	300	295	301	6	9.5	3.6	4.8	0.43	1.39	0.77	4.99
	10.0000	358.775	14.1250	71.438	2.8125	71.438	2.8125	53.975	2.1250	3.6	3.2		1	773	1 590	64.4	268	279	346	330	342	8	17.5	3.6	3.2	0.33	1.80	0.99	21.3
	10.0000	365.125	14.3750	58.738	2.3125	58.738	2.3125	42.863	1.6875	6.4	6.4		1	566	1 070	63.7	273	286	346	334	345	8	15.9	6.4	6.4	0.37	1.60	0.88	18.2
	10.0000	368.300	14.5000	58.738	2.3125	58.738	2.3125	42.863	1.6875	6.4	6.4		1	566	1 070	63.7	273	286	349	334	345	8	15.9	6.4	6.4	0.37	1.60	0.88	18.8
	10.0000	393.700	15.5000	73.817	2.9062	69.850	2.7500	50.005	1.9687	6.4	6.4		1	738	1 540	75.4	273	314	374	364	377	5	23.8	6.4	6.4	0.40	1.49	0.82	31.1
	10.0000	403.225	15.8750	69.850	2.7500	69.850	2.7500	46.038	1.8125	6.4	6.4		1	738	1 540	71.5	273	314	384	365	377	9	23.8	6.4	6.4	0.40	1.49	0.82	32.5
	10.0000	422.275	16.6250	86.121	3.3906	79.771	3.1406	66.675	2.6250	6.7	3.2		1	1 010	1 680	78.7	274	309	409	384	399	1	19.4	6.7	3.2	0.33	1.80	0.99	42.7
	10.0000	422.275	16.6250	86.121	3.3906	79.771	3.1406	66.675	2.6250	6.7	3.2		1	1 010	1 680	78.7	274	309	409	384	399	1	19.4	6.7	3.2	0.33	1.80	0.99	42.7
	10.0000	495.300	19.5000	141.288	5.5625	141.288	5.5625	114.300	4.5000	6.4	6.4		1-P	2 330	4 670	108.1	273	346	476	441	467	8	27	6.4	6.4	0.33	1.80	0.99	128

[Note] 1) While metric series bearings have minus tolerances for bore and OD, inch series have plus tolerances. Refer to page 190 for details of applicable tolerance standards.

# Single-row tapered roller bearings

d (254.000) ~ (279.400) mm

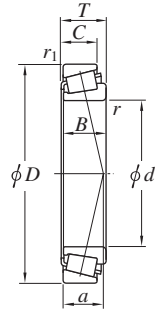

Design 1



Design 1-P

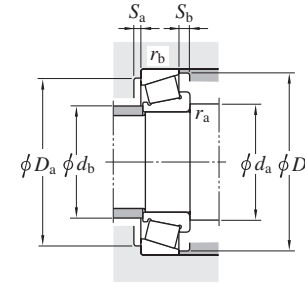

Boundary dimensions								Bearing No. 1)	De- sign	Basic load ratings (kN)		Load center (mm) a	Mounting dimensions (mm)								Con- stant e	Axial load factors		(Refer.) Mass (kg)		
d	D		T		B		C			r	r1		Cr	Cor	da	db	Da	Db	Sa	Sb		ra	rb		Y1	Y0
mm	1/25.4	mm	1/25.4	mm	1/25.4	mm	1/25.4			mm	1/25.4		min.	min.	min.	max.	max.	min.	min.	min.		min.	max.		max.	
254.000	10.0000	533.400	21.0000	133.350	5.2500	120.650	4.7500	77.788	3.0625	6.4	6.4	180.8	273	324	510	446	495	4	55.6	6.4	6.4	0.94	0.64	0.35	127	
255.600	10.0630	342.900	13.5000	57.150	2.2500	63.500	2.5000	44.450	1.7500	1.6	3.2	60.1	265	276	330	320	330	6	12.7	1.6	3.2	0.35	1.73	0.95	14.1	
257.175	10.1250	342.900	13.5000	57.150	2.2500	57.150	2.2500	44.450	1.7500	6.4	3.2	60.1	276	276	330	320	330	6	12.7	6.4	3.2	0.35	1.73	0.95	13.3	
	10.1250	358.775	14.1250	71.438	2.8125	76.200	3.0000	53.975	2.1250	1.6	3.2	64.4	267	279	346	330	342	8	17.5	1.6	3.2	0.33	1.80	0.99	21	
258.763	10.1875	400.050	15.7500	69.850	2.7500	67.470	2.6563	46.038	1.8125	9.5	6.4	71.2	284	295	381	359	371	6	23.8	9.5	6.4	0.39	1.52	0.84	26.7	
260	—	360	—	63.5	—	63.5	—	48	—	3	2.5	69.6	274	279	348	328	347	11	15.5	2.5	2	0.41	1.48	0.81	18.9	
	—	400	—	87	—	87	—	65	—	5	4	85.0	282	287	382	352	383	14	22	4	3	0.43	1.38	0.76	39.5	
260.350	10.2500	365.125	14.3750	58.738	2.3125	58.738	2.3125	42.863	1.6875	6.4	6.4	63.7	280	286	346	334	345	8	15.9	6.4	6.4	0.37	1.60	0.88	17.1	
	10.2500	419.100	16.5000	85.725	3.3750	84.138	3.3125	61.913	2.4375	6.4	3.2	106.0	280	296	406	369	394	6	23.8	6.4	3.2	0.60	0.99	0.55	42.3	
	10.2500	422.275	16.6250	86.121	3.3906	79.771	3.1406	66.675	2.6250	6.7	3.2	78.7	280	309	409	384	399	1	19.4	6.7	3.2	0.33	1.80	0.99	41.2	
	10.2500	422.275	16.6250	86.121	3.3906	79.771	3.1406	66.675	2.6250	6.7	3.2	78.7	280	309	409	384	399	1	19.4	6.7	3.2	0.33	1.80	0.99	41.2	
	10.2500	431.724	16.9970	82.550	3.2500	79.771	3.1406	60.325	2.3750	6.7	3.6	75.2	280	309	418	384	397	4	22.2	6.7	3.6	0.33	1.80	0.99	42.9	
	10.2500	431.724	16.9970	82.550	3.2500	79.771	3.1406	60.325	2.3750	6.7	3.6	75.2	280	309	418	384	397	4	22.2	6.7	3.6	0.33	1.80	0.99	42.9	
263.525	10.3750	325.438	12.8125	28.575	1.1250	28.575	1.1250	25.400	1.0000	1.6	1.6	48.6	273	281	316	306	312	6	3.2	1.6	1.6	0.37	1.64	0.90	5.08	
264.975	10.4321	355.600	14.0000	57.150	2.2500	62.000	2.4409	44.450	1.7500	3.6	3.2	62.3	279	287	343	332	342	8	12.7	3.6	3.2	0.36	1.67	0.92	15.3	
266.700	10.5000	325.438	12.8125	28.575	1.1250	28.575	1.1250	25.400	1.0000	1.6	1.6	48.6	276	281	316	306	312	6	3.2	1.6	1.6	0.37	1.64	0.90	4.79	
	10.5000	355.600	14.0000	57.150	2.2500	57.150	2.2500	44.450	1.7500	3.6	3.2	62.3	280	287	343	332	342	8	12.7	3.6	3.2	0.36	1.67	0.92	14.7	
	10.5000	393.700	15.5000	73.817	2.9062	69.850	2.7500	50.005	1.9687	6.4	6.4	75.4	286	314	374	364	377	5	23.8	6.4	6.4	0.40	1.49	0.82	28.3	
	10.5000	444.500	17.5000	120.650	4.7500	117.475	4.6250	88.900	3.5000	6.4	6.4	121.3	286	300	425	390	424	9	31.8	6.4	6.4	0.58	1.04	0.57	71.2	
269.875	10.6250	381.000	15.0000	74.613	2.9375	74.613	2.9375	57.150	2.2500	6.4	3.2	69.0	289	295	368	350	363	6	17.5	6.4	3.2	0.33	1.80	0.99	24.5	
276.225	10.8750	352.425	13.8750	36.513	1.4375	34.925	1.3750	23.813	0.9375	3.6	3.2	71.2	290	295	340	329	337	7	12.7	3.6	3.2	0.54	1.11	0.61	7.53	
279.400	11.0000	469.900	18.5000	95.250	3.7500	93.663	3.6875	69.850	2.7500	9.5	3.2	87.2	305	332	457	412	430	7	25.4	9.5	3.2	0.38	1.59	0.88	60.7	

[Note] 1) While metric series bearings have minus tolerances for bore and OD, inch series have plus tolerances. Refer to page 190 for details of applicable tolerance standards.

# Single-row tapered roller bearings

d (279.400) ~ 330.200 mm

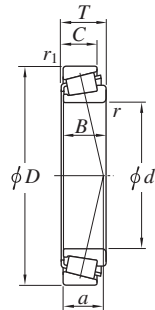

Design 1



Design 1-P

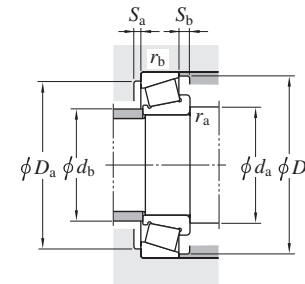

Boundary dimensions										Bearing No. <sup>1)</sup>	De- sign	Basic load ratings (kN)		Load center (mm) a	Mounting dimensions (mm)								Con- stant e	Axial load factors		(Refer.) Mass (kg)
d	D	T	B	C	r	r <sub>1</sub>	C <sub>r</sub>	C <sub>0r</sub>	d <sub>a</sub>			d <sub>b</sub>	D <sub>a</sub>		D <sub>b</sub>	S <sub>a</sub>	S <sub>b</sub>	r <sub>a</sub>	r <sub>b</sub>	Y <sub>1</sub>	Y <sub>0</sub>					
mm	mm	mm	mm	mm	mm	mm	mm	mm	mm	mm	mm	mm	mm	mm	mm	mm	mm									
279.400	488.950	120.650	120.650	92.075	1.2	6.4	1680	2790	288	328	470	427	446	8	28.6	1.2	6.4	0.31	1.94	1.07	85.5					
280	380	63.5	63.5	48	3	2.5	760	1630	294	298	368	347	368	11	15.5	2.5	2	0.43	1.39	0.76	20.1					
	420	87	87	65	5	4	1200	2280	302	305	402	370	402	14	22	4	3	0.46	1.31	0.72	41.7					
285.750	358.775	33.338	31.750	22.225	3.6	3.2	240	537	299	308	346	337	344	6	11.1	3.6	3.2	0.49	1.23	0.68	6.75					
	380.898	65.088	65.088	49.213	3.6	3.2	664	1410	299	307	368	356	370	7	15.9	3.6	3.2	0.43	1.39	0.77	18.9					
288.925	406.400	77.788	77.788	60.325	6.4	3.2	1010	2210	308	318	394	373	387	8	17.5	6.4	3.2	0.34	1.77	0.98	30.9					
292.100	374.650	47.625	47.625	34.925	3.6	3.2	468	971	306	309	362	351	360	8	12.7	3.6	3.2	0.40	1.49	0.82	11.5					
298.450	444.500	63.500	61.913	39.688	7.9	1.6	721	1380	321	346	435	403	413	11	23.8	7.9	1.6	0.38	1.59	0.87	30.4					
300	420	76	76	57	4	3	1050	2210	318	324	406	383	405	12	19	3	2.5	0.39	1.52	0.84	32.4					
	460	100	100	74	5	4	1430	2660	322	329	442	404	439	15	26	4	3	0.43	1.38	0.76	57.5					
300.038	422.275	82.550	82.550	63.500	6.4	3.2	990	2010	320	328	408	388	402	7	19.1	6.4	3.2	0.34	1.78	0.98	33.6					
304.800	393.700	50.800	50.800	38.100	6.4	3.2	524	1180	325	329	380	369	378	5	12.7	6.4	3.2	0.36	1.67	0.92	14.6					
	406.400	63.500	63.500	47.625	6.4	3.2	748	1580	325	324	393	376	390	8	15.9	6.4	3.2	0.44	1.36	0.75	21.2					
	444.500	63.500	61.913	39.688	7.9	1.6	721	1380	328	346	434	403	413	11	23.8	7.9	1.6	0.38	1.59	0.87	29.0					
	495.300	95.250	92.075	69.850	16	6.4	1270	2340	344	359	475	438	457	6	25.4	16	6.4	0.40	1.49	0.82	64.8					
317.500	444.500	63.500	61.913	39.688	7.9	1.6	721	1380	341	346	434	403	413	11	23.8	7.9	1.6	0.38	1.59	0.87	26.0					
	447.675	85.725	85.725	68.263	3.6	3.2	1120	2390	332	346	434	410	427	8	17.5	3.6	3.2	0.33	1.79	0.99	40.2					
	622.300	147.638	131.763	82.550	14.3	12.7	2220	3490	354	390	585	530	580	7	65.1	14.3	12.7	0.94	0.64	0.35	179					
320	440	76	76	57	4	3	1060	2270	338	342	426	401	426	12	19	3	2.5	0.42	1.44	0.79	34.0					
	480	100	100	74	5	4	1510	2810	342	344	462	418	461	16	26	4	3	0.46	1.31	0.72	58.7					
323.850	381.000	28.575	28.575	20.638	3.6	3.3	219	570	339	340	367	363	369	5	7.9	3.6	3.3	0.44	1.36	0.75	5.15					
330.200	415.925	47.625	47.625	34.925	3.6	3.2	453	1080	345	351	402	389	401	6	12.7	3.6	3.2	0.50	1.20	0.66	13.8					

[Note] 1) While metric series bearings have minus tolerances for bore and OD, inch series have plus tolerances. Refer to page 190 for details of applicable tolerance standards.



# Single-row tapered roller bearings

$d$  333.375 ~ 371.475 mm

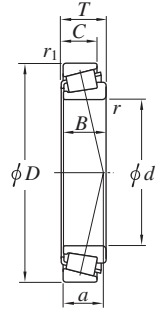

Design 1



Design 1-P

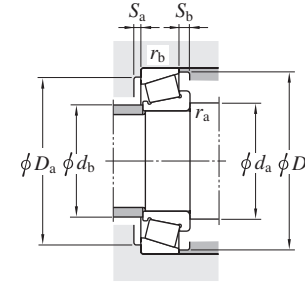

Boundary dimensions								Bearing No. 1)	De- sign	Basic load ratings (kN)		Load center (mm) a	Mounting dimensions (mm)								Constant e	Axial load factors		(Refer.) Mass (kg)
d	D	T	B	C	r	r <sub>1</sub>	C <sub>r</sub>			C <sub>0r</sub>	d <sub>a</sub>		d <sub>b</sub>	D <sub>a</sub>	D <sub>b</sub>	S <sub>a</sub>	S <sub>b</sub>	r <sub>a</sub>	r <sub>b</sub>	Y <sub>1</sub>		Y <sub>0</sub>		
mm	mm	mm	mm	mm	mm	min.	mm			mm	min.		min.	max.	min.	min.	min.	min.	max.	max.				
333.375	469.900	90.488	90.488	71.438	6.4	3.2	1 220	2 580	84.3	354	365	456	430	446	8	19.1	6.4	3.2	0.33	1.79	0.99	46.2		
340	460	76	76	57	4	3	1 070	2 340	90.5	358	361	446	420	446	12	19	3	2.5	0.44	1.37	0.75	35.6		
342.900	450.850	66.675	66.675	52.388	8.5	3.6	845	1 980	76.2	367	370	436	420	433	9	14.3	8.5	3.6	0.35	1.70	0.94	27.8		
	457.098	66.675	63.500	46.038	3.2	3.2	729	1 670	122.3	357	366	443	420	442	8	20.6	3.2	3.2	0.71	0.84	0.46	28.2		
	533.400	76.200	76.200	50.800	4.8	3.2	1 090	1 790	79.4	360	397	520	482	493	8	25.4	4.8	3.2	0.33	1.80	0.99	53.8		
346.075	482.600	60.325	55.563	38.100	7.1	6.4	613	1 250	93.7	368	388	462	440	453	7	22.2	7.1	6.4	0.50	1.20	0.66	29.4		
	482.600	66.675	63.500	44.450	6.7	6.7	725	1 430	86.6	367	386	462	442	454	6	22.2	6.7	6.7	0.42	1.44	0.79	32.4		
	488.950	95.250	95.250	74.613	6.4	3.2	1 350	2 900	88.5	366	382	475	450	466	8	20.6	6.4	3.2	0.33	1.79	0.99	53.3		
349.250	501.650	90.488	84.138	69.850	6.4	3.2	1 280	2 550	95.2	370	391	488	465	482	7	20.6	6.4	3.2	0.37	1.60	0.88	53.0		
354.013	469.900	60.325	55.563	38.100	7.1	6.4	613	1 250	93.7	376	388	450	440	453	7	22.2	7.1	6.4	0.50	1.20	0.66	24.7		
	488.950	60.325	55.563	38.100	7.1	6.4	613	1 250	93.7	376	388	469	440	453	7	22.2	7.1	6.4	0.50	1.20	0.66	28.9		
355.600	444.500	60.325	60.325	47.625	3.6	3.2	647	1 720	67.0	370	379	431	417	427	8	12.7	3.6	3.2	0.31	1.95	1.07	20.3		
	469.900	60.325	55.563	38.100	7.1	6.4	613	1 250	93.7	377	388	450	440	453	7	22.2	7.1	6.4	0.50	1.20	0.66	24.3		
	482.600	60.325	55.563	38.100	7.1	6.4	613	1 250	93.7	377	388	462	440	453	7	22.2	7.1	6.4	0.50	1.20	0.66	27.1		
	488.950	60.325	55.563	38.100	7.1	6.4	613	1 250	93.7	377	388	469	440	453	7	22.2	7.1	6.4	0.50	1.20	0.66	28.5		
	501.650	74.613	66.675	50.800	6.4	3.2	790	1 640	97.3	376	409	488	465	480	2	23.8	6.4	3.2	0.44	1.36	0.75	40.5		
	501.650	90.488	84.138	69.850	6.4	3.2	1 280	2 550	95.2	376	391	488	465	482	7	20.6	6.4	3.2	0.37	1.60	0.88	50.7		
360	480	76	76	57	4	3	1 080	2 400	96.2	378	379	466	438	466	12	19	3	2.5	0.46	1.31	0.72	37.1		
368.249	523.875	101.600	101.600	79.375	6.4	6.4	1 590	3 390	94.0	388	408	500	483	500	7	22.2	6.4	6.4	0.33	1.80	0.99	56.6		
368.300	596.900	95.250	92.075	60.325	9.5	6.4	1 410	2 330	104.3	395	431	575	535	545	11	34.9	9.5	6.4	0.42	1.44	0.79	83.0		
	609.600	142.875	139.700	111.125	7.9	6.4	2 510	4 530	121.4	392	427	585	545	570	7	31.8	7.9	6.4	0.36	1.69	0.93	152		
371.475	501.650	74.613	66.675	50.800	6.4	3.2	790	1 640	97.3	392	409	488	465	480	2	23.8	6.4	3.2	0.44	1.36	0.75	35.8		
	514.350	74.613	66.675	50.800	6.4	3.2	790	1 640	97.3	392	409	500	465	480	2	23.8	6.4	3.2	0.44	1.36	0.75	39.8		

[Note] 1) While metric series bearings have minus tolerances for bore and OD, inch series have plus tolerances. Refer to page 190 for details of applicable tolerance standards.

**Single-row tapered roller bearings**

*d* 381.000 ~ 415.925 mm

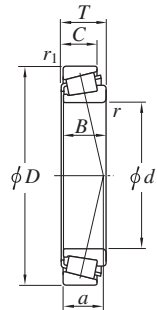

Design 1

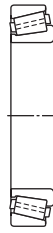

Design 1-P

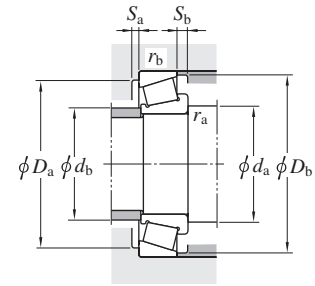

Boundary dimensions							Bearing No. <sup>1)</sup>	De- sign	Basic load ratings (kN)		Load center (mm) <i>a</i>	Mounting dimensions (mm)								Con- stant <i>e</i>	Axial load factors		(Refer.) Mass (kg)						
<i>d</i>	<i>D</i>		<i>T</i>		<i>B</i>				<i>C</i>			<i>r</i>	<i>r</i> <sub>1</sub>	<i>d</i> <sub>a</sub>	<i>d</i> <sub>b</sub>	<i>D</i> <sub>a</sub>		<i>D</i> <sub>b</sub>			<i>S</i> <sub>a</sub>	<i>S</i> <sub>b</sub>		<i>r</i> <sub>a</sub>	<i>r</i> <sub>b</sub>	<i>Y</i> <sub>1</sub>	<i>Y</i> <sub>0</sub>		
mm	1/25.4	mm	1/25.4	mm	1/25.4	mm			1/25.4	mm		1/25.4	min.	min.	min.	max.	max.	min.	min.		min.	min.		max.	max.				
<b>381.000</b>	15.0000	479.425	18.8750	49.213	1.9375	47.625	1.8750	34.925	1.3750	6.4	3.2	L865547/L865512	1	595	1 280	91.4	401	405	466	454	465	8	14.3	6.4	3.2	0.49	1.23	0.68	18.9
	15.0000	508.000	20.0000	63.500	2.5000	58.738	2.3125	38.100	1.5000	6.4	3.2	EE192150/192200	1	689	1 490	101.9	401	412	494	466	479	9	25.4	6.4	3.2	0.53	1.13	0.62	30.0
	15.0000	522.288	20.5625	85.725	3.3750	84.138	3.3125	61.913	2.4375	6.4	3.2	LM565949/LM565910	1	1 170	2 590	92.8	401	414	505	480	496	10	23.8	6.4	3.2	0.38	1.56	0.86	50.0
	15.0000	523.875	20.6250	85.725	3.3750	84.138	3.3125	61.913	2.4375	6.4	3.2	LM565949/LM565912	1	1 170	2 590	92.8	401	414	510	480	496	10	23.8	6.4	3.2	0.38	1.56	0.86	50.7
	15.0000	546.100	21.5000	104.775	4.1250	104.775	4.1250	82.550	3.2500	6.4	6.4	HM266446/HM266410	1-P	1 900	4 210	97.6	401	421	525	505	515	10	22.2	6.4	6.4	0.33	1.80	0.99	79.5
	15.0000	546.100	21.5000	104.775	4.1250	104.775	4.1250	82.550	3.2500	6.4	6.4	HM266447/HM266410	1-P	1 900	4 210	97.6	401	421	525	505	515	10	22.2	6.4	6.4	0.33	1.80	0.99	79.5
<b>384.175</b>	15.1250	546.100	21.5000	104.775	4.1250	104.775	4.1250	82.550	3.2500	6.4	6.4	HM266448/HM266410	1-P	1 900	4 210	97.6	404	421	525	505	515	10	22.2	6.4	6.4	0.33	1.80	0.99	78.0
	15.1250	546.100	21.5000	104.775	4.1250	104.775	4.1250	82.550	3.2500	6.4	6.4	HM266449/HM266410	1-P	1 900	4 210	97.6	404	421	525	505	515	10	22.2	6.4	6.4	0.33	1.80	0.99	78.0
<b>385.763</b>	15.1875	514.350	20.2500	82.550	3.2500	82.550	3.2500	63.500	2.5000	6.4	3.2	LM665949/LM665910	1	1 210	2 710	98.2	406	411	500	477	494	9	19.1	6.4	3.2	0.42	1.43	0.79	44.6
<b>393.700</b>	15.5000	546.100	21.5000	76.200	3.0000	61.120	2.4063	55.562	2.1875	6.4	6.4	EE234154/234215	1	867	1 910	113.3	414	441	525	497	510	1	20.6	6.4	6.4	0.48	1.26	0.69	46.4
	15.6250	546.100	21.5000	76.200	3.0000	61.120	2.4063	55.562	2.1875	6.4	6.4	EE234156/234215	1	867	1 910	113.3	417	441	525	497	510	1	20.6	6.4	6.4	0.48	1.26	0.69	45.5
	15.6250	558.800	22.0000	65.088	2.5625	61.120	2.4063	44.450	1.7500	6.4	6.4	EE234156/234220	1	867	1 910	102.2	417	441	535	505	510	10	20.6	6.4	6.4	0.48	1.26	0.69	44.9
<b>406.400</b>	16.0000	508.000	20.0000	61.913	2.4375	61.913	2.4375	47.625	1.8750	3.2	3.2	L467549/L467510	1	851	2 130	82.1	421	428	493	477	489	9	14.3	3.2	3.2	0.37	1.64	0.90	27.2
	16.0000	546.100	21.5000	76.200	3.0000	61.120	2.4063	55.562	2.1875	6.4	6.4	EE234160/234215	1	867	1 910	113.3	428	441	520	497	510	1	20.6	6.4	6.4	0.48	1.26	0.69	—
	16.0000	546.100	21.5000	87.313	3.4375	87.313	3.4375	68.263	2.6875	6.4	6.4	M667944/M667911	1	1 330	2 870	105.1	428	438	520	510	525	8	19.1	6.4	6.4	0.42	1.44	0.79	53.7
	16.0000	558.800	22.0000	65.088	2.5625	61.120	2.4063	44.450	1.7500	6.4	6.4	EE234160/234220	1	867	1 910	102.2	428	441	535	505	510	10	20.6	6.4	6.4	0.48	1.26	0.69	42.0
	16.0000	574.675	22.6250	76.200	3.0000	67.866	2.6719	50.800	2.0000	6.7	3.2	EE285160/285226	1	949	1 940	114.9	428	450	560	520	530	5	25.4	6.7	3.2	0.50	1.20	0.66	53.3
	16.0000	590.550	23.2500	107.950	4.2500	107.950	4.2500	80.963	3.1875	9.5	6.4	EE833160X/833232	1	1 780	3 540	100.0	434	453	565	545	560	9	27	9.5	6.4	0.32	1.85	1.02	89.7
	16.0000	609.524	23.9970	82.550	3.2500	79.375	3.1250	60.325	2.3750	7.9	6.4	EE736160/736238	1	1 520	3 030	95.9	431	477	585	565	570	8	22.2	7.9	6.4	0.35	1.73	0.95	76.2
	16.0000	609.600	24.0000	92.075	3.6250	84.138	3.3125	60.325	2.3750	6.7	6.4	EE911600/912400	1	1 430	2 640	105.6	428	466	585	555	570	5	31.8	6.7	6.4	0.38	1.57	0.86	80.1
	16.0000	673.100	26.5000	88.900	3.5000	87.833	3.4580	60.325	2.3750	6.4	3.2	EE571602/572650	1	1 470	2 620	111.7	428	505	655	610	620	8	28.6	6.4	3.2	0.40	1.49	0.82	109
<b>409.575</b>	16.1250	546.100	21.5000	87.313	3.4375	87.313	3.4375	68.263	2.6875	6.4	6.4	M667947/M667911	1	1 330	2 870	105.1	431	438	520	510	525	8	19.1	6.4	6.4	0.42	1.44	0.79	52.4
	16.1250	546.100	21.5000	87.313	3.4375	87.313	3.4375	66.675	2.6250	6.4	6.4	M667948/M667910	1	1 330	2 870	105.1	431	438	520	510	525	8	20.6	6.4	6.4	0.42	1.44	0.79	52.2
<b>411.163</b>	16.1875	609.600	24.0000	92.075	3.6250	84.138	3.3125	60.325	2.3750	6.7	6.4	EE911618/912400	1	1 430	2 640	105.6	433	466	585	555	570	5	31.8	6.7	6.4	0.38	1.57	0.86	78.1
<b>415.925</b>	16.3750	590.550	23.2500	114.300	4.5000	114.300	4.5000	88.900	3.5000	6.4	6.4	M268749/M268710	1-P	1 980	4 470	103.7	437	460	565	545	560	9	25.4	6.4	6.4	0.33	1.80	0.99	96.1

[Note] 1) While metric series bearings have minus tolerances for bore and OD, inch series have plus tolerances. Refer to page 190 for details of applicable tolerance standards.

Single-row tapered roller bearings

d 430.213 ~ (488.950) mm

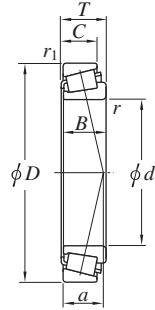

Design 1



Design 1-P

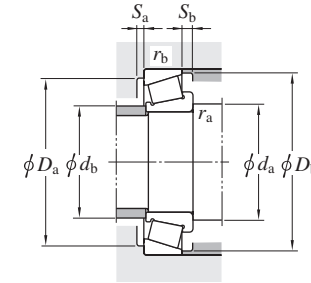

Boundary dimensions								Bearing No. <sup>1)</sup>	Design	Basic load ratings (kN)		Load center (mm) a	Mounting dimensions (mm)								Constant e	Axial load factors		(Refer.) Mass (kg)					
d mm	D mm		T mm		B mm		r min.			r1 min.	Cr		Cor	da min.	db max.	Da max.	Db min.	Sa min.	Sb min.	ra max.		rb max.	Y1		Y0				
	1/25.4	1/25.4	1/25.4	1/25.4	1/25.4	1/25.4																				1/25.4			
430.213	16.9375	603.250	23.7500	76.200	3.0000	73.025	2.8750	50.800	2.0000	6.4	6.4	EE241693/242375	1	977	1 880	122.8	451	473	580	545	560	2	25.4	6.4	6.4	0.53	1.14	0.63	54.0
431.800	17.0000	571.500	22.5000	73.025	2.8750	73.025	2.8750	53.975	2.1250	3.2	3.2	EE239170/239225	1	980	2 150	96.5	447	470	555	535	540	5	19.1	3.2	3.2	0.38	1.57	0.86	45.6
	17.0000			74.613	2.9375	74.613	2.9375	52.388	2.0625	3.2	3.2	LM869448/LM869410	1	979	2 140	124.4	447	468	555	535	550	7	22.2	3.2	3.2	0.55	1.10	0.60	47.1
	17.0000	571.500	22.5000	76.200	3.0000	73.025	2.8750	57.150	2.2500	3.2	3.2	EE239170/239225A	1	980	2 150	99.7	447	470	555	535	540	2	19.1	3.2	3.2	0.38	1.57	0.86	46.8
	17.0000			76.200	3.0000	73.025	2.8750	50.800	2.0000	6.4	6.4	EE241701/242375	1	977	1 880	122.8	453	473	580	545	560	2	25.4	6.4	6.4	0.53	1.14	0.63	53.4
17.0000	673.100	26.5000	88.900	3.5000	87.833	3.4580	60.325	2.3750	6.4	3.2	EE571703/572650	1	1 470	2 620	111.7	453	505	655	610	620	8	28.6	6.4	3.2	0.40	1.49	0.82	97.4	
441.325	17.3750	660.400	26.0000	91.280	3.5937	85.725	3.3750	62.705	2.4687	10.4	6.4	EE737173/737260	1	1 350	2 630	109.5	471	510	635	600	610	7	28.6	10.4	6.4	0.37	1.60	0.88	95.5
447.675	17.6250	552.450	21.7500	44.450	1.7500	44.450	1.7500	31.750	1.2500	3.2	3.2	80176/80217	1	636	1 520	72.4	463	481	535	525	530	10	12.7	3.2	3.2	0.32	1.88	1.04	21.0
	17.6250	565.150	22.2500	44.450	1.7500	44.450	1.7500	31.750	1.2500	3.2	3.2	80176/80222	1	636	1 520	72.4	463	481	550	525	530	10	12.7	3.2	3.2	0.32	1.88	1.04	23.8
	17.6250	635.000	25.0000	120.650	4.7500	120.650	4.7500	95.250	3.7500	6.4	6.4	M270749/M270710	1-P	2 290	5 250	113.8	469	495	610	585	600	8	25.4	6.4	6.4	0.33	1.80	0.99	118
450.850	17.7500	603.250	23.7500	85.725	3.3750	84.138	3.3125	60.325	2.3750	6.4	3.2	LM770945/LM770910	1	1 380	3 170	116.0	472	493	585	565	580	10	25.4	6.4	3.2	0.45	1.32	0.73	63.4
456.692	17.9800	660.400	26.0000	92.075	3.6250	91.262	3.5930	63.500	2.5000	6.4	6.4	EE737179X/737262	1	1 350	2 630	110.3	478	510	635	600	610	6	28.6	6.4	6.4	0.37	1.60	0.88	90.5
456.794	17.9840	761.873	29.9950	142.875	5.6250	142.875	5.6250	101.600	4.0000	16	6.4	EE425179A/425299	1-P	3 240	5 610	154.5	497	530	740	685	710	8	41.3	16	6.4	0.44	1.35	0.74	242
457.200	18.0000	573.088	22.5625	74.613	2.9375	74.613	2.9375	57.150	2.2500	6.4	6.4	L570649/L570610	1	1 100	2 930	100.4	478	484	550	540	550	10	17.5	6.4	6.4	0.40	1.49	0.82	42.7
	18.0000	596.900	23.5000	76.200	3.0000	73.025	2.8750	53.975	2.1250	9.5	3.2	EE244180/244235	1	1 120	2 620	103.1	485	492	580	555	570	7	22.2	9.5	3.2	0.40	1.48	0.82	50.1
	18.0000	615.950	24.2500	85.725	3.3750	85.725	3.3750	66.675	2.6250	6.4	6.4	LM272235/LM272210	1	1 410	3 560	98.4	478	515	590	585	590	8	19.1	6.4	6.4	0.33	1.80	0.99	71.8
476.250	18.7500	565.150	22.2500	41.275	1.6250	41.275	1.6250	31.750	1.2500	3.2	3.2	LL771948/LL771911	1	520	1 530	99.3	491	499	550	535	540	8	9.5	3.2	3.2	0.47	1.28	0.70	18.4
479.425	18.8750	679.450	26.7500	128.588	5.0625	128.588	5.0625	101.600	4.0000	6.4	6.4	M272749/M272710	1-P	2 470	5 550	122.2	500	530	655	630	645	7	27	6.4	6.4	0.33	1.80	0.99	140
482.600	19.0000	615.950	24.2500	85.725	3.3750	85.725	3.3750	66.675	2.6250	6.4	6.4	LM272249/LM272210	1	1 410	3 560	98.4	505	515	590	585	590	8	19.1	6.4	6.4	0.33	1.80	0.99	59.3
	19.0000	634.873	24.9950	80.963	3.1875	80.963	3.1875	63.500	2.5000	6.4	3.2	EE243190/243250	1	1 320	3 290	100.0	505	530	620	595	605	9	17.5	6.4	3.2	0.34	1.75	0.96	66.3
488.671	19.2390	660.400	26.0000	93.663	3.6875	94.458	3.7188	69.850	2.7500	6.4	6.4	EE640191/640260	1-P	1 810	3 960	98.4	510	530	635	615	630	11	23.8	6.4	6.4	0.31	1.95	1.07	86.9
488.950	19.2500	634.873	24.9950	84.138	3.3125	84.138	3.3125	61.913	2.4375	6.4	3.2	LM772748/LM772710	1	1 440	3 420	124.5	510	515	620	595	610	9	22.2	6.4	3.2	0.47	1.27	0.70	63.7

[Note] 1) While metric series bearings have minus tolerances for bore and OD, inch series have plus tolerances. Refer to page 190 for details of applicable tolerance standards.

*d* (488.950) ~ 759.924 mm

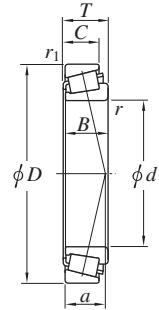

Design 1



Design 1-P

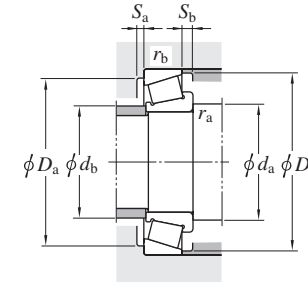

Boundary dimensions										Bearing No. <sup>1)</sup>	De- sign	Basic load ratings (kN)		Load center (mm) <i>a</i>	Mounting dimensions (mm)								Con- stant <i>e</i>	Axial load factors		(Refer.) Mass (kg)
<i>d</i> mm	<i>D</i> mm	<i>T</i> mm	<i>B</i> mm	<i>C</i> mm	<i>r</i> min.	<i>r</i> <sub>1</sub> min.	<i>C</i> <sub>r</sub>	<i>C</i> <sub>0r</sub>	<i>d</i> <sub>a</sub> min.			<i>d</i> <sub>b</sub> max.	<i>D</i> <sub>a</sub> max.		<i>D</i> <sub>b</sub> min.	<i>S</i> <sub>a</sub> min.	<i>S</i> <sub>b</sub> min.	<i>r</i> <sub>a</sub> max.	<i>r</i> <sub>b</sub> max.	<i>Y</i> <sub>1</sub>	<i>Y</i> <sub>0</sub>					
488.950	660.400	93.663	94.458	69.850	6.4	6.4	1 810	3 960	98.4	510	530	635	615	630	11	23.8	6.4	6.4	0.31	1.95	1.07	86.8				
489.026	634.873	80.963	80.963	63.500	6.4	3.2	1 320	3 290	100.0	510	530	620	595	605	9	17.5	6.4	3.2	0.34	1.75	0.96	63.2				
498.475	634.873	80.963	80.963	63.500	6.4	3.2	1 320	3 290	100.0	520	530	620	595	605	9	17.5	6.4	3.2	0.34	1.75	0.96	58.6				
501.650	711.200	136.525	136.525	106.363	6.4	6.4	2 800	6 410	126.8	525	550	685	655	675	10	30.2	6.4	6.4	0.33	1.80	0.99	164				
520.700	736.600	88.900	81.758	53.975	6.4	3.2	1 470	2 580	136.4	545	570	720	675	690	5	34.9	6.4	3.2	0.48	1.26	0.69	97.5				
536.575	761.873	146.050	146.050	114.300	6.4	6.4	3 290	7 190	135.7	560	580	740	700	720	9	31.8	6.4	6.4	0.33	1.80	0.99	202				
539.750	635.000	50.800	50.800	38.100	6.4	6.4	752	1 970	101.4	565	560	610	610	620	9	12.7	6.4	6.4	0.41	1.48	0.81	25.7				
549.097	692.150	80.963	80.962	61.913	6.4	6.4	1 410	3 700	113.6	570	580	670	650	660	9	19.1	6.4	6.4	0.38	1.59	0.88	67.7				
549.275	692.150	80.963	80.963	61.913	6.4	6.4	1 410	3 700	113.6	575	580	670	650	660	9	19.1	6.4	6.4	0.38	1.59	0.88	67.5				
558.800	736.600	88.108	88.108	63.500	6.4	6.4	1 730	4 020	110.7	580	610	710	695	705	9	24.6	6.4	6.4	0.34	1.75	0.96	94.2				
584.200	685.800	49.213	49.213	34.925	3.6	3.2	723	1 930	113.8	600	610	670	660	665	10	14.3	3.6	3.2	0.44	1.36	0.75	29.4				
607.720	787.400	93.663	93.663	69.850	6.4	6.4	1 980	4 970	126.9	630	650	760	740	750	12	23.8	6.4	6.4	0.37	1.61	0.89	113				
609.600	762.000	95.250	92.075	71.438	6.4	6.4	1 700	4 510	153.0	635	640	735	720	740	9	23.8	6.4	6.4	0.49	1.23	0.67	91.2				
	787.400	93.663	93.663	69.850	6.4	6.4	1 980	4 970	126.9	635	650	760	740	750	12	23.8	6.4	6.4	0.37	1.61	0.89	112				
	812.800	82.550	82.550	60.325	6.4	6.4	1 910	4 290	112.7	635	660	790	755	765	12	22.2	6.4	6.4	0.33	1.83	1.01	112				
660.400	854.075	85.725	85.468	60.325	9.5	6.4	1 820	4 000	125.1	690	705	830	800	810	8	25.4	9.5	6.4	0.35	1.71	0.94	111				
685.800	876.300	93.663	92.075	69.850	6.4	6.4	2 050	5 390	149.1	710	735	850	830	840	9	23.8	6.4	6.4	0.42	1.44	0.79	132				
749.300	990.600	159.500	160.338	123.000	6.4	6.4	4 580	11 900	261.4	775	800	960	930	950	12	36.5	6.4	6.4	0.32	1.88	1.04	327				
759.924	889.000	88.900	88.900	71.999	3.2	3.2	1 860	5 630	123.1	780	785	870	860	870	11	16.9	3.2	3.2	0.31	1.97	1.08	90.5				

[Note] 1) While metric series bearings have minus tolerances for bore and OD, inch series have plus tolerances. Refer to page 190 for details of applicable tolerance standards.

# Single-row tapered roller bearings

$d$  762.000 ~ 1 092.200 mm

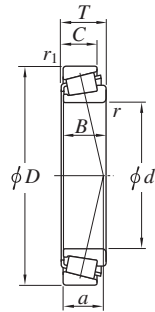

Design 1



Design 1-P

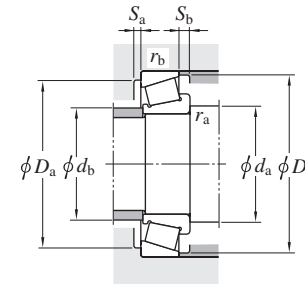

Boundary dimensions						Bearing No. <sup>1)</sup>	De- sign	Basic load ratings (kN)		Load center (mm) <i>a</i>	Mounting dimensions (mm)								Con- stant <i>e</i>	Axial load factors		(Refer.) Mass (kg)							
<i>d</i>	<i>D</i>	<i>T</i>	<i>B</i>	<i>C</i>	<i>r</i>			<i>r</i> <sub>1</sub>	<i>C</i> <sub>r</sub>		<i>C</i> <sub>0r</sub>	<i>d</i> <sub>a</sub>	<i>d</i> <sub>b</sub>	<i>D</i> <sub>a</sub>	<i>D</i> <sub>b</sub>	<i>S</i> <sub>a</sub>	<i>S</i> <sub>b</sub>	<i>r</i> <sub>a</sub>		<i>r</i> <sub>b</sub>	<i>Y</i> <sub>1</sub>		<i>Y</i> <sub>0</sub>						
mm	1/25.4	mm	1/25.4	mm	1/25.4			mm	1/25.4	min.	min.	min.	max.	max.	min.	min.	min.	max.	max.										
<b>762.000</b>	30.0000	889.000	35.0000	88.900	3.5000	88.900	3.5000	71.999	2.8346	3.2	3.2	<b>L183449/L183410</b>	1	1 860	5 630	123.1	780	785	870	860	870	11	16.9	3.2	3.2	0.31	1.97	1.08	88.8
	30.0000	965.200	38.0000	93.663	3.6875	80.963	3.1875	66.675	2.6250	6.4	3.2	<b>EE752300/752380</b>	1-P	1 830	4 790	159.7	785	820	940	910	920	1	27	6.4	3.2	0.40	1.49	0.82	143
<b>1 092.200</b>	43.0000	1 320.800	52.0000	95.250	3.7500	88.900	3.5000	69.850	2.7500	6.4	6.4	<b>EE776430/776520</b>	1-P	2 660	7 140	170.5	1 120	1 140	1 290	1 260	1 280	10	25.4	6.4	6.4	0.57	1.05	0.58	240

[Note] 1) While metric series bearings have minus tolerances for bore and OD, inch series have plus tolerances. Refer to page 190 for details of applicable tolerance standards.

# Double-row tapered roller bearings

TDI type

*d* 100 ~ 150 mm

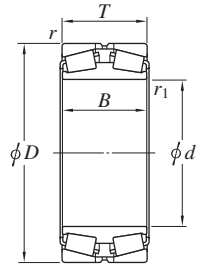

Design 1



Design 1-P

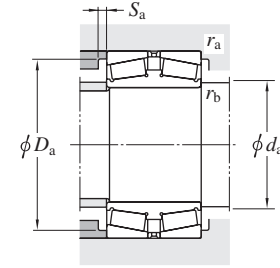

d mm	Boundary dimensions		Basic load ratings (kN)		Bearing No. <sup>1)</sup>	Design	Mounting dimensions (mm)						Constant <i>e</i>	Axial load factors			(Refer.) Mass (kg)							
	<i>D</i>	<i>B</i>	<i>T</i>	<i>r</i>			<i>r</i> <sub>1</sub>	<i>C<sub>r</sub></i>	<i>C<sub>0r</sub></i>	<i>d<sub>a</sub></i>	<i>D<sub>a</sub></i>	<i>S<sub>a</sub></i>		<i>r<sub>a</sub></i>	<i>r<sub>b</sub></i>	<i>Y<sub>2</sub></i>		<i>Y<sub>3</sub></i>	<i>Y<sub>0</sub></i>					
<b>100</b>	—	165	—	52	—	52	—	2	2.5	237	384	<b>45320</b>	1	119	155	148	3.9	2	2	0.35	1.95	2.90	1.91	4.26
<b>110</b>	—	180	—	56	—	56	—	2	2.5	300	505	<b>45322</b>	1	128	170	160	4	2	2	0.35	1.95	2.90	1.91	5.40
<b>120</b>	—	180	—	46	—	46	—	2	2.5	229	424	<b>45224</b>	1	138	170	163	4	2	2	0.26	2.55	3.80	2.50	4.08
	—	200	—	62	—	62	—	2	2.5	353	598	<b>45324</b>	1	142	190	178	4	2	2	0.35	1.95	2.90	1.91	7.92
<b>127.000</b>	5.0000	182.563	7.1875	76.200	3.0000	76.200	3.0000	3.2	1.6	389	858	<b>48290D/48220</b>	1	141	171	167	3.8	3.2	1.6	0.31	2.21	3.29	2.16	6.57
	5.0000	234.950	9.2500	139.700	5.5000	152.400	6.0000	3.2	5.2	897	1 650	<b>95499D/95925</b>	1	151	223	205	8	3.2	5.2	0.37	1.83	2.72	1.79	27.1
	5.0000	254.000	10.0000	161.925	6.3750	171.450	6.7500	6.4	3.2	1 190	2 010	<b>EE153053D/153100</b>	1	154	236	218	11	6.4	3.2	0.32	2.10	3.13	2.05	39.2
<b>130</b>	—	200	—	52	—	52	—	2	2.5	300	548	<b>45226</b>	1	152	190	179	4	2	2	0.27	2.47	3.67	2.41	5.96
	—	210	—	64	—	64	—	2	2.5	412	657	<b>45326</b>	1	153	200	185	4	2	2	0.36	1.87	2.79	1.83	8.41
<b>130.005</b>	5.1183	215.900	8.5000	123.825	4.8750	123.825	4.8750	3.2	1.6	551	1 100	<b>74510D/74850</b>	1	154	204	194	5	3.2	1.6	0.49	1.38	2.06	1.35	17.3
<b>133.350</b>	5.2500	196.850	7.7500	92.075	3.6250	92.075	3.6250	3.2	1.6	534	1 120	<b>67390D/67322</b>	1	146	185	181	5	3.2	1.6	0.34	1.96	2.92	1.92	9.46
	5.2500	203.200	8.0000	92.075	3.6250	92.075	3.6250	3.2	1.6	534	1 120	<b>67390D/67320</b>	1	146	191	181	5	3.2	1.6	0.34	1.96	2.92	1.92	10.9
<b>136.525</b>	5.3750	190.500	7.5000	77.788	3.0625	77.788	3.0625	3.2	1.6	405	944	<b>48393D/48320</b>	1	150	179	175	4.7	3.2	1.6	0.32	2.10	3.13	2.06	6.87
	5.3750	225.425	8.8750	120.650	4.7500	120.650	4.7500	3.2	1.6	811	1 610	<b>H228649D/H228610</b>	1	156	214	202	6	3.2	1.6	0.33	2.03	3.02	1.98	19.4
<b>139.700</b>	5.5000	200.025	7.8750	77.788	3.0625	75.408	2.9688	3.3	0.8	422	982	<b>48680D/48620</b>	1	155	188	183	4	3.3	0.8	0.34	2.01	2.99	1.96	8.01
<b>140</b>	—	210	—	53	—	53	—	2	2.5	311	564	<b>45228</b>	1	159	200	188	4	2	2	0.27	2.47	3.67	2.41	6.45
	—	225	—	68	—	68	—	2.5	3	486	807	<b>45328</b>	1	160	213	210	4	2	2.5	0.40	1.68	2.50	1.64	10.0
	—	250	—	88	—	88	—	3	4	615	915	<b>45T282509</b>	1	166	236	224	7.5	2.5	3	0.43	1.57	2.34	1.53	16.0
<b>149.225</b>	5.8750	254.000	10.0000	120.650	4.7500	120.650	4.7500	3.2	1.6	941	1 830	<b>99587D/99100</b>	1	172	242	224	8	3.2	1.6	0.41	1.66	2.47	1.62	26.0
<b>150</b>	—	225	—	56	—	56	—	2.5	3	355	686	<b>45230</b>	1	174	213	203	4	2	2.5	0.26	2.55	3.80	2.50	7.87
	—	225	—	75	—	75	—	2.5	1	510	965	<b>45T302308</b>	1	167	213	206	6.5	2	0.8	0.40	1.68	2.50	1.64	9.78
	—	250	—	80	—	80	—	2.5	3	593	955	<b>45330</b>	1	179	238	220	4	2	2.5	0.35	1.95	2.90	1.91	15.5
	—	250	—	100	—	100	—	2.5	3	768	1 510	<b>45T302510A</b>	1	179	238	226	6.5	2	2.5	0.40	1.68	2.50	1.64	20.0

[Note] 1) While metric series bearings have minus tolerances for bore and OD, inch series have plus tolerances. Refer to page 190 for details of applicable tolerance standards.

# Double-row tapered roller bearings

TDI type

$d$  152.400 ~ (190) mm

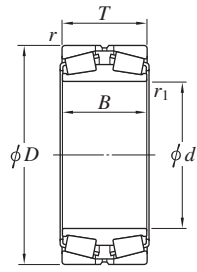

Design 1



Design 1-P

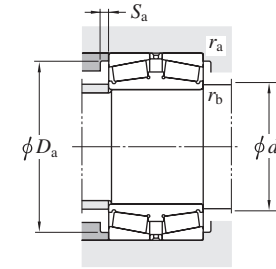

Boundary dimensions										Basic load ratings (kN)		Bearing No. <sup>1)</sup>	Design	Mounting dimensions (mm)						Constant	Axial load factors			(Refer.) Mass (kg)
$d$ mm		$D$ mm		$B$ mm		$T$ mm		$r$ min.	$r_1$ min.	$C_r$	$C_{Or}$			$d_a$ max.	$D_a$ max.	$S_a$ min.	$r_a$ max.	$r_b$ max.	$e$	$Y_2$	$Y_3$	$Y_0$		
152.400	6.0000	222.250	8.7500	84.138	3.3125	84.138	3.3125	1.6	1.6	541	1 190	<b>M231649D/M231610</b>						0.33	2.03	3.02	1.98	11.0		
	6.0000	254.000	10.0000	133.350	5.2500	133.350	5.2500	3.2	1.6	941	1 830	<b>99600D/99100</b>						0.41	1.66	2.47	1.62	27.2		
	6.0000	254.000	10.0000	158.750	6.2500	158.750	6.2500	3.2	1.6	941	1 830	<b>99603D/99100</b>						0.41	1.66	2.47	1.62	31.1		
160	—	240	—	60	—	60	—	2.5	3	421	705	<b>45232</b>						0.24	2.79	4.15	2.73	9.22		
	—	240	—	110	—	110	—	2.5	3	753	1 530	<b>45T322411</b>						0.33	2.03	3.02	1.98	16.7		
	—	270	—	86	—	86	—	2.5	3	678	1 100	<b>45332</b>						0.35	1.95	2.90	1.91	19.8		
170	—	260	—	67	—	67	—	2.5	3	521	956	<b>45234</b>						0.31	2.21	3.29	2.16	12.4		
	—	280	—	88	—	88	—	2.5	3	723	1 210	<b>45334</b>						0.33	2.03	3.02	1.98	21.6		
177.800	7.0000	247.650	9.7500	90.488	3.5625	90.488	3.5625	3.2	1.6	593	1 400	<b>67790D/67720</b>						0.44	1.54	2.29	1.50	13.3		
	7.0000	279.400	11.0000	112.710	4.4375	112.713	4.4375	3.2	1.6	828	1 640	<b>82680D/82620</b>						0.52	1.29	1.92	1.26	25.1		
	7.0000	285.750	11.2500	106.360	4.1874	106.363	4.1875	3.2	1.6	760	1 430	<b>EE91700D/91112</b>						0.43	1.57	2.34	1.53	26.0		
	7.0000	288.925	11.3750	123.825	4.8750	123.825	4.8750	3.2	1.6	943	1 920	<b>94706D/94113</b>						0.47	1.44	2.15	1.41	32.1		
	7.0000	288.925	11.3750	123.825	4.8750	123.825	4.8750	3.2	1.6	1 080	1 950	<b>HM237546D/HM237510</b>						0.32	2.12	3.15	2.07	30.8		
	7.0000	288.925	11.3750	158.750	6.2500	158.750	6.2500	3.2	1.6	1 080	1 950	<b>HM237546DD/HM237510</b>						0.32	2.12	3.15	2.07	37.0		
	7.0000	304.800	12.0000	109.438	4.3086	114.300	4.5000	3.2	3.2	974	1 690	<b>EE280700D/281200</b>						0.36	1.87	2.79	1.83	33.1		
180	—	254	—	90	—	90	—	2.5	3	572	1 270	<b>45T362509</b>						0.33	2.03	3.02	1.98	14.0		
	—	280	—	74	—	74	—	2.5	3	575	1 050	<b>45236</b>						0.28	2.43	3.61	2.37	16.8		
	—	300	—	96	—	96	—	3	4	860	1 370	<b>45336</b>						0.35	1.95	2.90	1.91	26.5		
	—	330	—	190	—	190	—	5	1.5	1 680	3 260	<b>45T363319</b>						0.58	1.17	1.75	1.15	71.8		
187.325	7.3750	269.875	10.6250	101.600	4.0000	101.600	4.0000	3.2	1.6	704	1 610	<b>M238849D/M238810</b>						0.33	2.03	3.02	1.98	19.0		
	7.3750	319.964	12.5970	168.275	6.6250	161.925	6.3750	4.8	3.2	1 280	2 450	<b>EE222074D/222126</b>						0.40	1.68	2.50	1.64	53.8		
	7.3750	319.964	12.5970	168.275	6.6250	161.925	6.3750	4.8	3.2	1 460	2 530	<b>H239649D/H239610</b>						0.32	2.12	3.15	2.07	51.4		
	7.3750	320.675	12.6250	168.275	6.6250	161.925	6.3750	4.8	3.2	1 280	2 450	<b>EE222074D/222128</b>						0.40	1.68	2.50	1.64	54.3		
	7.3750	320.675	12.6250	168.275	6.6250	161.925	6.3750	4.8	3.2	1 460	2 530	<b>H239649D/H239612</b>						0.32	2.12	3.15	2.07	51.9		
190	—	290	—	75	—	75	—	2.5	3	599	1 130	<b>45238</b>						0.26	2.55	3.80	2.50	17.7		
	—	300	—	140	—	140	—	2.5	1.5	1 010	2 110	<b>45T383014</b>						0.62	1.09	1.62	1.06	35.9		

[Note] 1) While metric series bearings have minus tolerances for bore and OD, inch series have plus tolerances. Refer to page 190 for details of applicable tolerance standards.

# Double-row tapered roller bearings

## TDI type

d (190) ~ 220 mm

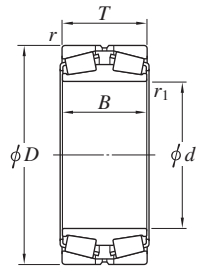

Design 1

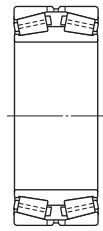

Design 1-P

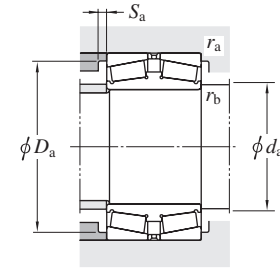

d	Boundary dimensions				Basic load ratings (kN)		Bearing No. 1)	Design	Mounting dimensions (mm)						Constant e	Axial load factors			Mass (kg)					
	mm	l/25.4	mm	l/25.4	mm	l/25.4			C <sub>r</sub>	C <sub>0r</sub>	d <sub>a</sub> max.	D <sub>a</sub> max.	S <sub>a</sub> min.	r <sub>a</sub> min.		r <sub>b</sub> max.	Y <sub>2</sub>	Y <sub>3</sub>		Y <sub>0</sub>				
190	—	320	—	104	—	104	—	3	4	981	1 590	<b>45338</b>	1	224	306	280	5	2.5	3	0.35	1.95	2.90	1.91	34.0
190.500	7.5000	365.049	14.3720	158.750	6.2500	152.400	6.0000	3.2	3.2	1 610	2 920	<b>EE420750D/421437</b>	1	239	353	317	6	3.2	3.2	0.40	1.68	2.50	1.64	77.2
	7.5000	368.300	14.5000	158.750	6.2500	152.400	6.0000	3.2	3.2	1 610	2 920	<b>EE420750D/421450</b>	1	239	356	317	6	3.2	3.2	0.40	1.68	2.50	1.64	79.4
199.975	7.8730	317.500	12.5000	133.350	5.2500	133.350	5.2500	3.2	6.4	1 040	2 270	<b>93788D/93125</b>	1	223	306	279	7	3.2	6.4	0.52	1.29	1.92	1.26	40.1
200	—	310	—	82	—	82	—	2.5	3	728	1 410	<b>45240</b>	1	234	298	280	5	2	2.5	0.26	2.55	3.80	2.50	22.9
	—	340	—	112	—	112	—	3	4	1 080	1 840	<b>45340</b>	1	244	326	300	5	2.5	3	0.35	1.95	2.90	1.91	41.9
	—	340	—	150	—	150	—	3	1.5	1 450	2 950	<b>45T403415</b>	1	233	326	301	9.5	2.5	1.5	0.43	1.57	2.34	1.53	57.7
203.200	8.0000	317.500	12.5000	123.825	4.8750	123.825	4.8750	3.2	1.6	1 040	2 270	<b>93800D/93125</b>	1	223	305	278	7	3.2	1.6	0.52	1.29	1.92	1.26	36.5
	8.0000	317.500	12.5000	133.350	5.2500	133.350	5.2500	3.2	6.4	1 040	2 270	<b>93801D/93125</b>	1	223	305	279	7	3.2	6.4	0.52	1.29	1.92	1.26	39.1
	8.0000	365.049	14.3720	158.750	6.2500	152.400	6.0000	3.2	3.2	1 610	2 920	<b>EE420800D/421437</b>	1	239	352	317	6	3.2	3.2	0.40	1.68	2.50	1.64	72.5
	8.0000	368.300	14.5000	158.750	6.2500	152.400	6.0000	3.2	3.2	1 610	2 920	<b>EE420800D/421450</b>	1	239	355	317	6	3.2	3.2	0.40	1.68	2.50	1.64	74.8
206.375	8.1250	282.575	11.1250	87.313	3.4375	87.313	3.4375	3.2	0.8	598	1 410	<b>67985D/67920</b>	1	220	270	260	7	3.2	0.8	0.51	1.33	1.97	1.30	16.1
	8.1250	336.550	13.2500	180.975	7.1250	184.150	7.2500	3.2	1.6	1 770	3 800	<b>H242649D/H242610</b>	1	233	324	301	9	3.2	1.6	0.33	2.03	3.02	1.98	65.1
215.900	8.5000	285.750	11.2500	85.725	3.3750	85.725	3.3750	3.2	0.8	611	1 560	<b>LM742749D/LM742710</b>	1	228	273	266	6	3.2	0.8	0.48	1.40	2.09	1.37	14.9
	8.5000	288.925	11.3750	85.750	3.3760	85.725	3.3750	3.2	0.8	611	1 560	<b>LM742749D/LM742714</b>	1	228	276	266	6	3.2	0.8	0.48	1.40	2.09	1.37	15.8
216.103	8.5080	330.200	13.0000	130.175	5.1250	127.000	5.0000	3.2	1.6	1 140	2 360	<b>9974D/9920</b>	1	237	317	301	7	3.2	1.6	0.55	1.22	1.82	1.19	38.8
	8.5080	330.200	13.0000	152.400	6.0000	142.875	5.6250	3.2	3.2	1 140	2 360	<b>9977D/9920</b>	1	239	317	301	7	3.2	3.2	0.55	1.22	1.82	1.19	43.3
218.000	—	314.325	—	115.888	—	115.888	—	3.2	1.6	1 120	2 550	<b>45T443112</b>	1	240	304	289	9	3.2	1.6	0.33	2.03	3.02	1.98	30.0
219.075	8.6250	358.775	14.1250	196.850	7.7500	200.025	7.8750	6.4	1.6	2 120	4 580	<b>H244849D/H244810</b>	1	245	340	320	9	6.4	1.6	0.33	2.03	3.02	1.98	80.9
220	—	320	—	76.2	—	76.2	—	2.5	3	779	1 570	<b>45T443208</b>	1	246	308	293	8.5	2	2.5	0.28	2.45	3.64	2.39	21.2
	—	340	—	90	—	90	—	3	4	805	1 460	<b>45244</b>	1	259	326	306	5	2.5	3	0.28	2.43	3.61	2.37	28.5
	—	370	—	120	—	120	—	4	5	1 210	2 060	<b>45344</b>	1	263	352	324	5	3	4	0.35	1.95	2.90	1.91	50.8
	—	400	—	250	—	254	—	4	1.5	3 110	5 970	<b>45T444025</b>	1-P	252	391	355	13	3	1.5	0.40	1.68	2.50	1.64	139

[Note] 1) While metric series bearings have minus tolerances for bore and OD, inch series have plus tolerances. Refer to page 190 for details of applicable tolerance standards.



# Double-row tapered roller bearings

## TDI type

$d$  220.663 ~ 254.000 mm

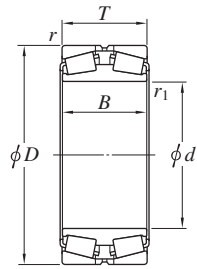

Design 1



Design 1-P

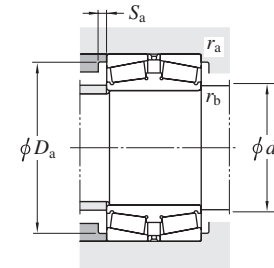

Boundary dimensions								Basic load ratings (kN)		Bearing No. <sup>1)</sup>	Design	Mounting dimensions (mm)						Constant $e$	Axial load factors			(Refer.) Mass (kg)
$d$ mm	$D$ mm	$B$ mm	$T$ mm	$r^{2)}$ min.	$r_1^{2)}$ min.	$C_r$	$C_{0r}$	$d_a$ max.	$D_a$ max.			$S_a$ min.	$r_a$ min.	$r_b$ max.	$Y_2$	$Y_3$	$Y_0$					
220.663	314.325	115.888	115.888	3.2	1.6	1 050	2 450	M244249D/M244210	1	241	301	289	5	3.2	1.6	0.33	2.03	3.02	1.98	29.0		
228.6	431.8	177.8	177.8	6	6	2 380	4 280	45T464318D	1-P	280	403	377	10	5	5	0.40	1.68	2.50	1.64	123		
228.600	400.050	139.700	139.700	3.2	3.2	1 560	2 950	EE529091D/529157	1	277	387	352	6	3.2	3.2	0.31	2.19	3.25	2.14	76.3		
230	350	90	90	3	4	791	1 560	45246	1	267	336	318	6	2.5	3	0.28	2.43	3.61	2.37	30.6		
234.950	327.025	93.663	93.663	3.2	1.6	802	1 860	8576D/8520	1	256	314	300	7	3.2	1.6	0.41	1.66	2.47	1.62	24.2		
	384.175	209.550	209.550	6.4	1.6	2 480	5 370	H247549D/H247510	1-P	262	365	342	8	6.4	1.6	0.33	2.03	3.02	1.98	99.3		
235	375	170	170	4	1.5	1 860	4 020	45T484012	1	268	366	338	8	3	1.5	0.33	2.03	3.02	1.98	73.7		
240	360	92	92	3	4	915	1 790	45248	1	271	346	325	5	2.5	3	0.32	2.12	3.15	2.07	32.2		
	400	128	128	4	5	1 430	2 470	45348	1	286	382	354	5	3	4	0.35	1.95	2.90	1.91	65.4		
	395	124	124	4	5	1 430	2 700	45T484012	1	283	373	358	10	3	4	0.40	1.68	2.50	1.64	60.3		
241.300	355.524	109.525	109.525	SP	SP	950	2 050	45T483611	1	267	336	319	6	2.5	2	0.35	1.91	2.84	1.86	37.0		
	355.600	92.710	92.862	3.2	1.6	870	1 850	EE170951D/171400	1	278	343	328	10	3.2	1.6	0.36	1.86	2.77	1.82	32.6		
	368.300	92.710	92.862	3.2	1.6	870	1 850	EE170951D/171450	1	278	355	328	10	3.2	1.6	0.36	1.86	2.77	1.82	37.8		
241.478	349.148	107.950	107.950	3.2	1.6	950	2 050	EE127097D/127135	1	268	336	320	7	3.2	1.6	0.35	1.91	2.84	1.86	34.0		
244.475	327.025	92.075	92.075	3.2	1.6	787	1 890	LM247748D/LM247710	1	265	314	306	7	3.2	1.6	0.32	2.10	3.13	2.06	21.5		
	381.000	146.050	146.050	4.8	3.2	1 350	2 930	EE126096D/126150	1	269	365	337	5	4.8	3.2	0.52	1.31	1.95	1.28	62.2		
247.650	400.050	119.060	114.300	6.4	1.6	1 300	2 570	EE220975D/221575	1	292	381	360	6	6.4	1.6	0.39	1.71	2.54	1.67	56.4		
	406.400	215.900	219.075	6.4	3.2	2 770	6 250	HH249949D/HH249910	1-P	279	387	362	11	6.4	3.2	0.33	2.03	3.02	1.98	116		
254.000	355.600	92.710	92.862	3.2	1.6	870	1 850	EE171000D/171400	1	278	343	328	10	3.2	1.6	0.36	1.86	2.77	1.82	29.1		
	358.775	130.175	130.175	3.2	3.2	1 330	3 170	M249748D/M249710	1	277	346	330.1	8	3.2	3.2	0.33	2.03	3.02	1.98	42.1		
	368.300	92.710	92.862	3.2	1.6	870	1 850	EE171000D/171450	1	278	355	328	10	3.2	1.6	0.36	1.86	2.77	1.82	34.2		
	444.500	133.350	133.350	6.4	3.2	1 470	2 770	EE822101D/822175	1	311	425	393	7	6.4	3.2	0.42	1.62	2.42	1.59	86.9		

[Notes] 1) While metric series bearings have minus tolerances for bore and OD, inch series have plus tolerances. Refer to page 190 for details of applicable tolerance standards.

2) SP indicates the specially chamfered form.

# Double-row tapered roller bearings

## TDI type

$d$  260 ~ 299.974 mm

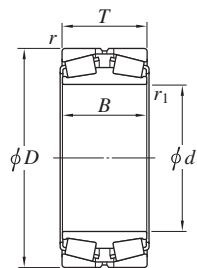

Design 1

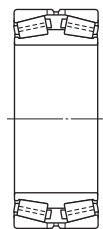

Design 1-P

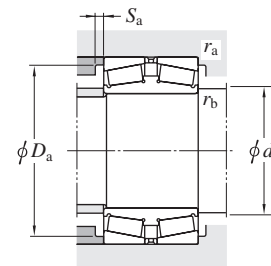

Boundary dimensions								Basic load ratings (kN)		Bearing No. 1)	Design	Mounting dimensions (mm)						Constant $e$	Axial load factors			(Refer.) Mass (kg)		
$d$ mm	$D$ mm	$B$ mm	$T$ mm	$r$ min.	$r_1$ min.	$C_r$	$C_{0r}$	$d_a$ max.	$D_a$ max.			$S_a$ min.	$r_a$ max.	$r_b$ max.	$Y_2$	$Y_3$	$Y_0$							
<b>260</b>	—	400	—	104	—	104	—	4	5	1 140	2 120	<b>45252</b>	1	302	382	360	6	3	4	0.25	2.74	4.08	2.68	48.1
	—	400	—	150	—	150	—	4	5	1 630	3 540	<b>45T524015</b>	1	294	382	361	9	3	4	0.33	2.03	3.02	1.98	70.0
	—	420	—	170	—	170	—	4	5	2 150	4 260	<b>45T524217</b>	1	297	402	381.5	11.5	3	4	0.33	2.03	3.02	1.98	92.5
	—	440	—	144	—	144	—	4	5	1 890	3 440	<b>45352</b>	1	313	422	386	6	3	4	0.35	1.95	2.90	1.91	92.2
<b>260.350</b>	10.2500	365.125	14.3750	107.950	4.2500	107.950	4.2500	6.4	3.2	970	2 150	<b>EE134102D/134143</b>	1	283	346	334.7	8	6.4	3.2	0.37	1.80	2.69	1.76	34.4
	10.2500	400.050	15.7500	119.060	4.6874	114.300	4.5000	6.4	6.4	1 300	2 570	<b>EE221025D/221575</b>	1	292	381	360	6	6.4	6.4	0.39	1.71	2.54	1.67	51.8
	10.2500	422.275	16.6250	152.400	6.0000	139.700	5.5000	3.2	3.6	1 730	3 360	<b>HM252347D/HM252310</b>	1	306	409	385	1	3.2	3.6	0.33	2.03	3.02	1.98	78.8
	10.2500	422.275	16.6250	155.575	6.1250	152.400	6.0000	3.2	6.4	1 730	3 360	<b>HM252348D/HM252310</b>	1	304	409	385	1	3.2	6.4	0.33	2.03	3.02	1.98	81.5
	10.2500	431.724	16.9970	148.433	5.8438	152.400	6.0000	3.6	6.4	1 730	3 360	<b>HM252348D/HM252315</b>	1	304	418	385	4	3.6	6.4	0.33	2.03	3.02	1.98	87.1
<b>266.700</b>	10.5000	355.600	14.0000	107.950	4.2500	109.538	4.3125	3.2	1.6	1 040	2 550	<b>LM451349D/LM451310</b>	1	285	343	332	8	3.2	1.6	0.36	1.87	2.79	1.83	29.5
	10.5000	393.700	15.5000	130.175	5.1250	130.175	5.1250	6.4	3.2	1 270	3 090	<b>EE275106D/275155</b>	1	309	374	365	5	6.4	3.2	0.40	1.68	2.50	1.64	55.3
<b>269.875</b>	10.6250	381.000	15.0000	136.525	5.3750	136.525	5.3750	3.2	3.2	1 460	3 350	<b>M252349D/M252310</b>	1	291	368	351	6	3.2	3.2	0.33	2.03	3.02	1.98	48.4
<b>276.225</b>	10.8750	393.700	15.5000	130.175	5.1250	130.175	5.1250	6.4	1.6	1 270	3 090	<b>EE275109D/275155</b>	1	309	374	365	5	6.4	1.6	0.40	1.68	2.50	1.64	51.2
	10.8750	406.400	16.0000	122.240	4.8126	130.175	5.1250	6.4	1.6	1 270	3 090	<b>EE275109D/275160</b>	1	309	387	366	9	6.4	1.6	0.40	1.68	2.50	1.64	57.2
<b>279.400</b>	11.0000	393.700	15.5000	127.000	5.0000	127.000	5.0000	6.4	1.6	1 200	2 780	<b>EE135111D/135155</b>	1	305	374	361	9	6.4	1.6	0.38	1.77	2.64	1.73	48.9
	11.0000	457.200	18.0000	244.475	9.6250	244.475	9.6250	6.4	1.6	3 300	7 540	<b>HH255149D/HH255110</b>	1	315	438	407	11	6.4	1.6	0.33	2.03	3.02	1.98	166
<b>279.578</b>	11.0070	380.898	14.9960	117.475	4.6250	117.475	4.6250	3.2	1.6	1 140	2 820	<b>LM654644D/LM654610</b>	1	303	368	357	7	3.2	1.6	0.43	1.57	2.34	1.53	38.9
<b>280</b>	—	420	—	106	—	106	—	4	5	1 190	2 470	<b>45256</b>	1	321	402	370	6	3	4	0.25	2.69	4.00	2.63	51.9
<b>285.750</b>	11.2500	380.898	14.9960	117.475	4.6250	117.475	4.6250	3.2	1.6	1 140	2 820	<b>LM654648D/LM654610</b>	1	303	368	357	7	3.2	1.6	0.43	1.57	2.34	1.53	36.4
<b>288.925</b>	11.3750	406.400	16.0000	144.463	5.6875	144.463	5.6875	3.2	3.2	1 720	4 420	<b>M255449D/M255410</b>	1	316	394	374	8	3.2	3.2	0.34	2.00	2.97	1.95	61.4
<b>292.100</b>	11.5000	422.275	16.6250	130.175	5.1250	130.175	5.1250	3.2	6.4	1 580	3 410	<b>EE330116D/330166</b>	1	321	409	388	7	3.2	6.4	0.32	2.11	3.14	2.06	59.9
<b>299.974</b>	11.8100	438.048	17.2460	133.350	5.2500	134.938	5.3125	4.8	3.2	1 350	3 230	<b>EE129119D/129172</b>	1	339	422	401	7	4.8	3.2	0.40	1.68	2.50	1.64	68.7

[Note] 1) While metric series bearings have minus tolerances for bore and OD, inch series have plus tolerances. Refer to page 190 for details of applicable tolerance standards.

# Double-row tapered roller bearings

TDI type

$d$  300 ~ 346.075 mm

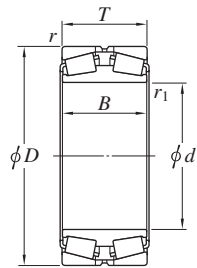

Design 1

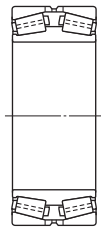

Design 1-P

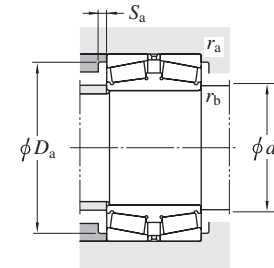

Boundary dimensions								Basic load ratings (kN)		Bearing No. <sup>1)</sup>	Design	Mounting dimensions (mm)						Constant $e$	Axial load factors			(Refer.) Mass (kg)		
$d$		$D$		$B$		$T$		$r^{2)}$ min.	$r_1^{2)}$ min.			$C_r$	$C_{0r}$	$d_a$ max.	$D_a$ max.	$S_a$ min.	$r_a$ max.		$r_b$ max.	$e$	$Y_2$		$Y_3$	$Y_0$
mm	1/25.4	mm	1/25.4	mm	1/25.4	mm	1/25.4																	
300	—	460	—	118	—	118	—	4	5	1 610	3 150	45260	1	350	442	418	6	3	4	0.25	2.74	4.08	2.68	78.5
	—	500	—	160	—	160	—	5	6	2 120	4 240			45360	1	356	478	440	6	4	5	0.35	1.95	2.90
300.038	11.8125	422.275	16.6250	150.813	5.9375	150.813	5.9375	3.2	3.2	1 700	4 030	HM256849D/HM256810	1	324	408	389	7	3.2	3.2	0.34	2.00	2.98	1.96	66.2
303.213	11.9375	495.300	19.5000	263.525	10.3750	263.525	10.3750	6.4	3.2	3 990	9 340	HH258249D/HH258210	1-P	342	475	442	8	6.4	3.2	0.33	2.03	3.02	1.98	207
304.648	11.9940	438.048	17.2460	131.763	5.1875	131.763	5.1875	3.2	3.2	1 510	3 450	EE329117D/329172	1	337	424	400	10	3.2	3.2	0.33	2.04	3.04	2.00	65.9
304.800	12.0000	419.100	16.5000	130.175	5.1250	130.175	5.1250	6.4	1.6	1 420	3 480	M257149D/M257110	1	331	399	388	7	6.4	1.6	0.33	2.03	3.02	1.98	53.8
	12.0000	444.500	17.5000	111.125	4.3750	107.950	4.2500	1.6	7.9	1 240	2 760	EE291200D/291750	1	344	434	404	11	1.6	7.9	0.38	1.79	2.66	1.75	58.7
	12.0000	495.300	19.5000	171.450	6.7500	165.100	6.5000	6.4	3.2	2 180	4 680	EE724121D/724195	1	355	475	439	6	6.4	3.2	0.40	1.68	2.50	1.64	130
304.902	12.0040	412.648	16.2460	128.588	5.0625	128.588	5.0625	3.2	3.2	1 370	3 340	M257248D/M257210	1	330	399	386	6	3.2	3.2	0.32	2.12	3.15	2.07	48.8
305.003	12.0080	438.048	17.2460	133.350	5.2500	134.938	5.3125	4.8	3.2	1 350	3 230	EE129123D/129172	1	339	421	401	7	4.8	3.2	0.40	1.68	2.50	1.64	66.2
305.054	12.0100	499.948	19.6830	200.000	7.8740	200.000	7.8740	6.4	3.2	2 810	5 820	HM858548D/HM858511	1	343	480	447	10	6.4	3.2	0.49	1.36	2.03	1.33	157
317.500	12.5000	447.675	17.6250	158.750	6.2500	158.750	6.2500	3.3	1.6	1 920	4 770	HM259049D/HM259010	1	346	434	412	10	3.3	1.6	0.33	2.02	3.00	1.97	80.2
320	—	450	—	110	—	110	—	3	4	1 270	2 760	45T644511	1-P	352	436	416	5	2.5	3	0.38	1.77	2.64	1.73	54.1
	—	480	—	121	—	121	—	4	5	1 630	3 180	45264	1	368	462	434	6	3	4	0.26	2.55	3.80	2.50	77.8
	—	540	—	176	—	176	—	5	6	2 690	5 280	45364R	1	378	518	474	6	4	5	0.32	2.12	3.15	2.07	167
333.375	13.1250	469.900	18.5000	166.688	6.5625	166.688	6.5625	3.2	3.2	2 320	5 680	HM261049D/HM261010	1-P	360	456	433	8	3.2	3.2	0.33	2.02	3.00	1.97	92.8
340	—	580	—	190	—	190	—	5	6	3 290	5 470	45368	1	401	558	515	6	4	5	0.32	2.12	3.15	2.07	202
342.900	13.5000	533.400	21.0000	139.690	5.4996	146.050	5.7500	3.2	3.2	1 870	3 580	EE971355D/972100	1	392	520	483	8	3.2	3.2	0.33	2.03	3.02	1.98	113
343.052	13.5060	457.098	17.9960	120.650	4.7500	120.650	4.7500	SP	SP	1 420	3 470	45T694612	1	363	438	425	7	2	0.8	0.47	1.43	2.12	1.40	40.0
346.075	13.6250	488.950	19.2500	174.625	6.8750	174.625	6.8750	3.2	3.2	2 310	5 800	HM262749D/HM262710	1	378	475	450	8	3.2	3.2	0.33	2.02	3.00	1.97	105

[Notes] 1) While metric series bearings have minus tolerances for bore and OD, inch series have plus tolerances. Refer to page 190 for details of applicable tolerance standards.

2) SP indicates the specially chamfered form.

# Double-row tapered roller bearings

TDI type

$d$  347.663 ~ 419.227 mm

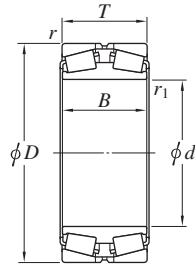

Design 1

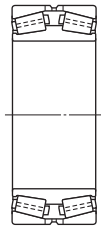

Design 1-P

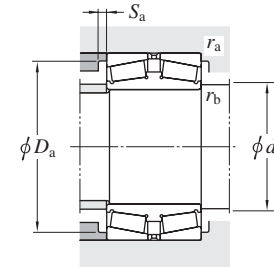

Boundary dimensions								Basic load ratings (kN)		Bearing No. 1)	Design	Mounting dimensions (mm)						Constant $e$	Axial load factors			(Refer.) Mass (kg)
$d$ mm	$D$ mm	$B$ mm	$T$ mm	$r^{2)}$ min.	$r_1^{2)}$ min.	$C_r$	$C_{0r}$	$d_a$ max.	$D_a$ max.			$S_a$ min.	$r_a$ max.	$r_b$ max.	$Y_2$	$Y_3$	$Y_0$					
347.663	469.900	138.113	138.113	3.2	3.2	1 800	4 520	M262449D/M262410	1	374	456	437	9	3.2	3.2	0.33	2.03	3.02	1.98	70.0		
355.600	444.500	112.713	114.300	3.2	1.6	1 110	3 450	L163149D/L163110	1	377	431	418	8	3.2	1.6	0.31	2.20	3.27	2.15	40.7		
	482.600	133.350	128.588	3.2	1.6	1 530	3 510	LM763449D/LM763410	1	381	469	451	4	3.2	1.6	0.47	1.43	2.14	1.40	67.7		
	501.650	127.000	111.125	3.2	3.2	1 350	3 280	EE231401D/231975	1	405	488	466	2	3.2	3.2	0.44	1.53	2.28	1.50	75.3		
360	540	134	134	5	6	2 050	3 910	45272	1	408	518	488	11	4	5	0.32	2.12	3.15	2.07	101		
	600	192	192	5	6	3 360	6 750	45372	1-P	419	578	528	10	4	5	0.32	2.12	3.15	2.07	228		
368.300	523.875	185.738	185.738	6.4	3.2	2 730	6 780	HM265049D/HM265010	1-P	403	500	484	7	6.4	3.2	0.33	2.03	3.02	1.98	110		
	609.600	254.000	279.400	6.4	3.2	4 310	9 060	EE321146D/321240	1	416	585	545	7	6.4	3.2	0.36	1.90	2.83	1.86	303		
374.574	546.100	193.675	193.675	6.4	3.2	3 260	8 430	HM266445D/HM266410	1-P	418	525	505	10	6.4	3.2	0.33	2.03	3.02	1.98	163		
380	560	135	135	5	6	2 060	3 790	45276	1	428	538	510	6	4	5	0.27	2.47	3.67	2.41	112		
	570	200	200	4	1.5	3 210	7 560	45T765720	1-P	418	552	520	11.5	3	1.5	0.47	1.43	2.12	1.40	183		
	620	194	194	5	6	3 070	6 360	45376	1	445	598	545	6	4	5	0.32	2.12	3.15	2.07	234		
384.175	546.100	193.675	193.675	6.4	3.2	3 260	8 430	HM266449D/HM266410	1-P	418	525	505	10	6.4	3.2	0.33	2.03	3.02	1.98	155		
	546.100	141.288	120.650	6.4	3.2	1 490	3 810	EE234157D/234215	1	437	525	497.6	1	6.4	3.2	0.48	1.42	2.11	1.39	96.0		
393.700	546.100	138.113	138.113	6.4	1.6	1 840	4 700	LM767745D/LM767710	1	435	525	510	9	6.4	1.6	0.48	1.42	2.11	1.39	99.0		
	546.100	141.288	120.650	6.4	3.2	1 490	3 810	EE234157D/234215	1	437	525	497.6	1	6.4	3.2	0.48	1.42	2.11	1.39	96.0		
400	600	148	148	5	6	2 410	4 960	45280	1	452	578	545	6	4	5	0.33	2.03	3.02	1.98	143		
	650	200	200	6	6	3 850	7 810	45380	1-P	458	622	580	11	5	5	0.39	1.74	2.59	1.70	265		
400.000	650.000	250.000	250.000	SP	SP	4 660	9 790	45T806525	1-P	460	620	585	13	5	5	0.39	1.74	2.59	1.70	328		
406.400	546.100	141.288	120.650	6.4	1.6	1 490	3 810	EE234161D/234215	1	437	520	497.6	1	6.4	1.6	0.48	1.42	2.11	1.39	88.6		
	546.100	138.113	138.113	6.4	1.6	1 840	4 700	LM767749D/LM767710	1	435	520	510	9	6.4	1.6	0.48	1.42	2.11	1.39	90.5		
415.925	590.550	209.550	209.550	6.4	3.2	3 390	8 930	M268749D/M268710	1-P	456	565	545	9	6.4	3.2	0.33	2.03	3.02	1.98	189		
419.227	736.448	406.400	406.400	6.4	6.4	8 700	19 000	EE323166D/323290	1-P	480.1	710	655	9	6.4	6.4	0.37	1.80	2.69	1.76	752		

[Notes] 1) While metric series bearings have minus tolerances for bore and OD, inch series have plus tolerances. Refer to page 190 for details of applicable tolerance standards.

2) SP indicates the specially chamfered form.

# Double-row tapered roller bearings

TDI type

d 420 ~ 501.650 mm

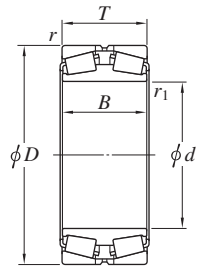

Design 1



Design 1-P

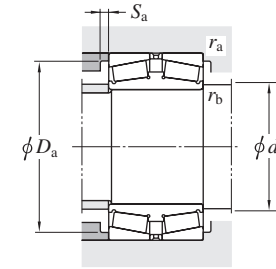

Boundary dimensions								Basic load ratings (kN)		Bearing No. <sup>1)</sup>	Design	Mounting dimensions (mm)					Constant e	Axial load factors			(Refer.) Mass (kg)				
d mm	1/25.4	D mm	1/25.4	B mm	1/25.4	T mm	1/25.4	r min.	r1 min.			Cr	Cor	da max.	Da max.	da min.		Da min.	ra max.	rb max.		Y2	Y3	Y0	
420	—	700	—	224	—	224	—	6	6	4 710	8 380	45384		1-P	488	672	623	7	5	5	0.39	1.74	2.59	1.70	352
431.800	17.0000	635.000	25.0000	173.038	6.8125	173.038	6.8125	6.4	6.4	3 150	6 870	EE931170D/931250		1-P	482	610	585	8	6.4	6.4	0.32	2.10	3.13	2.06	189
431.902	17.0040	685.698	26.9960	254.000	10.0000	253.873	9.9950	6.4	3.2	5 110	11 600	EE328172D/328269		1-P	484	660	620	11	6.4	3.2	0.40	1.68	2.50	1.64	370
432.003	17.0080	609.524	23.9970	152.400	6.0000	152.400	6.0000	6.4	3.6	2 600	6 060	EE736173D/736238		1	473	585	565	8	6.4	3.6	0.35	1.95	2.90	1.91	135
440	—	650	—	157	—	157	—	6	6	2 750	5 500	45288		1	500	622	592	10	5	5	0.28	2.43	3.61	2.37	182
	—	720	—	226	—	226	—	6	6	4 990	9 130	45388		1-P	506	692	642	7	5	5	0.39	1.74	2.59	1.70	367
447.675	17.6250	635.000	25.0000	223.838	8.8125	223.838	8.8125	6.4	3.2	3 930	10 500	M270748D/M270710		1-P	491	610	585	8	6.4	3.2	0.33	2.03	3.02	1.98	234
	17.6250	635.000	25.0000	223.838	8.8125	223.838	8.8125	6.4	3.2	3 930	10 500	M270749D/M270710		1-P	491	610	585	8	6.4	3.2	0.33	2.03	3.02	1.98	234
457.200	18.0000	596.900	23.5000	133.350	5.2500	130.175	5.1250	3.2	1.6	1 920	5 230	EE244181D/244235		1	488	580	555	7	3.2	1.6	0.40	1.67	2.48	1.63	98.1
	18.0000	596.900	23.5000	136.525	5.3750	133.350	5.2500	3.2	1.6	1 930	5 110	L770849D/L770810		1	488	580	560	7	3.2	1.6	0.47	1.43	2.12	1.40	99.9
	18.0000	660.400	26.0000	155.572	6.1249	155.575	6.1250	6.4	3.2	2 320	5 260	EE737179D/737260		1	500	635	600	7	6.4	3.2	0.37	1.80	2.69	1.76	175
460	—	680	—	163	—	163	—	6	6	3 000	5 660	45292		1	510	652	616	6	5	5	0.39	1.74	2.59	1.70	197
479.425	18.8750	679.450	26.7500	238.125	9.3750	238.125	9.3750	6.4	3.2	4 150	10 800	57567		1	520	655	630	7	6.4	3.2	0.33	2.03	3.02	1.98	267
	18.8750	679.450	26.7500	238.125	9.3750	238.125	9.3750	6.4	3.2	4 240	11 100	M272749D/M272710		1-P	520	655	630	7	6.4	3.2	0.33	2.03	3.02	1.98	277
480	—	700	—	165	—	165	—	6	6	3 060	6 710	45296		1-P	531	672	625	6	5	5	0.40	1.68	2.50	1.64	215
482.600	19.0000	615.950	24.2500	158.750	6.2500	158.750	6.2500	6.4	3.2	2 420	7 110	LM272249D/LM272210		1	510	590	585	8	6.4	3.2	0.33	2.03	3.02	1.98	117
489.026	19.2530	634.873	24.9950	153.988	6.0625	153.988	6.0625	3.2	3.2	2 460	6 840	LM772749D/LM772710		1	510	620	595	9	3.2	3.2	0.47	1.43	2.12	1.40	126
500	—	720	—	167	—	167	—	6	6	3 430	7 350	452/500		1-P	545	692	645	8	5	5	0.39	1.74	2.59	1.70	222
	—	870	—	385	—	385	—	10	3.5	9 550	21 900	2TR500-4		1-P	518	826	765	9	8	3	0.33	2.03	3.02	1.98	1 030
501.65	—	711.2	—	250.825	—	250.825	—	6.4	3.2	4 700	12 400	2TR502		1	515	683	656	10	6.4	3.2	0.33	2.03	3.02	1.98	322
501.650	19.7500	711.200	28.0000	250.825	9.8750	250.825	9.8750	6.4	3.2	4 810	12 800	M274149D/M274110		1-P	545	685	655	10	6.4	3.2	0.33	2.03	3.02	1.98	323

[Note] 1) While metric series bearings have minus tolerances for bore and OD, inch series have plus tolerances. Refer to page 190 for details of applicable tolerance standards.

# Double-row tapered roller bearings

## TDI type

d 508.000 ~ 635 mm

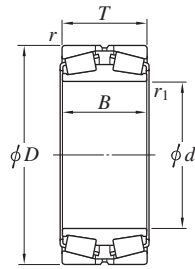

Design 1

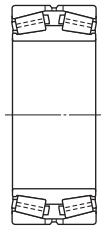

Design 1-P

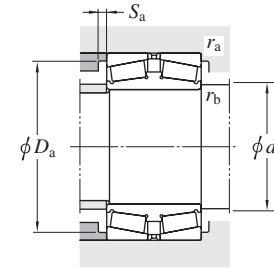

Boundary dimensions						Basic load ratings (kN)		Bearing No. <sup>1)</sup>	Design	Mounting dimensions (mm)						Constant e	Axial load factors			Mass (kg)						
d	D	B	T	r	r <sub>1</sub>	C <sub>r</sub>	C <sub>0r</sub>			d <sub>a</sub>	D <sub>a</sub>	S <sub>a</sub>	r <sub>a</sub>	r <sub>b</sub>	Y <sub>2</sub>		Y <sub>3</sub>	Y <sub>0</sub>								
mm	1/25.4	mm	1/25.4	mm	1/25.4	mm	1/25.4	min.	min.		max.	max.	min.	min.	max.	max.										
508.000	20.0000	762.000	30.0000	219.075	8.6250	219.075	8.6250	6.4	6.4	4 530	9 970	EE531201D/531300			1-P	560	740	695	11	6.4	6.4	0.38	1.78	2.65	1.74	354
	20.0000	838.200	33.0000	266.700	10.5000	266.700	10.5000	9.5	6.4	5 690	11 700	EE426201D/426330			1-P	580	810	755	7	9.5	6.4	0.48	1.41	2.10	1.38	585
510	—	655	—	184	—	184	—	6.4	1.5	3 160	9 590	2TR510-6			1	518	627	621	9	6.4	1.5	0.33	2.03	3.02	1.98	160
519.113	20.4375	736.600	29.0000	258.763	10.1875	258.763	10.1875	6.4	3.2	5 290	13 600	M275349D/M275310			1-P	560	710	680	10	6.4	3.2	0.33	2.03	3.02	1.98	361
520	—	735	—	111.125	—	260	—	5	6	5 290	13 600	2TR520C			1-P	548	713	681	11	4	5	0.33	2.03	3.02	1.98	356
530	—	780	—	185	—	185	—	6	6	4 070	8 870	452/530			1-P	591	752	710	8	5	5	0.39	1.74	2.59	1.70	306
	—	870	—	272	—	272	—	7.5	7.5	6 930	14 400	453/530			1-P	612	834	774	8	6	6	0.39	1.74	2.59	1.70	655
536.575	21.1250	761.873	29.9950	269.875	10.6250	269.875	10.6250	6.4	3.2	5 630	14 400	M276449D/M276410			1-P	575	740	700	9	6.4	3.2	0.33	2.03	3.02	1.98	401
540	—	710	—	150	—	140	—	4	5	2 650	6 620	2TR540			1-P	558	688	667	6	3	4	0.40	1.68	2.50	1.64	152
555.625	—	698.5	—	165.1	—	165.1	—	6.4	3.2	2 850	8 510	2TR555			1-P	569	670	662	10	6.4	3.2	0.33	2.03	3.02	1.98	151
558.800	22.0000	736.600	29.0000	196.850	7.7500	196.850	7.7500	6.4	3.2	3 590	9 870	LM377449D/LM377410			1-P	595	710	690	9	6.4	3.2	0.35	1.95	2.90	1.91	227
560	—	820	—	195	—	195	—	6	6	4 080	8 560	452/560			1-P	622	792	750	8	5	5	0.35	1.91	2.85	1.87	344
571.500	22.5000	812.800	32.0000	285.750	11.2500	285.750	11.2500	6.4	3.2	6 510	17 500	M278749D/M278710			1-P	620	790	750	11	6.4	3.2	0.33	2.03	3.02	1.98	497
595.313	23.4375	844.550	33.2500	296.863	11.6875	296.863	11.6875	6.4	3.2	6 780	18 500	M280049D/M280010			1-P	650	820	785	7	6.4	3.2	0.33	2.03	3.02	1.98	549
600	—	870	—	200	—	200	—	6	6	4 350	9 510	452/600			1-P	663	842	792	8	5	5	0.37	1.80	2.69	1.76	396
609.600	24.0000	787.400	31.0000	171.450	6.7500	171.450	6.7500	6.4	3.2	3 390	9 940	EE649241D/649310			1-P	645	760	740	12	6.4	3.2	0.37	1.82	2.70	1.78	223
630	—	1 030	—	315	—	315	—	7.5	7.5	9 150	19 400	453/630			1-P	733	994	915	8	6	6	0.39	1.74	2.59	1.70	1 060
635.000	25.0000	901.700	35.5000	317.500	12.5000	317.500	12.5000	6.4	3.2	7 480	19 900	M281049D/M281010			1-P	690	870	840	7	6.4	3.2	0.33	2.03	3.02	1.98	651
635	—	939.8	—	304.8	—	304.8	—	6.5	4	7 900	19 800	2TR635D			1-P	653	911	863	16	5	3	0.33	2.03	3.02	1.98	763

[Note] 1) While metric series bearings have minus tolerances for bore and OD, inch series have plus tolerances. Refer to page 190 for details of applicable tolerance standards.

# Double-row tapered roller bearings

## TDI type

$d$  670 ~ 939.800 mm

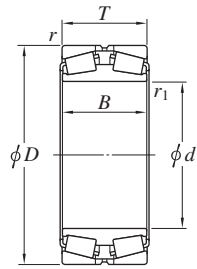

Design 1

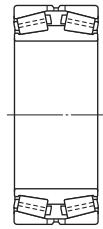

Design 1-P

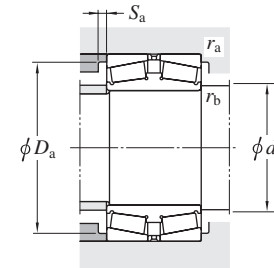

Boundary dimensions								Basic load ratings (kN)		Bearing No. <sup>1)</sup>	Design	Mounting dimensions (mm)						Constant $e$	Axial load factors			(Refer.) Mass (kg)		
$d$ mm	$D$ mm	$B$ mm	$T$ mm	$r$ min.	$r_1$ min.	$C_r$	$C_{0r}$	$d_a$ max.	$D_a$ max.			$S_a$ min.	$r_a$ max.	$r_b$ max.	$Y_2$	$Y_3$	$Y_0$							
670	—	980	—	230	—	230	—	7.5	7.5	6 100	13 800	<b>452/670</b>	1-P	746	944	895	8	6	6	0.39	1.74	2.59	1.70	595
685.800	27.0000	876.300	34.5000	171.450	6.7500	168.275	6.6250	6.4	3.2	3 510	10 800	<b>EE655271D/655345</b>	1-P	730	850	830	9	6.4	3.2	0.42	1.62	2.42	1.59	261
690	—	980	—	355	—	355	—	6	6	9 420	26 100	<b>2TR690A</b>	1-P	718	952	902	10	5	5	0.35	1.95	2.90	1.91	887
711.200	28.0000	914.400	36.0000	149.225	5.8750	149.225	5.8750	6.4	3.2	3 020	8 930	<b>EE755281D/755360</b>	1-P	770	890	870	8	6.4	3.2	0.38	1.78	2.65	1.74	256
714.375	28.1250	1 016.000	40.0000	339.725	13.3750	339.725	13.3750	6.4	3.2	9 740	26 100	<b>M383240D/M383210</b>	1-P	775	990	940	14	6.4	3.2	0.35	1.92	2.86	1.88	924
730.250	28.7500	1 035.050	40.7500	365.125	14.3750	365.125	14.3750	6.4	3.2	9 820	27 100	<b>M283449D/M283410</b>	1-P	790	1 010	960	10	6.4	3.2	0.33	2.03	3.02	1.98	1 000
749.300	29.5000	990.600	39.0000	293.000	11.5354	293.000	11.5354	6.4	3.2	7 850	23 900	<b>LM283649D/LM283610</b>	1-P	800	960	930	12	6.4	3.2	0.32	2.12	3.15	2.07	643
762.000	30.0000	1 079.500	42.5000	381.000	15.0000	381.000	15.0000	12.7	4.8	11 100	31 300	<b>M284249D/M284210</b>	1-P	830	1 040	1 000	11	12.7	4.8	0.33	2.03	3.02	1.98	1 140
800	—	1 100	—	300	—	300	—	6	3	7 620	21 700	<b>2TR800A</b>	1-P	814	1 072	1 016	12	5	2.5	0.80	0.85	1.26	0.83	863
810	—	1 280	—	430	—	430	—	9.5	4	14 800	38 600	<b>2TR810A</b>	1-P	828	1 236	1 166	21	8	3	0.41	1.66	2.47	1.62	2 250
825.500	32.5000	1 168.400	46.0000	409.575	16.1250	409.575	16.1250	12.7	4.8	13 000	36 200	<b>M285848D/M285810</b>	1-P	890	1 130	1 090	15	12.7	4.8	0.33	2.03	3.02	1.98	1 440
863.600	34.0000	1 130.300	44.5000	323.850	12.7500	323.850	12.7500	12.7	4.8	9 550	29 800	<b>LM286249D/LM286210</b>	1-P	920	1 090	1 070	15	12.7	4.8	0.32	2.08	3.10	2.04	896
	34.0000	1 219.200	48.0000	438.150	17.2500	425.450	16.7500	12.7	4.8	14 300	42 300	<b>EE547341D/547480</b>	1-P	940	1 180	1 130	9	12.7	4.8	0.33	2.03	3.02	1.98	1 660
939.800	37.0000	1 333.500	52.5000	463.550	18.2500	463.550	18.2500	12.7	4.8	16 700	47 700	<b>LM287849D/LM287810</b>	1-P	1 020	1 290	1 240	15	12.7	4.8	0.33	2.03	3.02	1.98	2 130

[Note] 1) While metric series bearings have minus tolerances for bore and OD, inch series have plus tolerances. Refer to page 190 for details of applicable tolerance standards.

# Double-row tapered roller bearings for axial support

## TDIS type

d 100 ~ 260.35 mm

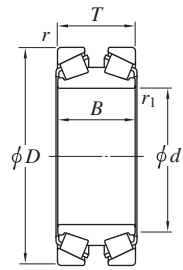

Design 1



Design 1-P

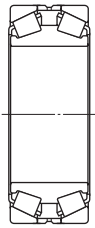

Design 2



Design 2-P

For oil mist lubrication



Design 3



Design 3-P

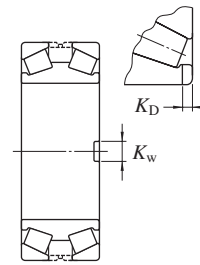

Face key way : A

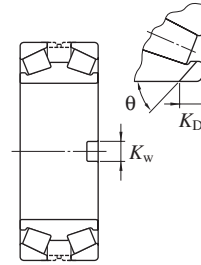

Face key way : B



Bore key way

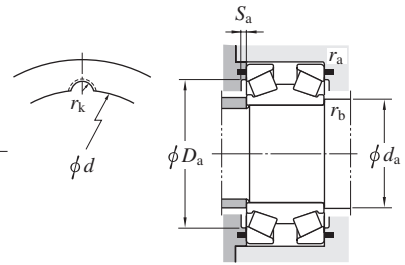

d	Boundary dimensions (mm)					Basic load ratings (kN)				Bearing No. <sup>1)</sup>	Design	Constant e	Axial load factors			Face key way					Bore key way R <sub>k</sub> (mm)	Mounting dimensions (mm)					Mass (kg)	
	D	B	T	r min.	r <sub>1</sub> <sup>3)</sup> min.	C <sub>r</sub>	C <sub>0r</sub>	C <sub>r</sub>	C <sub>0r</sub>				Y <sub>2</sub>	Y <sub>3</sub>	Y <sub>0</sub>	Type	K <sub>w</sub> (mm)	K <sub>D</sub> (mm)	θ (deg)	qty×Position <sup>2)</sup>		d <sub>a</sub> max.	D <sub>a</sub> max.	D <sub>a</sub> min.	S <sub>a</sub> min.	r <sub>a</sub> max.		r <sub>b</sub> max.
100	215	105	110	3	1	647	925	518	1 130	45T202211	2	0.81	0.84	1.25	0.82	B	20	18	45	2×2	—	119	184	163	5	2.5	1	18.3
	249.1	120	120	3	2.5	719	1 040	642	1 430	45T202512	2	0.9	0.75	1.12	0.73	—	—	—	—	—	—	127	202	178	4.5	2.5	2	30
110	240	118	118	3	1	730	1 040	593	1 290	45T222412	2	0.81	0.83	1.23	0.81	—	—	—	—	—	—	129	204	180	6	2.5	1	25.2
125	305	167	180	6.4	6	1 360	2 120	983	2 330	45T253018	2	0.73	0.93	1.38	0.91	—	—	—	—	—	—	173	261	233	8.5	5	5	65
	305	180	180	6.4	6	1 360	2 120	983	2 330	45T253018-1	2	0.73	0.93	1.38	0.91	A	30.2	11	—	1×2	—	164	257	227	2	5	5	66
160	342.9	160	160	3.3	SP	1 490	2 410	1 200	2 940	45T323416-2	1	0.81	0.83	1.24	0.82	B	30	25	45	2×2	—	190	282	253	5	3	2.5	66
170	360	144	160	4	5	1 340	2 100	1 460	3 440	45T303616-1	2	1.09	0.62	0.92	0.61	B	30	25	45	1×2	—	200	301	266	5	3	4	80
	360	144	160	4	2.5	1 340	2 100	1 460	3 440	45T343616A	2	1.09	0.62	0.92	0.61	—	—	—	—	—	—	201	301	266	5.5	3	2	70
180	320	104	104	4	1.5	789	1 350	647	1 690	45T363210	2	0.83	0.82	1.22	0.8	—	—	—	—	—	—	212	278	259	7.5	3	1.5	35
190	320	104	104	3	4	785	1 400	623	1 690	45T383210	2	0.8	0.85	1.26	0.83	—	—	—	—	—	—	212	281	262	5	2.5	3	30
	320	104	104	3	4	785	1 400	623	1 690	45T383210A	1	0.8	0.85	1.26	0.83	B	40	15	45	1×2	—	212	281	262	5	2.5	3	33
	320	114	114	4	2.5	881	1 570	759	2 070	45T383211A	2	0.87	0.78	1.16	0.76	A	38	10	—	1×2	—	216	282	260	6	3	2	33
190.09	265	58	58	2.5	1.5	327	662	292	910	45T382706	1	0.9	0.75	1.12	0.73	A	8.5	4	—	1×2	—	210	242	231	4	2	1.5	9
200	360	170	170	4	1.5	1 250	2 300	1 200	3 380	45T403617-1	2	0.96	0.7	1.04	0.68	A	30	17	—	2×2	—	230	307	270	—	3	1.5	65
	380	180	180	4	SP	1 780	3 240	1 410	3 900	45T403818	2-P	0.8	0.85	1.26	0.83	B	30	25	45	1×2	—	236	328	294	5.5	3	3	94
	380	180	180	4	SP	1 780	3 240	1 410	3 900	45T403818-1	2-P	0.8	0.85	1.26	0.83	B	30	25	45	2×2	—	236	328	294	5.5	3	3	94
220	360	120	120	3	4	1 000	1 920	863	2 530	45T443612/DP	2	0.87	0.78	1.16	0.76	B	40	25	45	1×2	—	250	317	294	6.5	2.5	3	47
228.6	431.8	177.8	177.8	6	SP	1 940	3 400	1 710	4 530	45T464318A-1	2-P	0.88	0.76	1.14	0.75	A	35	15	—	1×2	—	259	377	342	8.5	5	5	115
240	460	140	140	5	6	1 400	2 570	1 210	3 380	45T484614	2-P	0.87	0.78	1.16	0.76	A	50	15	—	2×2	—	293	389	364	3	4	5	95
260	459	155	155	4	5	1 570	2 780	1 360	3 650	45T524616	2-P	0.87	0.78	1.16	0.76	A	32.1	15	—	2×2	—	292	400	370	5.5	3	4	95
260.35	419.1	155.575	158.75	3.2	3.2	1 760	3 710	1 050	3 370	45T524216	2	0.6	1.12	1.67	1.1	B	40.2	18	45	1×2	—	291	374	349	7.5	3	3	85

[Notes] 1) Since there are many bearings of special tolerances for specific applications, consult with JTEKT for details of tolerances.

2) [×1]...one face, [×2]...both face.  
3) SP indicates the specially chamfered form.



# Double-row tapered roller bearings for axial support

## TDIS type

$d$  273.05 ~ 320 mm

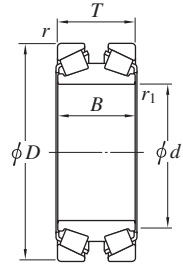

Design 1



Design 1-P

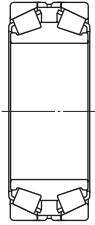

Design 2



Design 2-P

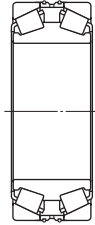

Design 3



Design 3-P

For oil mist lubrication

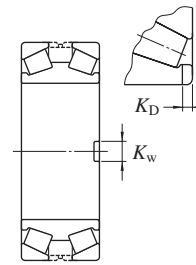

Face key way : A

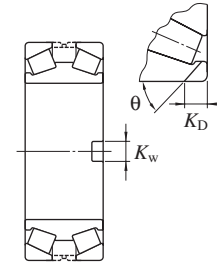

Face key way : B



Bore key way

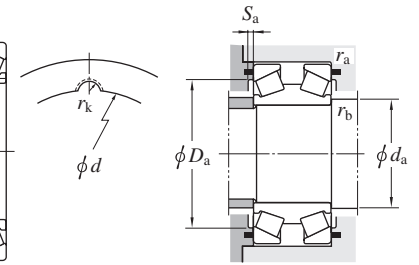

Boundary dimensions (mm)						Basic load ratings (kN)				Bearing No. <sup>1)</sup>	De-sign	Con-stant $e$	Axial load factors			Face key way					Bore key way $R_k$ (mm)	Mounting dimensions (mm)					Mass (kg)	
$d$	$D$	$B$	$T$	$r_{min.}$	$r_{1\ min.}$ <sup>3)</sup>	$C_r$	$C_{Or}$	$C_r$	$C_{Or}$				$Y_2$	$Y_3$	$Y_0$	Type	$K_w$ (mm)	$K_D$ (mm)	$\theta$ (deg)	qty×Position <sup>2)</sup>		$d_a$ max.	$D_a$ max.	$D_a$ min.	$S_a$ min.	$r_a$ max.		$r_b$ max.
273.05	393.7	130.175	130.175	6.4	1.6	1 190	2 760	824	2 930	45T553913	2	0.7	0.97	1.44	0.94	—	—	—	—	—	—	292	359	337	7.5	5	1.5	45
279.4	482.6	177.8	177.8	4.8	4.8	2 110	3 980	1 680	4 800	45T564818B	1-P	0.8	0.85	1.26	0.83	A	40	12	—	1×2	—	310	424	392	6.5	4	4	130
280	410	110	110	3	4	980	2 050	847	2 700	45T564111	2	0.87	0.78	1.16	0.76	—	—	—	—	—	—	308	371	350	5.5	2.5	3	48
285	380	92	92	2.5	1	758	1 820	654	2 400	45T573809B	1	0.87	0.78	1.16	0.76	B	32	13	45	1×2	—	303	352	334	5	2	1	28
298	419.5	120	120	4	2.5	1 100	2 440	946	3 210	45T604212-1	2	0.87	0.78	1.16	0.76	—	—	—	—	—	—	319	383	360	5	3	2	49
300	440	105	105	4	4	1 070	2 300	922	3 030	45T604411M	1-P	0.87	0.78	1.16	0.76	B	32.1	22.225	45	1×2	—	324	398	378	7.5	3	3	50
	440	105	105	3	4	969	2 480	835	3 260	45T604411N-1/DP1	2-P	0.87	0.78	1.16	0.76	B+C	32.131	22.225	45	—	6.477	334	395	374	6	2.5	3	57
	480	180	180	2.5	SP	1 780	4 300	1 540	5 650	45T604818	1	0.87	0.78	1.16	0.76	—	—	—	—	—	—	330	403	365	1	2	2.5	132
	500	160	160	5	SP	1 840	3 420	1 590	4 490	45T605016	1	0.87	0.78	1.16	0.76	B	52	25	45	1×2	—	327	439	410	7	4	5	110
	500	190	190	5	6	2 320	4 720	1 770	5 490	45T605019	1-P	0.76	0.88	1.31	0.86	B	50	30	45	1×2	—	339	440	405	3	4	5	142
	500	200	200	5	SP	2 320	4 720	1 770	5 490	45T605020-3	2-P	0.76	0.88	1.31	0.86	B	50	35	45	1×2	—	339	441	400	—	4	4	155
	520	180	180	5	SP	2 270	4 790	1 960	5 560	45T605218	1	0.87	0.78	1.16	0.86	B	50	30	45	2×2	—	340	443	408	8	4	4	151
	570	290	290	6	SP	3 810	8 280	3 290	10 900	45T605729	2-P	0.87	0.78	1.16	0.76	B	50	35	45	1×2	—	332	479	418	0.5	5	3	347
305	480	200	200	4	SP	2 060	4 670	1 780	6 140	45T614820-1	2	0.87	0.78	1.16	0.76	B	40	28	45	1×2	—	337	420	377	—	3	2.5	136
	500	200	200	5	6	2 320	4 720	1 770	5 490	45T615020	1-P	0.76	0.88	1.31	0.86	C	—	—	—	—	8.05	339	441	400	—	4	5	150
	500	200	200	5	6	2 320	4 720	1 770	5 490	45T615020-1	1-P	0.76	0.88	1.31	0.86	B	50.9	35	45	2×2	—	339	441	400	—	4	5	150
	500	200	200	5	6	2 320	4 720	1 770	5 490	45T615020B	1-P	0.76	0.88	1.31	0.86	B+C	50.9	35	45	1×2	8.05	339	441	400	—	4	5	150
	500	200	200	5	SP	2 320	4 720	1 770	5 490	45T615020D-2	1-P	0.76	0.88	1.31	0.86	C	51.3	35	45	1×2	8.05	339	441	400	—	4	4	146
	560	200	200	10	6.5	2 170	4 370	2 360	7 160	45T615620B	1	1.09	0.62	0.92	0.61	B	50.7	39.7	45	2×2	—	373	482	436	—	8	5	146
	560	200	200	20	6.5	2 170	4 370	2 360	7 160	45T615620D	1	1.09	0.62	0.92	0.61	A	50.8	19.05	—	2×2	—	373	482	436	—	10	5	146
	318	449.5	120	120	4	2.5	1 090	2 420	1 140	3 850	45T644512	2	1.05	0.64	0.96	0.63	B	20	8.5	—	1×2	—	342	408	381	5.5	3	2
320	480	160	160	2.5	SP	1 630	4 090	1 400	5 380	45T644816A	1	0.87	0.78	1.16	0.76	B	51.3	22	45	2×1	—	349	419	386	5	2	2.5	101
	540	176	176	5	SP	2 280	4 810	1 970	6 330	45T645418	2-P	0.87	0.78	1.16	0.76	B	40	35	45	1×2	—	363	476	442	6.5	4	4	166
	560	200	200	4	2.5	3 020	6 040	1 640	4 990	45T645620	1-P	0.55	1.24	1.84	1.21	B	50	30	45	1×2	—	374	491	464	9.5	3	2	204

[Notes] 1) Since there are many bearings of special tolerances for specific applications, consult with JTEKT for details of tolerances.

2) [×1]...one face, [×2]...both face.  
3) SP indicates the specially chamfered form.

# Double-row tapered roller bearings for axial support

## TDIS type

$d$  330 ~ (400) mm

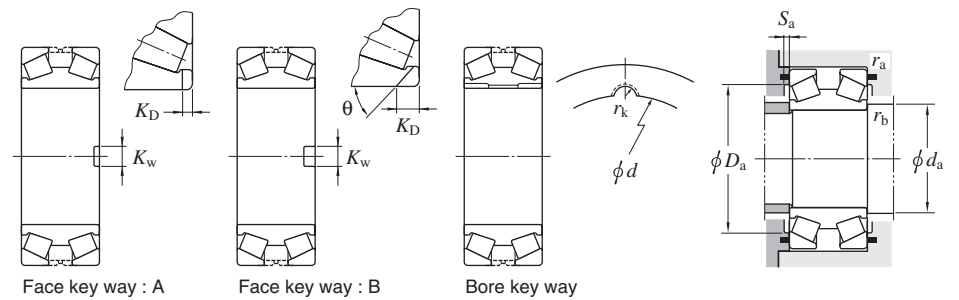
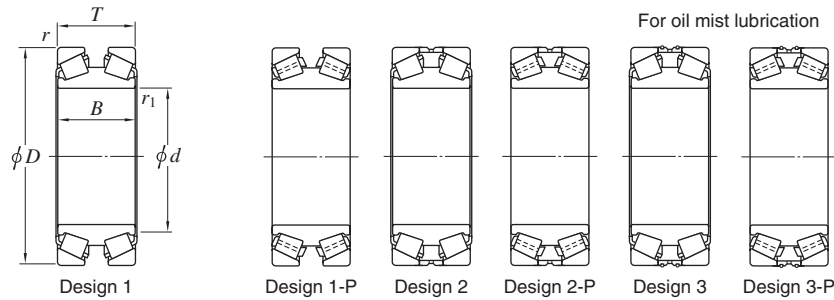

Boundary dimensions (mm)					Basic load ratings (kN)				Bearing No. 1)	De-sign	Con-stant e	Axial load factors			Face key way				Bore key way R <sub>k</sub> (mm)	Mounting dimensions (mm)					Mass (kg)			
$d$	$D$	$B$	$T$	$r^{3)}$ min.	$r_1^{3)}$ min.	$C_r$	$C_{0r}$	Radial $C_r$				Axial $C_{0r}$	$Y_2$	$Y_3$	$Y_0$	Type	$K_w$ (mm)	$K_D$ (mm)		$\theta$ (deg)	qtxxPosition <sup>2)</sup>	$d_a$ max.	$D_a$ max.	$D_a$ min.		$S_a$ min.	$r_a$ max.	$r_b$ max.
330	459	120	120	4	5	1050	2370	1090	3770	45T664612	2	1.05	0.64	0.96	0.63	A	32.1	12	—	2×2	—	354	421	393	5.5	3	4	55
340	550	135	135	5	2	1710	3520	1190	3750	45T685514	2	0.7	0.97	1.44	0.94	B+C	36	26	45	1×2	9	390	483	463	7	4	2	123
	590	192	192	SP	SP	2940	5870	2040	6240	45T685919-1	1-P	0.7	0.97	1.44	0.94	B	50	30	45	1×2	—	392	518	488	10	1	4	209
345	550	200	270	6	4	2430	5740	2090	7550	45T695520	1	0.87	0.78	1.16	0.76	A	32	16	—	1×2	—	373	482	440	2	5	3	176
350	590	192	192	5	SP	2820	5590	2430	7360	45T705919A-1	1-P	0.87	0.78	1.16	0.76	A	32	12	—	1×2	—	398	522	486	9	4	5	200
	590	192	192	5	SP	2540	6570	2760	10800	45T705919D	1-P	1.09	0.62	0.92	0.61	A	32	12	—	1×2	—	401	520	470	11.5	4	5	227
	619	200	200	6	6	2940	5580	2530	7340	45T706220	2-P	0.87	0.78	1.16	0.76	A	50	20	—	2×2	—	396	539	502	4.5	5	5	260
360	570	148	148	5	6	1930	3900	1340	4150	45T725715	1	0.7	0.97	1.44	0.94	B	50	23	45	1×2	—	394	498	472	7	4	5	131
365.6	514.35	140	140	4	SP	1390	3730	1190	4910	45T735114A	1	0.87	0.78	1.16	0.76	B	40	20	45	2×2	—	394	457	428	5.5	3	2.5	89
374.65	501.65	120.65	130.175	6	3.3	1270	3160	1090	4160	45T755013A	1	0.87	0.78	1.16	0.76	B	50	10	—	1×2	—	399	463	436	2.5	5	3	67
380	550	255	205	SP	SP	2850	7340	1550	6070	45T765526	3-P	0.55	1.24	1.84	1.21	A	32	15	—	1×2	—	391	499	470	7.5	1	4	182
	560	190	190	2	2	2860	7220	1560	5970	45T765619	1-P	0.55	1.24	1.84	1.21	B	32	12	60	1×2	—	415	509	482	10.5	2	2	187
	560	200	200	4	4	2750	7020	1660	6440	45T765620	1-P	0.61	1.11	1.66	1.09	B	40.1	21	45	1×2	—	416	505	473	4	3	3	167
	570	200	200	4	SP	2780	6620	1930	7040	45T765720A	2-P	0.7	0.97	1.44	0.94	A	32	11.7	—	1×2	—	406	513	478	1.5	3	3	178
	650	240	240	6	5	3830	8260	3040	9950	45T766524	2-P	0.8	0.85	1.26	0.83	B	50	15	45	—	—	442	572	528	9.5	5	4	290
	650	240	240	6	SP	3830	8260	3040	9950	45T766524-2	2-P	0.8	0.85	1.26	0.83	B	50.5	40	45	2×2	—	442	572	528	9.5	5	5	335
381	695	280	280	6	SP	4780	9970	4120	13100	45T767028A	2-P	0.87	0.78	1.16	0.76	B	50	45	45	2×2	—	448	602	547	10	5	5	479
390	548	180	180	4	SP	2050	5540	1770	7290	45T765518	1	0.87	0.78	1.16	0.76	B	51.3	16	45	1×2	—	418	495	457	3	3	2.5	169
	562	180	180	4.5	SP	2110	5530	1820	7280	45T785618	1	0.87	0.78	1.16	0.76	A	32	11.7	—	2×2	—	420	501	463	4.5	4	2.5	145
	570	180	180	2.5	SP	2110	5530	1820	7280	45T785718A	1	0.87	0.78	1.16	0.76	B	51.3	22	45	2×2	—	420	501	463	4.5	2	2.5	149
	600	200	200	5	6	2610	6070	2250	7990	45T786020	2-P	0.87	0.78	1.16	0.76	—	—	—	—	7.5	424	539	500	2.5	4	5	202	
400	600	148	148	5	6	1820	4040	1410	4750	45T806015A	1	0.78	0.86	1.29	0.85	B	50	25	45	1×2	—	432	531	505	9.5	4	5	131
	650	200	200	6	6	2930	6500	2520	8560	45T806520D	1	0.87	0.78	1.16	0.76	A	50.8	19	—	2×2	—	465	582	542	4.5	5	5	243
	650	240	240	6	SP	3770	8390	3250	11000	2TR400L	1-P	0.87	0.78	1.16	0.76	B	64.3	32	45	1×2	—	437	580	534	5.5	5	2	296

[Notes] 1) Since there are many bearings of special tolerances for specific applications, consult with JTEKT for details of tolerances.

2) [×1]---one face, [×2]---both face.

3) SP indicates the specially chamfered form.

Double-row tapered roller bearings for axial support

TDIS type

d (400) ~ 510 mm

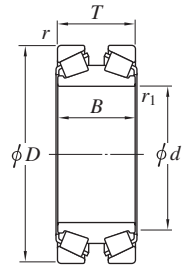

Design 1



Design 1-P

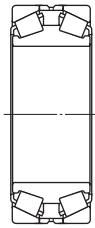

Design 2



Design 2-P

For oil mist lubrication

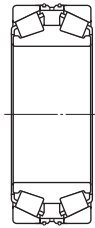

Design 3



Design 3-P

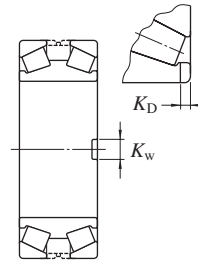

Face key way : A

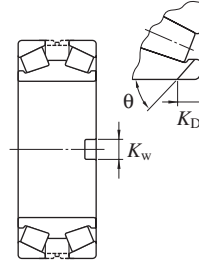

Face key way : B

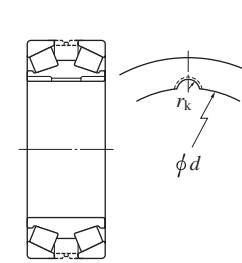

Bore key way

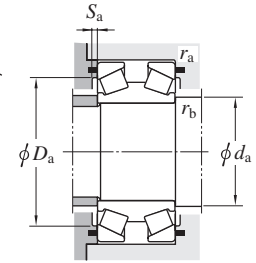

d	Boundary dimensions (mm)				Basic load ratings (kN)				Bearing No. 1)	De-sign	Constant e	Axial load factors			Face key way				Bore key way R <sub>k</sub> (mm)	Mounting dimensions (mm)					Mass (kg)			
	D	B	T	r <sup>3)</sup> min.	r <sub>1</sub> <sup>3)</sup> min.	C <sub>r</sub>	C <sub>0r</sub>	C <sub>r</sub>				C <sub>0r</sub>	Y <sub>2</sub>	Y <sub>3</sub>	Y <sub>0</sub>	Type	K <sub>w</sub> (mm)	K <sub>D</sub> (mm)		θ (deg)	Qty x Position <sup>2)</sup>	d <sub>a</sub> max.	D <sub>a</sub> max.	D <sub>a</sub> min.		S <sub>a</sub> min.	r <sub>a</sub> max.	r <sub>b</sub> max.
400	650	240	240	6	SP	3 770	8 390	3 250	11 000	<b>2TR400L-4/DP</b>	3-P	0.87	0.78	1.16	0.76	B	64.3	32	45	1×2	—	437	580	534	5.5	5	2	308
406.4	546.1	138.112	138.112	6.4	SP	1 490	3 920	1 280	5 160	<b>45T815514</b>	1	0.87	0.78	1.16	0.76	A	50	11	—	1×2	—	436	502	474	5	5	3	89
410	580	160	160	4	7	2 180	5 430	1 880	7 140	<b>45T825816A-1</b>	2	0.87	0.78	1.16	0.76	A	50.8	10	—	1×2	—	434	532	500	9	3	5	133
430	535	84	84	3	SP	830	2 270	715	2 990	<b>45T865408</b>	2	0.87	0.78	1.16	0.76	B	20	15	45	1×2	—	456	503	486	5	2.5	2	42
	600	200	200	4	3	3 060	8 230	1 450	5 880	<b>45T866020</b>	1-P	0.47	1.43	2.12	1.4	A	50	19	45	1×2	—	466	552	527	6.5	3	2.5	172
440	650	155	155	6	SP	2 220	5 110	1 910	6 720	<b>45T886516A</b>	2-P	0.87	0.78	1.16	0.76	SP	50	15	45	1×2	—	484	593	564	8	5	4	172
445	620	160	160	4	2.5	2 130	5 060	1 830	6 650	<b>45T896216</b>	1-P	0.87	0.78	1.16	0.76	B	51.3	31.75	45	1×2	—	476	566	536	3.5	3	2	136
450	820	300	300	7.5	7.5	4 990	10 000	5 200	15 900	<b>45T908230U</b>	1-P	1.05	0.64	0.96	0.63	A	40	25	—	1×2	—	540	713	650	2.5	6	6	610
	830	320	320	7.5	7.5	5 570	10 900	5 800	17 200	<b>45T908332-1</b>	1-P	1.05	0.64	0.96	0.63	B	60	55	45	2×2	—	501	706	636	1	6	6	691
460	619	150	150	4	4	1 820	4 640	1 900	7 370	<b>45T926215</b>	2	1.05	0.64	0.96	0.63	A	50	15	—	2×2	—	486	569	536	4	3	3	125
470	700	270	270	5	SP	2 980	7 850	2 890	11 500	<b>45T947027A</b>	2	0.97	0.69	1.03	0.68	B	50	35	45	1×2	—	518	607	544	—	4	3	358
	720	216	216	6	6	3 300	7 360	3 590	12 100	<b>45T947222/DP</b>	3-P	1.09	0.62	0.92	0.61	B	63.6	30	45	1×2	—	515	646	600	7	5	5	309
482	655	160	170	4	4	1 890	5 270	1 630	6 930	<b>45T966616-1</b>	1	0.87	0.78	1.16	0.76	B	40	20	45	2×2	—	518	590	554	—	3	3	157
482.6	733.5	190	190	SP	SP	3 230	8 000	2 620	9 880	<b>45T977319</b>	1-P	0.81	0.83	1.23	0.81	B	64.2	44.45	45	1×2	—	547	669	635	7.5	2	2	283
	733.501	200.025	200	6.4	6.4	2 950	7 100	3 200	11 600	<b>45T977320C</b>	1-P	1.09	0.62	0.92	0.61	B+C	50.8	38.1	45	2×2	8.05	513	651	603	5	5	5	283
	733.501	200.025	200	17.5	6.4	2 950	7 100	3 200	11 600	<b>45T977320D</b>	1-P	1.09	0.62	0.92	0.61	A	50.8	19.05	—	2×2	—	513	651	603	5	10	5	280
	733.501	200.025	200	17.5	6.4	2 950	7 100	3 200	11 600	<b>45T977320J</b>	1-P	1.09	0.62	0.92	0.61	A	50.8	19.05	—	1×2	—	513	651	603	5	10	5	280
500	820	256	256	7.5	7.5	4 960	11 700	3 780	13 600	<b>2TR500-3</b>	2-P	0.76	0.88	1.31	0.86	B	50.8	38.1	45	2×2	—	561	718	672	9.5	6	6	559
	900	400	400	7.5	5	8 240	19 500	8 580	30 900	<b>2TR500J</b>	1-P	1.05	0.64	0.96	0.63	B	50	40	45	1×2	—	560	774	680	11	6	6	1 090
509.998	733.5	200.02	200.02	5	6	3 230	8 000	2 620	9 880	<b>2TR510L-1</b>	1-P	0.81	0.83	1.23	0.81	B	50.8	38.1	45	2×2	—	560	667	630	3.5	4	5	261
510	800	285	285	6	SP	5 370	12 300	4 260	14 800	<b>2TR510-2</b>	1-P	0.8	0.85	1.26	0.83	B	70.2	44.45	45	1×2	—	570	716	662	7	6	6	506

[Notes] 1) Since there are many bearings of special tolerances for specific applications, consult with JTEKT for details of tolerances.

2) [×1]---one face, [×2]---both face.

3) SP indicates the specially chamfered form.

# Double-row tapered roller bearings for axial support

## TDIS type

$d$  600 ~ 900 mm

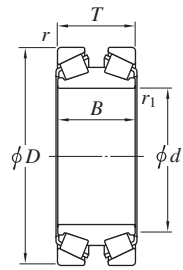

Design 1



Design 1-P

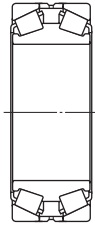

Design 2



Design 2-P

For oil mist lubrication

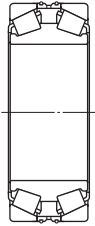

Design 3



Design 3-P

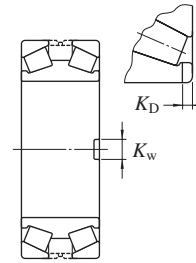

Face key way : A

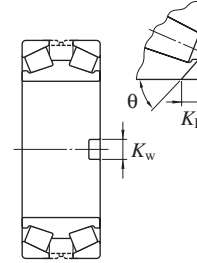

Face key way : B

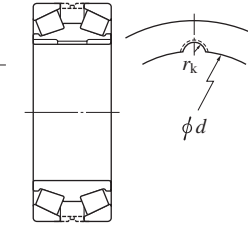

Bore key way

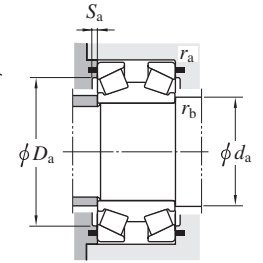

Boundary dimensions (mm)						Basic load ratings (kN)				Bearing No. <sup>1)</sup>	De-sign	Con-stant $e$	Axial load factors			Face key way				Bore key way $R_k$ (mm)	Mounting dimensions (mm)						Mass (kg)	
$d$	$D$	$B$	$T$	$r^{(3)}$ min.	$r_1^{(3)}$ min.	$C_r$	$C_{0r}$	$C_r$	$C_{0r}$				$Y_2$	$Y_3$	$Y_0$	Type	$K_w$ (mm)	$K_D$ (mm)	$\theta$ (deg)		QtyxPosition <sup>2)</sup>	$d_a$ max.	$d_a$ max.	$D_a$ min.	$S_a$ min.	$r_a$ max.		$r_b$ max.
600	1 000	350	350	7.5	SP	8 390	18 500	6 400	21 500	2TR600-2	2-P	0.76	0.88	1.31	0.86	C	—	—	—	—	1.5	690	886	825	7.5	6	8	1 110
620	1 020	360	360	7.5	SP	8 430	19 800	7 260	26 100	2TR620	1-P	0.87	0.78	1.16	0.76	B	90	65	45	1x2	—	708	901	832	5	6	5	1 140
630	789	150	150	4	5	1 980	6 180	1 710	8 140	2TR630B	2-P	0.87	0.78	1.16	0.76	—	—	—	—	—	—	660	736	706	5	3	4	169
635	940	260	260	5.4	3.2	4 570	10 600	5 320	19 000	2TR635B-1	1-P	1.17	0.58	0.86	0.56	B	70.3	51	45	1x2	—	674	852	793	—	5	3	477
660	814	176.212	176.212	6.4	SP	2 620	8 780	1 820	9 340	2TR660C	1	0.7	0.97	1.44	0.94	B	50	20	45	1x2	—	686	766	735	5	5	2.5	196
685.8	939.8	235	228.6	SP	SP	4 930	12 800	3 760	14 900	2TR686A	1-P	0.76	0.88	1.31	0.86	B	63.6	38.5	45	1x2	—	730	868	827	8.5	1	3	455
	939.8	234.95	227.81	6.4	SP	4 390	13 000	3 780	17 200	2TR686C	1-P	0.87	0.78	1.16	0.76	B	80	38.1	45	2x2	—	745	865	819	6.5	5	3	464
717.55	1 000	200	200	6	SP	4 070	12 400	3 510	16 300	2TR718	1-P	0.87	0.78	1.16	0.76	B	70.3	44.5	45	1x2	—	800	914	874	9	5	5	482
780	1 000	200	200	5	2	4 090	12 800	3 250	15 400	2TR780A	1-P	0.8	0.85	1.26	0.83	B	90	35	45	1x2	—	830	937	900	8	4	2	381
900	1 220	300	300	12	3	7 930	23 200	6 840	30 500	2TR900-1	1-P	0.87	0.78	1.16	0.76	B	89.5	51	45	1x2	—	955	1 129	1 070	14	8	2.5	1 020

[Notes] 1) Since there are many bearings of special tolerances for specific applications, consult with JTEKT for details of tolerances.

2) [x1]...one face, [x2]...both face.

3) SP indicates the specially chamfered form.

# Double-row tapered roller bearings (Tapered bore)

## TDIT type

$d$  127.000 ~ 280.000 mm

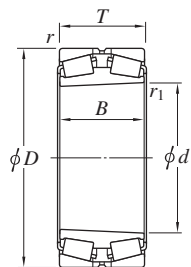

Design 1



Design 1-P

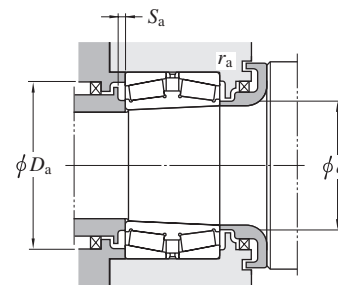

Boundary dimensions								Basic load ratings (kN)		Bearing No. <sup>1)</sup>	Design	Mounting dimensions (mm)						Constant $e$	Axial load factors			Mass (kg)
$d$	$D$	$B$	$T$	$r$	$r_1$	$C_r$	$C_{0r}$	$d_a$	$D_a$			$S_a$	$r_a^{2)}$	$r_b^{2)}$	$e$	$Y_2$	$Y_3$		$Y_0$			
mm	mm	mm	mm	mm	mm	mm	mm	max.	max.			min.	min.	max.								
127.000	182.563	76.200	76.200	3.2	1.6	389	858	141	171	166	3.8	3.2	1.6	0.31	2.21	3.29	2.16	6.57				
133.350	196.850	92.075	92.075	3.2	1.6	534	1 120	146	185	180	5	3.2	1.6	0.34	1.96	2.92	1.92	9.46				
136.525	215.900	123.825	123.825	3.2	1.6	551	1 100	154	204	193	5	3.2	1.6	0.49	1.38	2.06	1.35	15.9				
142.875	200.025	74.613	77.788	3.3	0.8	422	982	156	188	182	4	3.3	0.8	0.34	2.01	2.99	1.96	7.58				
147.638	241.300	132.334	133.351	3.2	1.6	719	1 460	166	229	211	7	3.2	1.6	0.44	1.53	2.27	1.49	23.6				
152.400	254.000	120.650	120.650	3.2	1.6	941	1 830	172	242	223	8	3.2	1.6	0.41	1.66	2.47	1.62	25.3				
165.100	269.875	146.050	146.050	3.2	1.6	1 140	2 220	187	258	243	5	3.2	1.6	0.33	2.03	3.02	1.98	32.2				
180.975	288.925	158.750	158.750	3.2	1.6	943	1 920	201	277	255	8	3.2	1.6	0.47	1.44	2.15	1.41	38.0				
	288.925	158.750	158.750	3.2	1.6	1 080	1 950	201	277	260	8	3.2	1.6	0.32	2.12	3.15	2.07	35.9				
190.500	365.049	152.400	158.750	3.2	3.2	1 610	2 920	239	353	317	6	3.2	3.2	0.40	1.68	2.50	1.64	77.2				
198.438	282.575	87.313	87.313	3.2	0.8	598	1 410	220	271	259	7	3.2	0.8	0.51	1.33	1.97	1.30	17.8				
209.550	317.500	184.150	184.150	3.2	1.6	1 040	2 270	223	306	278	7	3.2	1.6	0.52	1.29	1.92	1.26	48.3				
219.075	358.775	200.025	196.850	6.4	1.6	2 120	4 580	245	340	319	9	6.4	1.6	0.33	2.03	3.02	1.98	80.9				
222.250	355.600	130.175	127.000	3.2	1.6	1 130	2 630	253	343	312	8	3.2	1.6	0.59	1.14	1.70	1.12	50.9				
252.413	358.775	139.700	130.175	3.2	1.6	1 330	3 170	275	346	330	8	3.2	1.6	0.33	2.03	3.02	1.98	43.5				
263.525	400.050	192.088	196.848	6.4	1.6	1 300	2 570	292	381	359	6	6.4	1.6	0.39	1.71	2.54	1.67	76.7				
266.700	355.600	109.538	107.950	3.2	1.6	1 040	2 550	285	343	332	8	3.2	1.6	0.36	1.87	2.79	1.83	29.5				
280.000	406.400	206.375	206.375	3.2	3.2	1 310	2 950	308	394	368	7	3.2	3.2	0.39	1.75	2.61	1.71	81.4				

[Notes] 1) While metric series bearings have minus tolerances for bore and OD, inch series have plus tolerances. Refer to page 190 for details of applicable tolerance standards.

2)  $r_a$  indicates housing chamfer dimension corresponding to outer ring chamfer dimension  $r$ .  $r_b$  indicates the shaft chamfer dimension corresponding to inner ring chamfer dimension  $r_1$ .

# Double-row tapered roller bearings (Tapered bore)

## TDIT type

*d* 288.925 ~ 519.113 mm

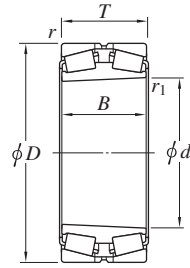

Design 1



Design 1-P

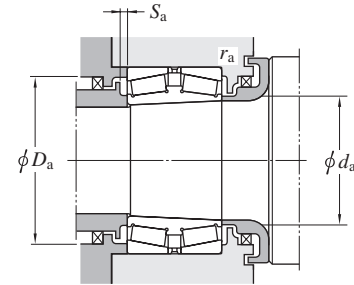

Boundary dimensions						Basic load ratings (kN)		Bearing No. <sup>1)</sup>	Design	Mounting dimensions (mm)						Constant <i>e</i>	Axial load factors			Mass (kg)				
<i>d</i>	<i>D</i>	<i>B</i>	<i>T</i>	<i>r</i>	<i>r</i> <sub>1</sub>	<i>C<sub>r</sub></i>	<i>C<sub>0r</sub></i>			<i>d<sub>a</sub></i>	<i>D<sub>a</sub></i>	<i>S<sub>a</sub></i>	<i>r<sub>a</sub></i> <sup>2)</sup>	<i>r<sub>b</sub></i> <sup>2)</sup>	<i>e</i>		<i>Y<sub>2</sub></i>	<i>Y<sub>3</sub></i>	<i>Y<sub>0</sub></i>					
mm	1/25.4	mm	1/25.4	mm	1/25.4	mm	1/25.4	min.	min.	max.	max.	min.	max.											
288.925	11.3750	406.400	16.0000	144.463	5.6875	144.463	5.6875	3.2	3.2	1 720	4 420	M255449TD/M255410	1	316	394	373	8	3.2	3.2	0.34	2.00	2.97	1.95	61.4
303.213	11.9375	495.300	19.5000	263.525	10.3750	263.525	10.3750	6.4	3.2	3 990	9 340	HH258249TD/HH258210	1-P	342	476	441	8	6.4	3.2	0.33	2.03	3.02	1.98	207
333.375	13.1250	469.900	18.5000	166.688	6.5625	166.688	6.5625	3.2	3.2	2 320	5 680	HM261049TD/HM261010	1-P	360	456	432	8	3.2	3.2	0.33	2.02	3.00	1.97	92.8
	13.1250	523.875	20.6250	185.738	7.3125	185.738	7.3125	6.4	3.2	2 730	6 780	HM265032TD/HM265010	1-P	403	500	483	7	6.4	3.2	0.33	2.03	3.02	1.98	138
344.091	13.5469	488.950	19.2500	184.150	7.2500	174.625	6.8750	3.2	3.2	2 310	5 800	HM262746TD/HM262710	1	376	475	450	8	3.2	3.2	0.33	2.02	3.00	1.97	108
346.075	13.6250	488.950	19.2500	174.625	6.8750	174.625	6.8750	3.2	3.2	2 310	5 800	HM262749TD/HM262710	1	378	475	450	8	3.2	3.2	0.33	2.02	3.00	1.97	105
368.300	14.5000	523.875	20.6250	185.738	7.3125	185.738	7.3125	6.4	3.2	2 730	6 780	HM265049TD/HM265010	1-P	403	500	483	7	6.4	3.2	0.33	2.03	3.02	1.98	110
384.175	15.1250	546.100	21.5000	193.675	7.6250	193.675	7.6250	6.4	3.2	3 260	8 430	HM266449TD/HM266410	1-P	418	525	505	10	6.4	3.2	0.33	2.03	3.02	1.98	155
406.400	16.0000	590.550	23.2500	209.550	8.2500	209.550	8.2500	6.4	3.2	3 390	8 930	M268743TD/M268710	1-P	456	570	545	9	6.4	3.2	0.33	2.03	3.02	1.98	199
415.925	16.3750	590.550	23.2500	209.550	8.2500	209.550	8.2500	6.4	3.2	3 390	8 930	M268749TD/M268710	1-P	456	570	545	9	6.4	3.2	0.33	2.03	3.02	1.98	189
447.675	17.6250	635.000	25.0000	223.838	8.8125	223.838	8.8125	6.4	3.2	3 930	10 500	M270749TD/M270710	1-P	491	610	585	8	6.4	3.2	0.33	2.03	3.02	1.98	234
479.425	18.8750	679.450	26.7500	238.125	9.3750	238.125	9.3750	6.4	3.2	4 240	11 100	M272749TD/M272710	1-P	520	655	630	7	6.4	3.2	0.33	2.03	3.02	1.98	277
501.650	19.7500	711.200	28.0000	250.825	9.8750	250.825	9.8750	6.4	3.2	4 810	12 800	M274149TD/M274110	1-P	545	690	655	10	6.4	3.2	0.33	2.03	3.02	1.98	323
519.113	20.4375	736.600	29.0000	258.763	10.1875	258.763	10.1875	6.4	3.2	5 290	13 600	M275349TD/M275310	1-P	560	710	680	10	6.4	3.2	0.33	2.03	3.02	1.98	361

[Notes] 1) While metric series bearings have minus tolerances for bore and OD, inch series have plus tolerances. Refer to page 190 for details of applicable tolerance standards.

2) *r<sub>a</sub>* indicates housing chamfer dimension corresponding to outer ring chamfer dimension *r*; *r<sub>b</sub>* indicates the shaft chamfer dimension corresponding to inner ring chamfer dimension *r<sub>1</sub>*.

# Double-row tapered roller bearings

TDO, TDOS type

*d* 100 ~ (120) mm

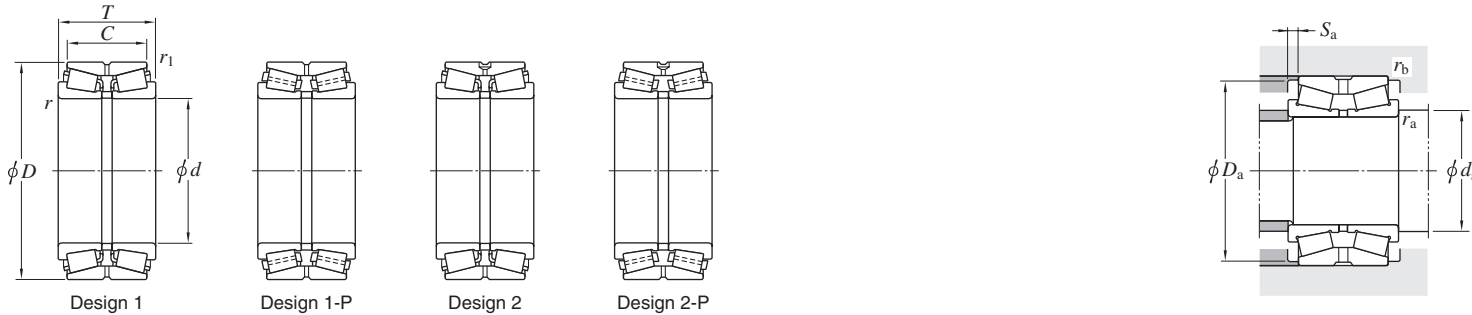

Boundary dimensions								Basic load ratings (kN)		Bearing No. <sup>1)</sup>	Design	Mounting dimensions (mm)					Constant <i>e</i>	Axial load factors			(Refer.) Mass (kg)
<i>d</i>	<i>D</i>		<i>T</i>		<i>C</i>		<i>r</i> <sup>2)</sup>	<i>r</i> <sub>1</sub> <sup>2)</sup>	<i>C</i> <sub>r</sub>			<i>C</i> <sub>0r</sub>	<i>d</i> <sub>a</sub>	<i>D</i> <sub>a</sub>	<i>S</i> <sub>a</sub>	<i>r</i> <sub>a</sub>		<i>r</i> <sub>b</sub> <sup>2)</sup>	<i>e</i>	<i>Y</i> <sub>2</sub>	
mm	mm		mm		mm		min.	min.			min.	min.	min.	max.	max.						
100	—	150	—	46	—	37	—	2	0.6	180	293	46220A			—	—	—	—	—	2.53	
	—	165	—	52	—	46	—	2.5	0.6	198	305	46320			—	—	—	—	—	4.03	
	—	165	—	65	—	52	—	2.5	0.6	265	443	46320A			—	—	—	—	—	4.97	
	—	180	—	83	—	67	—	2.5	1	443	676	46T30220JR/67			—	—	—	—	—	8.33	
	—	180	—	107	—	87	—	2.5	1	596	990	46T32220JR/87			—	—	—	—	—	11.1	
	—	200	—	116	—	80	—	4	SP	594	941	46T202012			—	—	—	—	—	15	
100.000	3.9370	304.800	12.0000	184.160	7.2504	127.000	5.0000	SP	SP	1 190	1 630	46T203018			—	—	—	—	—	70.0	
105.000	4.1339	190.000	7.4803	88.000	3.4646	70.000	2.7559	SP	SP	423	632	46T211909			—	—	—	—	—	9.68	
105	—	190	—	88	—	70	—	2.5	1	494	761	46T30221JR/70			—	—	—	—	—	9.87	
	—	190	—	115	—	95	—	2.5	1	672	1 130	46T32221JR/95			—	—	—	—	—	13.5	
110	—	170	—	45	—	40	—	2.5	0.6	175	304	46222			—	—	—	—	—	3.58	
	—	180	—	56	—	50	—	2.5	0.6	245	388	46322			—	—	—	—	—	5.13	
	—	180	—	70	—	56	—	2.5	0.6	324	533	46322A			—	—	—	—	—	6.43	
	—	180	—	94	—	72	—	2	0.6	401	761	46T221810			—	—	—	—	—	8.82	
	—	180	—	125	—	100	—	2.5	0.6	538	1 070	46T221813-1			—	—	—	—	—	11.6	
	—	200	—	92	—	74	—	2.5	1	556	868	46T30222JR/74			—	—	—	—	—	11.6	
	—	200	—	121	—	101	—	2.5	1	750	1 280	46T32222JR/101			—	—	—	—	—	15.9	
	—	220	—	145	—	115	—	3	1	902	1 430	46T222215			—	—	—	—	—	23.8	
115	—	190	—	106	—	80	—	4	1.5	520	965	46T231911			—	—	—	—	—	10.7	
	—	230	—	116	—	84	—	3	SP	631	1 060	46T232312			—	—	—	—	—	20.9	
120	—	180	—	46	—	41	—	2.5	0.6	185	317	46224			—	—	—	—	—	3.81	
	—	180	—	58	—	46	—	2.5	0.6	247	460	46224A			—	—	—	—	—	4.66	
	—	200	—	62	—	55	—	2.5	0.6	292	470	46324			—	—	—	—	—	7.28	
	—	200	—	78	—	62	—	2.5	0.6	387	672	46324A			—	—	—	—	—	9.14	
	—	200	—	100	—	84	—	2.5	0.6	533	1 010	46324AS			—	—	—	—	—	12.0	

[Notes] 1) While metric series bearings have minus tolerances for bore and OD, inch series have plus tolerances. Refer to page 190 for details of applicable tolerance standards.

2) SP indicates the specially chamfered form.

# Double-row tapered roller bearings

## TDO, TDOS type

d (120) ~ (130) mm

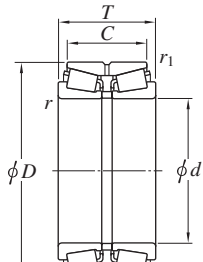

Design 1

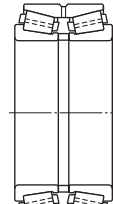

Design 1-P



Design 2



Design 2-P

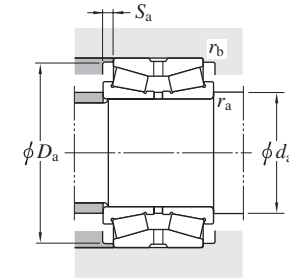

Boundary dimensions								Basic load ratings (kN)		Bearing No. <sup>1)</sup>	Design	Mounting dimensions (mm)					Constant e	Axial load factors			(Refer.) Mass (kg)
d	D		T		C		r <sup>2)</sup>	r <sup>1 2)</sup>	C <sub>r</sub>			C <sub>0r</sub>	d <sub>a</sub>	D <sub>a</sub>	S <sub>a</sub>	r <sub>a</sub>		r <sub>b</sub> <sup>2)</sup>	Y <sub>2</sub>	Y <sub>3</sub>	
mm	1/25.4	mm	1/25.4	mm	1/25.4	mm	1/25.4	min.	min.			min.	min.	min.	max.	max.					
<b>120</b>	—	215	—	97	—	78	—	2.5	1	595	945	<b>46T30224JR/78</b>					0.44	1.55	2.31	1.52	13.9
	—	215	—	132	—	109	—	2.5	1	806	1 380	<b>46T32224JR/109</b>									
<b>125</b>	—	180	—	85	—	75	—	3	0.6	389	858	<b>46T251809</b>					0.31	2.21	3.29	2.16	6.8
	—	230	—	116	—	84	—	4	SP	631	1 060	<b>46T252312</b>					0.73	0.92	1.37	0.90	19.5
	—	235	—	142	—	114	—	SP	SP	897	1 650	<b>46T252414</b>					0.37	1.83	2.72	1.79	26.2
	—	235	—	145	—	115	—	4	1.5	897	1 650	<b>46T252415</b>					0.37	1.83	2.72	1.79	26.4
<b>127.000</b>	5.0000	169.975	6.6919	58.738	2.3125	49.213	1.9375	1.6	1	225	501	<b>L225849/L225812D</b>					0.33	2.03	3.02	1.98	3.45
	5.0000	182.563	7.1875	85.725	3.3750	73.025	2.8750	3.6	0.8	389	858	<b>48290/48220D</b>					0.31	2.21	3.29	2.16	6.95
	5.0000	196.850	7.7500	101.600	4.0000	85.725	3.3750	3.6	0.8	534	1 120	<b>67388/67322D</b>					0.34	1.96	2.92	1.92	10.9
	5.0000	200.025	7.8750	101.600	4.0000	85.725	3.3750	3.6	0.8	534	1 120	<b>67388/67325D</b>					0.34	1.96	2.92	1.92	11.6
	5.0000	215.900	8.5000	106.363	4.1875	80.963	3.1875	3.6	1.6	551	1 100	<b>74500/74851D</b>					0.49	1.38	2.06	1.35	15.0
	5.0000	228.600	9.0000	115.888	4.5625	84.138	3.3125	3.6	2.4	558	918	<b>97500/97901D</b>					0.74	0.92	1.36	0.90	17.8
	5.0000	228.600	9.0000	115.888	4.5625	84.138	3.3125	3.6	2.4	737	1 300	<b>HM926747/HM926710D</b>					0.74	0.92	1.36	0.90	19.6
	5.0000	234.950	9.2500	142.875	5.6250	114.300	4.5000	6.4	1.6	897	1 650	<b>95500/95927D</b>					0.37	1.83	2.72	1.79	25.8
<b>127.792</b>	5.0312	228.600	9.0000	115.888	4.5625	84.138	3.3125	3.6	2.4	737	1 300	<b>HM926749/HM926710D</b>					0.74	0.92	1.36	0.90	19.5
<b>128.588</b>	5.0625	206.375	8.1250	107.950	4.2500	82.550	3.2500	3.2	0.8	558	1 100	<b>799/792D</b>					0.46	1.47	2.19	1.44	12.9
<b>130</b>	—	180	—	69	—	55	—	2	0.6	322	663	<b>46T261807</b>					0.33	2.03	3.02	1.98	4.77
	—	200	—	52	—	46	—	2.5	0.6	239	425	<b>46226</b>					0.35	1.95	2.90	1.91	5.57
	—	200	—	65	—	52	—	2.5	0.6	319	618	<b>46226A</b>					0.35	1.95	2.90	1.91	7.06
<b>130.000</b>	5.1181	206.375	8.1250	107.950	4.2500	82.550	3.2500	3.6	0.8	558	1 100	<b>797/792D</b>					0.46	1.47	2.19	1.44	12.7
<b>130</b>	—	210	—	64	—	57	—	2.5	0.6	322	535	<b>46326</b>					0.36	1.87	2.79	1.83	7.81
	—	210	—	80	—	64	—	2.5	0.6	424	723	<b>46326A</b>					0.36	1.87	2.79	1.83	9.57
	—	210	—	109	—	90	—	2.5	0.6	647	1 190	<b>46T262111</b>					0.26	2.55	3.80	2.50	13.4
	—	214	—	115	—	98	—	2.5	1	667	1 220	<b>46T262112</b>					0.33	2.03	3.02	1.98	15
	—	230	—	98	—	78.5	—	3	1	646	1 020	<b>46T30226JR/78.5</b>					0.44	1.55	2.31	1.52	15.7

[Notes] 1) While metric series bearings have minus tolerances for bore and OD, inch series have plus tolerances. Refer to page 190 for details of applicable tolerance standards.

2) SP indicates the specially chamfered form.



# Double-row tapered roller bearings

## TDO, TDOS type

*d* (130) ~ (140) mm

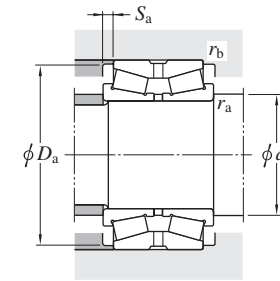
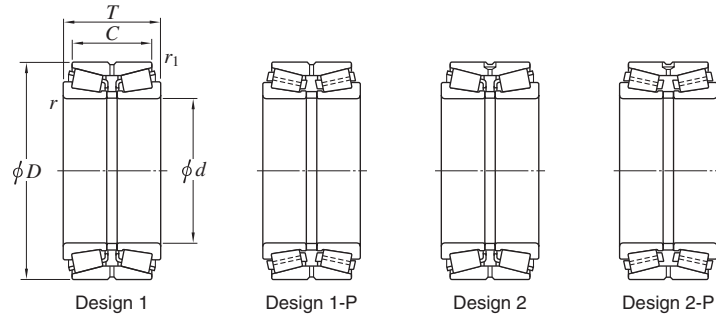

Boundary dimensions								Basic load ratings (kN)		Bearing No. <sup>1)</sup>	Design	Mounting dimensions (mm)					Constant <i>e</i>	Axial load factors			(Refer.) Mass (kg)		
<i>d</i> mm	<i>D</i> mm	<i>T</i> mm	<i>C</i> mm	<i>r</i> min.	<i>r</i> <sub>1</sub> min.	<i>C</i> <sub>r</sub>	<i>C</i> <sub>0r</sub>	<i>d</i> <sub>a</sub> min.	<i>D</i> <sub>a</sub> min.			<i>S</i> <sub>a</sub> min.	<i>r</i> <sub>a</sub> max.	<i>r</i> <sub>b</sub> max.	<i>Y</i> <sub>2</sub>	<i>Y</i> <sub>3</sub>		<i>Y</i> <sub>0</sub>					
130	—	230	—	149	—	120	—	4	1	928	1 650	<b>46T262315A</b>	1	148	222	14.5	3	1	0.43	1.57	2.34	1.53	24.2
	—	280	—	137	—	107.5	—	4	1.5	1 130	1 670	<b>46T30326JR/107.5</b>	1	152	255	15	4	1.5	0.35	1.96	2.91	1.91	38.1
130.175	5.1250	196.850	7.7500	101.600	4.0000	85.725	3.3750	3.6	0.8	534	1 120	<b>67389/67322D</b>	1	143	189	7.9	3.6	0.8	0.34	1.96	2.92	1.92	10.4
	5.1250	206.375	8.1250	107.950	4.2500	82.550	3.2500	3.6	0.8	558	1 100	<b>799A/792D</b>	1	143	195	12.7	3.6	0.8	0.46	1.47	2.19	1.44	12.6
133	—	216	—	106	—	81	—	3	1	551	1 100	<b>46T2622</b>	1	147	205	12.5	2.5	1	0.49	1.38	2.06	1.35	14.1
133.350	5.2500	177.008	6.9688	57.150	2.2500	47.625	1.8750	1.6	0.8	241	557	<b>L327249/L327210D</b>	1	142	169	4.8	1.6	0.8	0.35	1.94	2.89	1.90	3.63
	5.2500	190.500	7.5000	85.725	3.3750	73.025	2.8750	3.6	0.8	405	944	<b>48385/48320D</b>	1	146	182	6.4	3.6	0.8	0.32	2.10	3.13	2.06	7.63
	5.2500	196.850	7.7500	101.600	4.0000	85.725	3.3750	3.6	0.8	534	1 120	<b>67390/67322D</b>	1	146	189	7.9	3.6	0.8	0.34	1.96	2.92	1.92	9.88
	5.2500	196.850	7.7500	101.600	4.0000	85.725	3.3750	7.9	0.8	534	1 120	<b>67391/67322D</b>	1	155	189	7.9	7.9	0.8	0.34	1.96	2.92	1.92	9.81
	5.2500	200.025	7.8750	101.600	4.0000	85.725	3.3750	3.6	0.8	534	1 120	<b>67390/67325D</b>	1	146	189	7.9	3.6	0.8	0.34	1.96	2.92	1.92	10.5
	5.2500	215.900	8.5000	106.363	4.1875	80.963	3.1875	3.6	1.6	551	1 100	<b>74525/74851D</b>	1	146	205	12.7	3.6	1.6	0.49	1.38	2.06	1.35	13.9
	5.2500	234.950	9.2500	142.875	5.6250	114.300	4.5000	9.5	1.6	897	1 650	<b>95525/95927D</b>	1	158	217	14.3	9.5	1.6	0.37	1.83	2.72	1.79	24.3
	5.2500	234.950	9.2500	142.875	5.6250	114.300	4.5000	4.7	1.6	897	1 650	<b>95528/95927D</b>	1	148	217	14.3	4.7	1.6	0.37	1.83	2.72	1.79	24.4
136.525	5.3750	190.500	7.5000	85.725	3.3750	73.025	2.8750	3.6	0.8	405	944	<b>48393/48320D</b>	1	149	182	6.4	3.6	0.8	0.32	2.10	3.13	2.06	7.18
	5.3750	215.900	8.5000	106.363	4.1875	80.963	3.1875	3.6	1.6	551	1 100	<b>74537/74851D</b>	1	149	205	12.7	3.6	1.6	0.49	1.38	2.06	1.35	13.4
	5.3750	228.600	9.0000	123.825	4.8750	98.425	3.8750	3.6	1.6	753	1 460	<b>896/892D</b>	1	149	215	12.7	3.6	1.6	0.42	1.60	2.39	1.57	19.2
139.700	5.5000	215.900	8.5000	106.363	4.1875	80.963	3.1875	3.6	1.6	551	1 100	<b>74550/74851D</b>	1	152	205	12.7	3.6	1.6	0.49	1.38	2.06	1.35	12.8
	5.5000	215.900	8.5000	106.363	4.1875	80.963	3.1875	6.4	1.6	551	1 100	<b>74550A/74851D</b>	1	158	205	12.7	6.4	1.6	0.49	1.38	2.06	1.35	12.8
	5.5000	228.600	9.0000	123.825	4.8750	98.425	3.8750	3.6	1.6	753	1 460	<b>898/892D</b>	1	152	215	12.7	3.6	1.6	0.42	1.60	2.39	1.57	18.5
	5.5000	228.600	9.0000	123.825	4.8750	98.425	3.8750	6.4	1.6	753	1 460	<b>898A/892D</b>	1	158	215	12.7	6.4	1.6	0.42	1.60	2.39	1.57	18.5
	5.5000	236.538	9.3125	131.763	5.1875	106.363	4.1875	3.6	1.6	719	1 460	<b>82550/82932D</b>	1	152	225	12.7	3.6	1.6	0.44	1.53	2.27	1.49	22.6
	5.5000	236.538	9.3125	131.763	5.1875	106.363	4.1875	3.6	1.6	856	1 660	<b>HM231132/HM231111D</b>	1	152	223	12.7	3.6	1.6	0.32	2.12	3.15	2.07	22.5
	5.5000	254.000	10.0000	149.225	5.8750	111.125	4.3750	7.1	1.6	941	1 830	<b>99550/99102D</b>	1	159	237	19.1	7.1	1.6	0.41	1.66	2.47	1.62	31.1
	5.5000	307.975	12.1250	200.025	7.8750	155.575	6.1250	9.5	2.4	1 740	2 900	<b>HH234031/HH234011D</b>	1	164	285	22.2	9.5	2.4	0.33	2.07	3.08	2.02	68.3
140	—	210	—	53	—	47	—	2.5	0.6	239	404	<b>46228</b>	1	152	196	3	2	0.6	0.33	2.03	3.02	1.98	5.85

[Note] 1) While metric series bearings have minus tolerances for bore and OD, inch series have plus tolerances. Refer to page 190 for details of applicable tolerance standards.

## Double-row tapered roller bearings

**TDO, TDOS type**  
**d (140) ~ (150) mm**

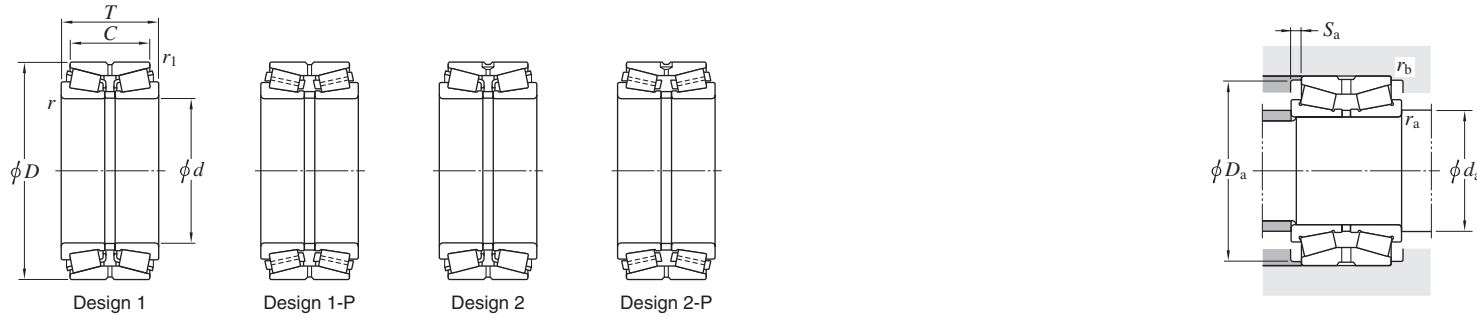

Boundary dimensions								Basic load ratings (kN)		Bearing No. <sup>1)</sup>	Design	Mounting dimensions (mm)					Constant <i>e</i>	Axial load factors			(Refer.) Mass (kg)		
<i>d</i> mm	<i>D</i> mm 1/25.4		<i>T</i> mm 1/25.4		<i>C</i> mm 1/25.4		<i>r</i> min.	<i>r</i> <sub>1</sub> min.	<i>C<sub>r</sub></i>			<i>C<sub>0r</sub></i>	<i>d<sub>a</sub></i> min.	<i>D<sub>a</sub></i> min.	<i>S<sub>a</sub></i> min.	<i>r<sub>a</sub></i> max.		<i>r<sub>b</sub></i> max.	<i>e</i>	<i>Y</i> <sub>2</sub>		<i>Y</i> <sub>3</sub>	<i>Y</i> <sub>0</sub>
<b>140</b>	—	210	—	66	—	53	—	2.5	0.6	360	639	<b>46228A</b>	1	152	199	6.5	2	0.6	0.47	1.43	2.12	1.40	7.18
	—	225	—	68	—	61	—	3	1	360	564	<b>46328</b>	1	154	210	3.5	2.5	1	0.35	1.95	2.90	1.91	9.56
	—	225	—	85	—	68	—	3	1	475	836	<b>46328A</b>	1	154	212	8	2.5	1	0.35	1.95	2.90	1.91	11.8
	—	230	—	120	—	94	—	4	1	688	1 360	<b>46T282312</b>	1	158	212	13	3	1	0.42	1.60	2.38	1.56	18.7
	—	230	—	140	—	110	—	3	1	804	1 480	<b>46T282314</b>	1	154	218	15	2.5	1	0.35	1.95	2.90	1.91	20.3
	—	240	—	132	—	106	—	4	1.5	719	1 460	<b>46T282413</b>	1	158	225	13	3	1.5	0.44	1.53	2.27	1.49	23.6
	—	250	—	153	—	125.5	—	3	1	1 090	1 920	<b>46T32228JR/125.5</b>	1	158	238	14	3	1	0.44	1.55	2.31	1.52	30.2
	—	270	—	170	—	125	—	4	1	1 210	2 130	<b>46T282717</b>	1	158	253	22.5	3	1	0.44	1.55	2.31	1.52	41.5
	<b>142.875</b>	5.6250	200.025	7.8750	87.315	3.4376	73.025	2.8750	7.9	0.8	422	982	<b>48684/48620D</b>	1	164	191	7.1	7.9	0.8	0.34	2.01	2.99	1.96
5.6250		200.025	7.8750	87.315	3.4376	73.025	2.8750	3.6	0.8	422	982	<b>48685/48620D</b>	1	156	191	7.1	3.6	0.8	0.34	2.01	2.99	1.96	8.06
5.6250		236.538	9.3125	131.763	5.1875	106.363	4.1875	3.6	1.6	719	1 460	<b>82562/82932D</b>	1	156	225	12.7	3.6	1.6	0.44	1.53	2.27	1.49	21.9
<b>146.050</b>	5.7500	193.675	7.6250	65.085	2.5624	53.975	2.1250	1.6	0.8	321	750	<b>36690/36620D</b>	1	155	186	5.6	1.6	0.8	0.37	1.83	2.73	1.79	4.96
	5.7500	193.675	7.6250	65.085	2.5624	53.975	2.1250	4.8	0.8	321	750	<b>36691/36620D</b>	1	161	186	5.6	4.8	0.8	0.37	1.83	2.73	1.79	4.93
	5.7500	236.538	9.3125	131.763	5.1875	106.363	4.1875	3.6	1.6	719	1 460	<b>82576/82932D</b>	1	159	225	12.7	3.6	1.6	0.44	1.53	2.27	1.49	21.1
	5.7500	236.538	9.3125	131.763	5.1875	106.363	4.1875	3.6	1.6	856	1 660	<b>HM231140/HM231111D</b>	1	159	223	12.7	3.6	1.6	0.32	2.12	3.15	2.07	21.0
	5.7500	254.000	10.0000	149.225	5.8750	111.125	4.3750	7.1	1.6	941	1 830	<b>99575/99102D</b>	1	166	237	19.1	7.1	1.6	0.41	1.66	2.47	1.62	29.4
	5.7500	268.288	10.5625	160.338	6.3125	125.413	4.9375	6.4	1.6	1 130	2 090	<b>EE107057/107105D</b>	1	164	249	17.5	6.4	1.6	0.39	1.74	2.59	1.70	38.1
	5.7500	304.800	12.0000	135.733	5.3438	97.633	3.8438	3.2	1.6	1 030	1 600	<b>EE750576/751204D</b>	1-P	158	268	19.1	3.2	1.6	0.33	2.03	3.02	1.98	43.2
<b>149.225</b>	5.8750	236.538	9.3125	131.763	5.1875	106.363	4.1875	3.6	1.6	719	1 460	<b>82587/82932D</b>	1	162	225	12.7	3.6	1.6	0.44	1.53	2.27	1.49	20.4
	5.8750	236.538	9.3125	131.763	5.1875	106.363	4.1875	6.4	1.6	856	1 660	<b>HM231148/HM231111D</b>	1	167	223	12.7	6.4	1.6	0.32	2.12	3.15	2.07	20.2
	5.8750	236.538	9.3125	131.763	5.1875	106.363	4.1875	3.6	1.6	856	1 660	<b>HM231149/HM231111D</b>	1	162	223	12.7	3.6	1.6	0.32	2.12	3.15	2.07	20.3
<b>150</b>	—	225	—	56	—	50	—	3	1	278	476	<b>46230</b>	1	164	213	3	2.5	1	0.33	2.03	3.02	1.98	7.09
	—	225	—	70	—	56	—	3	1	377	703	<b>46230A</b>	1	164	213	7	2.5	1	0.33	2.03	3.02	1.98	8.82
	—	245	—	108	—	80	—	4	1.5	552	989	<b>46T302511</b>	1	168	227	14	3	1.5	0.35	1.93	2.88	1.89	17.2
	—	250	—	80	—	71	—	3	1	467	786	<b>46330</b>	1	164	233	4.5	2.5	1	0.35	1.95	2.90	1.91	14.6
	—	250	—	100	—	80	—	3	1	595	1 070	<b>46330A</b>	1	164	234	10	2.5	1	0.35	1.95	2.90	1.91	17.6
	—	250	—	137	—	112	—	3	1	816	1 510	<b>46T302514A</b>	1	164	238	12.5	2.5	1	0.41	1.66	2.47	1.62	24.3

[Note] 1) While metric series bearings have minus tolerances for bore and OD, inch series have plus tolerances. Refer to page 190 for details of applicable tolerance standards.

# Double-row tapered roller bearings

## TDO, TDOS type

$d$  (150) ~ 160.325 mm

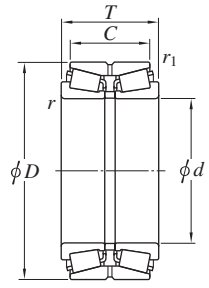

Design 1



Design 1-P

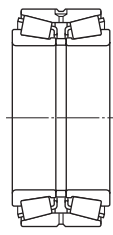

Design 2



Design 2-P

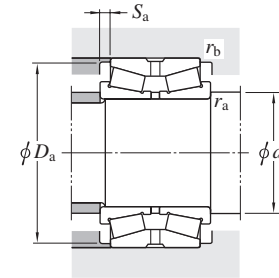

$d$ mm	Boundary dimensions				$r$ $r_1^{2)}$ min. min.		Basic load ratings (kN)		Bearing No. <sup>1)</sup>	Design	Mounting dimensions (mm)					Constant $e$	Axial load factors			(Refer.) Mass (kg)			
	$D$ mm	$T$ mm	$C$ mm	$r_1$ mm			$C_r$	$C_{Or}$			$d_a$ min.	$D_a$ min.	$S_a$ min.	$r_a$ max.	$r_b^{2)}$ max.		$Y_2$	$Y_3$	$Y_0$				
150	—	250	—	140	—	115	—	3	SP	816	1 510	46T302514B	1	164	239	12	2.5	SP	0.41	1.66	2.47	1.62	28.0
	—	250	—	142	—	112	—	3	SP	816	1 510	46T302514	1	164	237	15	2.5	SP	0.41	1.66	2.47	1.62	25.1
	—	250	—	145	—	115	—	4	1.5	816	1 510	46T302515	1	168	239	15	3	1.5	0.41	1.66	2.47	1.62	25.7
	—	260	—	150	—	115	—	4	1.5	944	1 740	46T302615	1	168	246	17.5	3	1.5	0.43	1.57	2.34	1.53	30.4
	—	270	—	109	—	87	—	3	1	827	1 330	46T30230JR/87	1	168	255	11	3	1	0.44	1.55	2.31	1.52	24.6
	—	270	—	164	—	130	—	3	1	1 210	2 130	46T32230JR/130	1	168	254	17	3	1	0.44	1.55	2.31	1.52	38
	—	280	—	160	—	104	—	4	1	1 030	1 730	46T302816	1	168	265	28	3	1	0.81	0.83	1.23	0.81	38.7
150.813	5.9375	244.475	9.6250	107.950	4.2500	79.375	3.1250	3.6	1.6	552	989	81593/81963D	1	163	227	14.3	3.6	1.6	0.35	1.93	2.88	1.89	16.7
152.400	6.0000	222.250	8.7500	100.010	3.9374	76.200	3.0000	3.6	0.8	541	1 190	M231649/M231610D	1	165	210	11.9	3.6	0.8	0.33	2.03	3.02	1.98	11.9
	6.0000	244.475	9.6250	107.950	4.2500	79.375	3.1250	3.6	1.6	552	989	81600/81963D	1	165	227	14.3	3.6	1.6	0.35	1.93	2.88	1.89	16.4
	6.0000	254.000	10.0000	149.225	5.8750	111.125	4.3750	7.1	1.6	941	1 830	99600/99102D	1	172	237	19.1	7.1	1.6	0.41	1.66	2.47	1.62	27.7
	6.0000	268.288	10.5625	160.338	6.3125	125.413	4.9375	6.4	1.6	1 130	2 090	EE107060/107105D	1	171	249	17.5	6.4	1.6	0.39	1.74	2.59	1.70	36.2
	6.0000	307.975	12.1250	200.025	7.8750	146.050	5.7500	9.5	2.4	1 360	2 300	EE450601/451215D	1	177	275	27	9.5	2.4	0.33	2.07	3.09	2.03	61.6
	6.0000	307.975	12.1250	200.025	7.8750	155.575	6.1250	9.5	2.4	1 740	2 900	HH234048/HH234011D	1	177	285	22.2	9.5	2.4	0.33	2.07	3.08	2.02	63.7
155	—	330	—	180	—	120	—	6	1.5	1 490	2 410	46T313318A	1	183	315	30	5	1.5	0.81	0.83	1.24	0.82	70.0
158.750	6.2500	225.425	8.8750	85.725	3.3750	69.850	2.7500	3.6	0.8	442	1 140	46780R/46720D	1	171	215	7.9	3.6	0.8	0.38	1.76	2.62	1.72	10.7
160	—	240	—	60	—	53	—	3	1	324	565	46232	1	174	228	3.5	2.5	1	0.33	2.03	3.02	1.98	8.71
	—	240	—	75	—	60	—	3	1	406	756	46232A	1	174	226	7.5	2.5	1	0.33	2.03	3.02	1.98	10.6
	—	270	—	86	—	76	—	3	1	592	950	46332	1	174	252	5	2.5	1	0.35	1.95	2.90	1.91	18.8
	—	270	—	108	—	86	—	3	1	727	1 270	46332A	1	174	252	11	2.5	1	0.35	1.95	2.90	1.91	23.1
	—	270	—	149	—	120	—	3	1	1 040	1 970	46T322715	1	174	257	14.5	2.5	1	0.40	1.70	2.53	1.66	32.4
	—	280	—	150	—	125	—	4	1	1 090	2 000	46T322815	1	178	262	12.5	3	1	0.32	2.12	3.15	2.07	36.2
	—	290	—	178	—	144	—	3	1	1 360	2 420	46T32232JR/144	1	178	274	17	3	1	0.44	1.55	2.31	1.52	47.6
160.325	6.3120	288.925	11.3750	142.875	5.6250	111.125	4.3750	7.1	1.6	1 080	1 950	HM237532/HM237510D	1	180	271	15.9	7.1	1.6	0.32	2.12	3.15	2.07	37.2

[Notes] 1) While metric series bearings have minus tolerances for bore and OD, inch series have plus tolerances. Refer to page 190 for details of applicable tolerance standards.

2) SP indicates the specially chamfered form.

# Double-row tapered roller bearings

TDO, TDOS type

d 165 ~ 175 mm

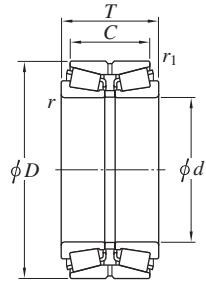

Design 1



Design 1-P



Design 2



Design 2-P

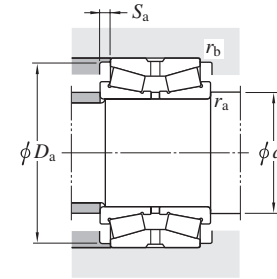

Boundary dimensions						Basic load ratings (kN)				Bearing No. <sup>1)</sup>	Design	Mounting dimensions (mm)					Constant e	Axial load factors			(Refer.) Mass (kg)
d	D	T	C	r <sup>2)</sup>	r <sub>1</sub> <sup>2)</sup>	C <sub>r</sub>	C <sub>0r</sub>	d <sub>a</sub>	D <sub>a</sub>			S <sub>a</sub>	r <sub>a</sub>	r <sub>b</sub>	Y <sub>2</sub>	Y <sub>3</sub>		Y <sub>0</sub>			
mm	mm	mm	mm	mm	mm	mm	mm	mm	mm	mm	mm	mm	mm	mm	mm	mm	mm				
165	—	290	—	143	—	113	—	SP	1.5	1 080	1 950	<b>46T332914</b>					0.32	2.12	3.15	2.07	40.0
	—	290	—	150	—	125	—	6	1	1 170	2 140	<b>46T332915</b>					0.32	2.12	3.15	2.07	40.1
165.100	6.5000	215.900	8.5000	58.740	2.3126	47.625	1.8750	1.6	0.8	264	600	<b>L433749/L433710D</b>					0.36	1.85	2.76	1.81	5.06
	6.5000	225.425	8.8750	85.725	3.3750	69.850	2.7500	3.6	0.8	442	1 140	<b>46790R/46720D</b>					0.38	1.76	2.62	1.72	9.64
	6.5000	247.650	9.7500	103.188	4.0625	84.138	3.3125	3.6	0.8	593	1 400	<b>67780/67720D</b>					0.44	1.54	2.29	1.50	16.9
	6.5000	254.000	10.0000	101.600	4.0000	76.200	3.0000	4.8	1.6	649	1 240	<b>M235145/M235113D</b>					0.32	2.12	3.15	2.07	17.0
	6.5000	288.925	11.3750	142.875	5.6250	111.125	4.3750	7.1	1.6	943	1 920	<b>94649/94114D</b>					0.47	1.44	2.15	1.41	37.7
	6.5000	288.925	11.3750	142.875	5.6250	111.125	4.3750	7.1	1.6	1 140	2 090	<b>HM237535/HM237510D</b>					0.32	2.12	3.15	2.07	35.9
	6.5000	288.925	11.3750	146.050	5.7500	114.300	4.5000	7.1	1.6	1 140	2 090	<b>HM237535/HM237511XD</b>					0.32	2.12	3.15	2.07	36.5
168.275	6.6250	247.650	9.7500	103.188	4.0625	84.138	3.3125	3.6	0.8	593	1 400	<b>67782/67720D</b>					0.44	1.54	2.29	1.50	16.3
	6.6250	250.000	9.8425	103.190	4.0626	84.140	3.3126	SP	SP	701	1 410	<b>46T342510</b>					0.33	2.03	3.02	1.98	16.1
	6.6250	360.000	14.1732	190.000	7.4803	130.000	5.1181	SP	SP	1 610	2 570	<b>46T343619</b>					0.80	0.85	1.26	0.83	83.9
170.000	6.6929	254.000	10.0000	101.600	4.0000	76.200	3.0000	4.8	1.6	649	1 240	<b>M235149/M235113D</b>					0.32	2.12	3.15	2.07	16.0
170	—	260	—	67	—	60	—	3	1	382	642	<b>46234</b>					0.33	2.03	3.02	1.98	11.4
	—	260	—	84	—	67	—	3	1	502	969	<b>46234A</b>					0.33	2.03	3.02	1.98	14.7
	—	280	—	88	—	78	—	3	1	599	1 050	<b>46334</b>					0.33	2.06	3.06	2.01	19.8
	—	280	—	110	—	88	—	3	1	776	1 390	<b>46334A</b>					0.33	2.06	3.06	2.01	24.7
	—	310	—	195	—	150	—	5	1.5	1 610	2 790	<b>46T343120-1</b>					0.33	2.03	3.02	1.98	58.1
171.450	6.7500	288.925	11.3750	142.875	5.6250	111.125	4.3750	7.1	1.6	943	1 920	<b>94675/94114D</b>					0.47	1.44	2.15	1.41	35.9
174.625	6.8750	247.650	9.7500	103.188	4.0625	84.138	3.3125	7.9	0.8	593	1 400	<b>67786/67720D</b>					0.44	1.54	2.29	1.50	14.8
	6.8750	247.650	9.7500	103.188	4.0625	84.138	3.3125	3.6	0.8	593	1 400	<b>67787/67720D</b>					0.44	1.54	2.29	1.50	14.9
	6.8750	288.925	11.3750	142.875	5.6250	111.125	4.3750	7.1	1.6	943	1 920	<b>94687/94114D</b>					0.47	1.44	2.15	1.41	34.9
	6.8750	288.925	11.3750	142.875	5.6250	111.125	4.3750	7.1	1.6	1 080	1 950	<b>HM237542/HM237510D</b>					0.32	2.12	3.15	2.07	33.1
175	—	320	—	180	—	140	—	5	1.5	1 460	2 530	<b>46T3532</b>					0.32	2.12	3.15	2.07	56.7

[Notes] 1) While metric series bearings have minus tolerances for bore and OD, inch series have plus tolerances. Refer to page 190 for details of applicable tolerance standards.

2) SP indicates the specially chamfered form.

## Double-row tapered roller bearings

### TDO, TDOS type

$d$  177.800 ~ (187.325) mm

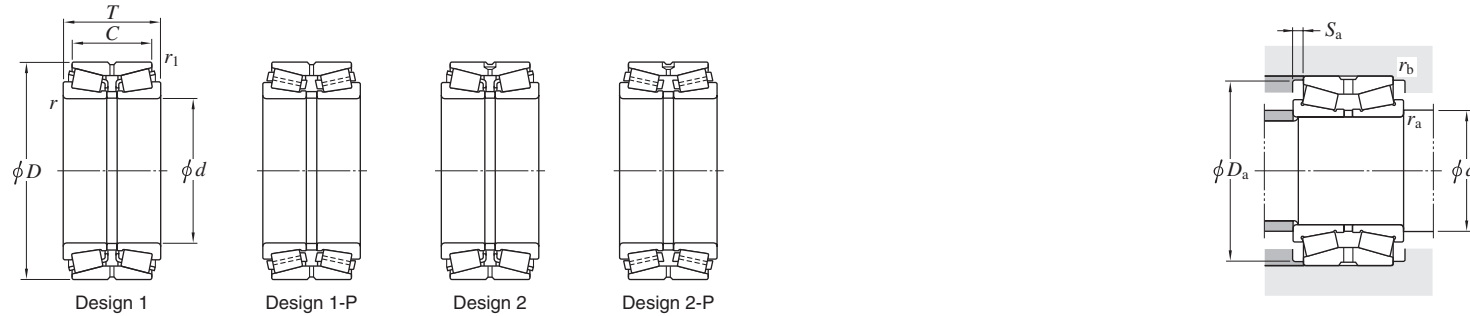

Boundary dimensions								Basic load ratings (kN)		Bearing No. 1)	Design <sup>3)</sup>	Mounting dimensions (mm)					Constant $e$	Axial load factors			(Refer.) Mass (kg)		
$d$	$D$	$T$	$C$	$r^{2)}$	$r_1^{2)}$	$C_r$	$C_{Or}$	$d_a$	$D_a$			$S_a$	$r_a$	$r_b^{2)}$	$e$	$Y_2$		$Y_3$	$Y_0$				
mm	mm	mm	mm	mm	mm	min.	min.	min.	min.	min.	max.	max.											
177.800	7.0000	227.013	8.9375	66.672	2.6249	52.388	2.0625	1.6	0.8	304	805	<b>36990/36920D</b>	1	186	220	7.1	1.6	0.8	0.44	1.53	2.28	1.50	6.18
	7.0000	247.650	9.7500	103.188	4.0625	84.138	3.3125	3.6	0.8	593	1 400	<b>67790/67720D</b>	1	190	238	9.5	3.6	0.8	0.44	1.54	2.29	1.50	14.2
	7.0000	247.650	9.7500	103.188	4.0625	84.138	3.3125	10.4	0.8	593	1 400	<b>67791/67720D</b>	1	204	238	9.5	10.4	0.8	0.44	1.54	2.29	1.50	14.0
	7.0000	269.875	10.6250	119.063	4.6875	93.663	3.6875	3.6	1.6	704	1 610	<b>M238840/M238810D</b>	1	190	255	12.7	3.6	1.6	0.33	2.03	3.02	1.98	23.0
	7.0000	285.750	11.2500	136.525	5.3750	92.075	3.6250	6.4	1.6	760	1 430	<b>EE91702/91113XD</b>	1*	196	264	22.2	6.4	1.6	0.43	1.57	2.34	1.53	28.5
	7.0000	288.925	11.3750	142.875	5.6250	111.125	4.3750	7.1	1.6	943	1 920	<b>94700/94114D</b>	1	197	270	15.9	7.1	1.6	0.47	1.44	2.15	1.41	33.9
	7.0000	288.925	11.3750	142.875	5.6250	111.125	4.3750	7.1	1.6	1 080	1 950	<b>HM237545/HM237510D</b>	1	197	271	15.9	7.1	1.6	0.32	2.12	3.15	2.07	32.1
	7.0000	288.925	11.3750	146.050	5.7500	114.300	4.5000	7.1	1.6	1 080	1 950	<b>HM237545/HM237511XD</b>	1*	197	271	15.9	7.1	1.6	0.32	2.12	3.15	2.07	32.7
	7.0000	304.800	12.0000	147.838	5.8204	98.425	3.8750	6.4	1.6	939	1 600	<b>EE280702/281201D</b>	1	196	282	24.7	6.4	1.6	0.36	1.87	2.79	1.83	37.2
	7.0000	320.675	12.6250	185.738	7.3125	138.112	5.4375	3.6	1.6	1 280	2 450	<b>EE222070/222127D</b>	1	190	298	23.8	3.6	1.6	0.40	1.68	2.50	1.64	59.0
7.0000	320.675	12.6250	185.738	7.3125	138.113	5.4375	3.6	1.6	1 460	2 530	<b>H239640/H239612D</b>	1	190	301	23.8	3.6	1.6	0.32	2.12	3.15	2.07	56.6	
179.975	7.0856	317.500	12.5000	146.050	5.7500	111.125	4.3750	3.6	1.6	1 040	2 270	<b>93708/93127D</b>	1	193	295	17.5	3.6	1.6	0.52	1.29	1.92	1.26	47.2
	7.0856	319.976	12.5975	146.050	5.7500	111.125	4.3750	3.6	1.6	1 040	2 270	<b>93708/93128XD</b>	1*	193	295	17.5	3.6	1.6	0.52	1.29	1.92	1.26	48.3
180	—	280	—	74	—	66	—	3	1	464	801	<b>46236</b>	1	194	263	4	2.5	1	0.33	2.03	3.02	1.98	15.5
	—	280	—	93	—	74	—	3	1	584	1 080	<b>46236A</b>	1	194	261	9.5	2.5	1	0.33	2.03	3.02	1.98	19.0
	—	300	—	96	—	85	—	4	1.5	693	1 240	<b>46336</b>	1	198	277	5.5	3	1.5	0.33	2.06	3.06	2.01	25.8
	—	300	—	120	—	96	—	4	1.5	894	1 630	<b>46336A</b>	1	198	279	12	3	1.5	0.33	2.06	3.06	2.01	31.3
	—	300	—	163	—	134	—	4	1	1 210	2 240	<b>46T363016</b>	1	198	282	14.5	3	1	0.33	2.03	3.02	1.98	42.2
	—	320	—	127	—	99	—	4	1.5	1 060	1 740	<b>46T30236JR/99</b>	1	202	297	14	4	1.5	0.45	1.5	2.23	1.47	40.1
	—	320	—	192	—	152	—	4	1.5	1 640	3 030	<b>46T32236JR/152</b>	1	202	303	20	4	1.5	0.45	1.5	2.23	1.47	62.5
	—	340	—	170	—	140	—	5	1.5	1 540	2 530	<b>46T363417</b>	1	202	314	15	4	1.5	0.32	2.12	3.15	2.07	63.2
184.150	7.2500	266.700	10.5000	103.188	4.0625	84.138	3.3125	3.6	0.8	614	1 520	<b>67883/67820D</b>	1	197	257	9.5	3.6	0.8	0.48	1.41	2.11	1.38	18.7
184.15	—	288.925	—	142.88	—	111.12	—	SP	SP	968	1 920	<b>46T372914</b>	1	203.2	276	15.9	4	SP	0.40	1.68	2.50	1.64	31.7
187.325	7.3750	266.700	10.5000	103.188	4.0625	84.138	3.3125	3.6	0.8	614	1 520	<b>67884/67820D</b>	1	200	257	9.5	3.6	0.8	0.48	1.41	2.11	1.38	18.0
	7.3750	269.875	10.6250	119.063	4.6875	93.663	3.6875	3.6	1.6	704	1 610	<b>M238849/M238810D</b>	1	200	255	12.7	3.6	1.6	0.33	2.03	3.02	1.98	20.4
	7.3750	282.575	11.1250	107.950	4.2500	79.375	3.1250	3.6	1.6	702	1 450	<b>87737/87112D</b>	1	200	267	14.3	3.6	1.6	0.42	1.62	2.42	1.59	21.4

[Notes] 1) While metric series bearings have minus tolerances for bore and OD, inch series have plus tolerances. Refer to page 190 for details of applicable tolerance standards.

2) SP indicates the specially chamfered form.

3) \* means no lubrication holes or grooves on double outer ring.

# Double-row tapered roller bearings

## TDO, TDOS type

$d$  (187.325) ~ 200 mm

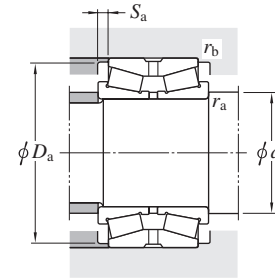
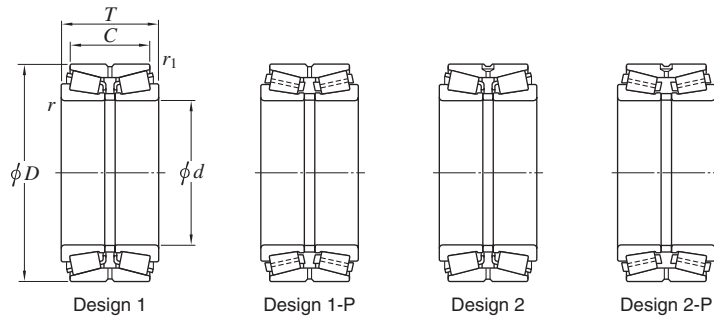

Boundary dimensions							Basic load ratings (kN)			Bearing No. <sup>1)</sup>	Design	Mounting dimensions (mm)					Constant $e$	Axial load factors			(Refer.) Mass (kg)
$d$ mm	$D$ mm	$T$ mm	$C$ mm	$r$ min.	$r_1$ min.	$C_r$	$C_{Or}$	$d_a$ min.	$D_a$ min.			$S_a$ min.	$r_a$ max.	$r_b$ max.	$e$	$Y_2$		$Y_3$	$Y_0$		
187.325	320.675	185.738	138.113	5.6	1.6	1 460	2 530	H239649/H239612D	1	204	301	23.8	5.6	1.6	0.32	2.12	3.15	2.07	52.6		
190	290	75	67	3	1	487	866	46238	1	204	272	4	2.5	1	0.32	2.12	3.15	2.07	16.5		
	290	94	75	3	1	632	1 170	46238A	1	204	274	9.5	2.5	1	0.33	2.03	3.02	1.98	20.0		
	320	104	92	4	1.5	808	1 450	46338	1	208	298	6	3	1.5	0.35	1.95	2.90	1.91	31.9		
	320	130	104	4	1.5	1 020	1 860	46338A	1	208	298	13	3	1.5	0.35	1.95	2.90	1.91	39.0		
	320	171	134	4	1	1 490	2 800	46T383217C	2	208	301	18.5	3	1	0.32	2.12	3.15	2.07	51.0		
	340	133	105	4	1.5	1 250	2 060	46T30238JR/105	1	212	318	14	4	1.5	0.44	1.55	2.31	1.52	47.8		
	340	204	160	4	1.5	1 870	3 480	46T32238JR/160	1	212	323	22	4	1.5	0.44	1.55	2.31	1.52	75.1		
190.500	266.700	103.188	84.138	3.6	0.8	614	1 520	67885/67820D	1	203	257	9.5	3.6	0.8	0.48	1.41	2.11	1.38	17.2		
	282.575	107.950	79.375	3.6	1.6	702	1 450	87750/87112D	1	203	267	14.3	3.6	1.6	0.42	1.62	2.42	1.59	20.7		
	317.500	146.050	111.125	4.3	1.6	1 040	2 270	93750/93127D	1	205	295	17.5	4.3	1.6	0.52	1.29	1.92	1.26	43.8		
	368.300	193.675	136.525	6.4	1.6	1 610	2 920	EE420751/421451D	1	209	334	28.6	6.4	1.6	0.40	1.68	2.50	1.64	85.2		
193.675	282.575	107.950	79.375	3.6	1.6	702	1 450	87762/87112D	1	206	267	14.3	3.6	1.6	0.42	1.62	2.42	1.59	19.8		
196.850	254.000	61.910	47.625	1.6	0.8	322	773	L540049/L540010D	1	206	244	7.1	1.6	0.8	0.40	1.70	2.53	1.66	7.12		
	257.175	85.725	66.675	3.6	0.8	459	1 260	LM739749/LM739710D	1	210	247	9.5	3.6	0.8	0.45	1.51	2.25	1.48	11.2		
200	310	82	73	3	1	572	1 040	46240	1	214	288	4.5	2.5	1	0.32	2.12	3.15	2.07	21.4		
	310	103	82	3	1	713	1 380	46240A	1	214	289	10.5	2.5	1	0.32	2.12	3.15	2.07	26.3		
	310	152	123	3	1	1 290	2 670	46T403115	1	214	298	14.5	2.5	1	0.43	1.57	2.34	1.53	39.9		
	310	170	140	3	1	1 240	2 730	46T4031	1	214	292	15	2.5	1	0.33	2.03	3.02	1.98	44.9		
	320	146	110	5	1.5	1 040	2 270	46T403215	1	222	295	18	4	1.5	0.52	1.29	1.92	1.26	41.5		
	330	180	140	4	1.5	1 340	2 690	46T403318	1	218	307	20	3	1.5	0.36	1.87	2.79	1.83	56		
	340	112	100	4	1.5	939	1 580	46340	1	218	316	6	3	1.5	0.35	1.95	2.90	1.91	39.6		
	340	140	112	4	1.5	1 110	2 040	46340A	1	218	319	14	3	1.5	0.35	1.95	2.90	1.91	48.2		
	356	152	111	6	1.5	1 250	2 610	46T403615	1	209	333	20	5	1.5	0.33	2.04	3.04	2.00	61.6		
	360	142	110	4	1.5	1 360	2 240	46T30240JR/110	1	222	336	16	4	1.5	0.44	1.55	2.31	1.52	56.5		

[Note] 1) While metric series bearings have minus tolerances for bore and OD, inch series have plus tolerances. Refer to page 190 for details of applicable tolerance standards.

### Double-row tapered roller bearings

TDO, TDOS type

*d* 200.025 ~ (220) mm

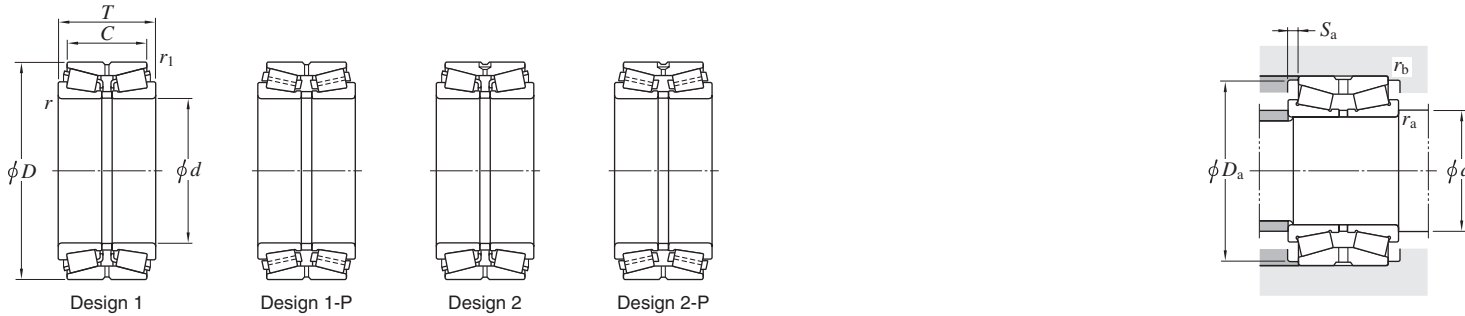

Boundary dimensions							Basic load ratings (kN)				Bearing No. 1)	Design	Mounting dimensions (mm)					Constant <i>e</i>	Axial load factors			(Refer.) Mass (kg)	
<i>d</i> mm	<i>D</i> mm	<i>T</i> mm	<i>C</i> mm	<i>r</i> <sup>2)</sup> mm	<i>r</i> <sub>1</sub> <sup>2)</sup> mm	<i>C<sub>r</sub></i>	<i>C</i> <sub>0r</sub>	<i>d</i> <sub>a</sub> min.	<i>D</i> <sub>a</sub> min.	<i>S</i> <sub>a</sub> min.			<i>r</i> <sub>a</sub> max.	<i>r</i> <sub>b</sub> max.	<i>Y</i> <sub>2</sub>	<i>Y</i> <sub>3</sub>	<i>Y</i> <sub>0</sub>						
200.025	7.8750	317.500	12.5000	146.050	5.7500	111.125	4.3750	4.3	1.6	1 040	2 270	<b>93787/93127D</b>	1	215	294.5	17.5	4.3	1.6	0.52	1.29	1.92	1.26	40.5
	7.8750	355.600	14.0000	152.400	6.0000	111.125	4.3750	6.7	1.6	1 250	2 610	<b>EE130787/131401D</b>	1	220	330	20.6	6.7	1.6	0.33	2.04	3.04	2.00	61.8
	7.8750	384.175	15.1250	238.125	9.3750	193.675	7.6250	6.4	1.6	2 480	5 370	<b>H247535/H247510D</b>	1-P	219	362	22.2	6.4	1.6	0.33	2.03	3.02	1.98	126
203.200	8.0000	276.225	10.8750	90.485	3.5624	73.025	2.8750	3.6	0.8	643	1 430	<b>LM241149/LM241110D</b>	1	217	265	8.7	3.6	0.8	0.32	2.12	3.15	2.07	14.7
	8.0000	282.575	11.1250	101.600	4.0000	82.550	3.2500	3.6	0.8	598	1 410	<b>67983/67920D</b>	1	217	272	9.5	3.6	0.8	0.51	1.33	1.97	1.30	18.3
	8.0000	292.100	11.5000	125.415	4.9376	101.600	4.0000	3.6	1.6	934	2 050	<b>M241547/M241510D</b>	1	217	278	11.9	3.6	1.6	0.33	2.03	3.02	1.98	24.9
	8.0000	317.500	12.5000	146.050	5.7500	111.125	4.3750	4.3	1.6	1 040	2 270	<b>93800/93127D</b>	1	218	295	17.5	4.3	1.6	0.52	1.29	1.92	1.26	39.3
	8.0000	317.500	12.5000	146.050	5.7500	111.125	4.3750	7.9	1.6	1 040	2 270	<b>93800A/93127D</b>	1	225	295	17.5	7.9	1.6	0.52	1.29	1.92	1.26	39.2
	8.0000	368.300	14.5000	193.675	7.6250	136.525	5.3750	3.2	1.6	1 610	2 920	<b>EE420801/421451D</b>	1	216	334	28.6	3.2	1.6	0.40	1.68	2.50	1.64	79.4
	8.0000	406.400	16.0000	196.850	7.7500	127.000	5.0000	6.4	3.2	1 630	2 920	<b>EE114080/114161D</b>	1	222	368	34.9	6.4	3.2	0.79	0.85	1.27	0.83	105
	8.0625	292.100	11.5000	125.415	4.9376	101.600	4.0000	3.6	1.6	934	2 050	<b>M241549/M241510D</b>	1	218	278	11.9	3.6	1.6	0.33	2.03	3.02	1.98	24.4
206.375	8.1250	282.575	11.1250	101.600	4.0000	82.550	3.2500	3.6	0.8	598	1 410	<b>67985/67920D</b>	1	220	271.5	9.5	3.6	0.8	0.51	1.33	1.97	1.30	17.5
	8.1250	317.500	12.5000	127.000	5.0000	88.900	3.5000	4	1.6	753	1 450	<b>EE132084/132126D</b>	1	221	293	19.1	4	1.6	0.31	2.15	3.21	2.11	30.9
	8.1250	336.550	13.2500	211.138	8.3125	169.863	6.6875	3.2	1.6	1 770	3 800	<b>H242649/H242610DC</b>	2	219	318	20.6	3.2	1.6	0.33	2.03	3.02	1.98	69.7
209.550	8.2500	282.575	11.1250	101.600	4.0000	82.550	3.2500	3.6	0.8	598	1 410	<b>67989/67920D</b>	1	223	272	9.5	3.6	0.8	0.51	1.33	1.97	1.30	16.7
	8.2500	317.500	12.5000	146.050	5.7500	111.125	4.3750	4.3	1.6	1 040	2 270	<b>93825/93127D</b>	1	225	295	17.5	4.3	1.6	0.52	1.29	1.92	1.26	37.0
	8.2500	333.375	13.1250	149.225	5.8750	114.300	4.5000	6.4	1.6	1 210	2 480	<b>HM743345/HM743310D</b>	1	229	316	17.5	6.4	1.6	0.44	1.54	2.29	1.50	45.9
210	—	300	—	110	—	85	—	1	1	752	1 550	<b>46T423011</b>	1	224	287	12.5	1	1	0.38	1.78	2.64	1.74	21.8
212.725	8.3750	285.750	11.2500	98.425	3.8750	76.200	3.0000	3.6	0.8	611	1 560	<b>LM742745/LM742710D</b>	1	226	277	11.1	3.6	0.8	0.48	1.40	2.09	1.37	16.8
215.900	8.5000	285.750	11.2500	98.425	3.8750	76.200	3.0000	3.6	0.8	611	1 560	<b>LM742749/LM742710D</b>	1	230	277	11.1	3.6	0.8	0.48	1.40	2.09	1.37	15.9
	8.5000	406.400	16.0000	195.263	7.6875	147.638	5.8125	6.4	1.6	1 930	3 480	<b>EE820085/820161D</b>	1	235	372	23.8	6.4	1.6	0.39	1.71	2.55	1.67	103
219.075	8.6250	358.775	14.1250	196.850	7.7500	181.440	7.1433	SP	SP	1 660	3 590	<b>46T443620</b>	2	237.9	338	7.7	4	1	0.33	2.03	3.02	1.98	78.3
220	—	340	—	90	—	80	—	4	1.5	677	1 240	<b>46244</b>	1	238	319	5	3	1.5	0.32	2.12	3.15	2.07	27.8
	—	340	—	113	—	90	—	4	1.5	832	1 620	<b>46244A</b>	1	238	318	11.5	3	1.5	0.32	2.12	3.15	2.07	34.2

[Notes] 1) While metric series bearings have minus tolerances for bore and OD, inch series have plus tolerances. Refer to page 190 for details of applicable tolerance standards.

2) SP indicates the specially chamfered form.

# Double-row tapered roller bearings

## TDO, TDOS type

d (220) ~ 234.950 mm

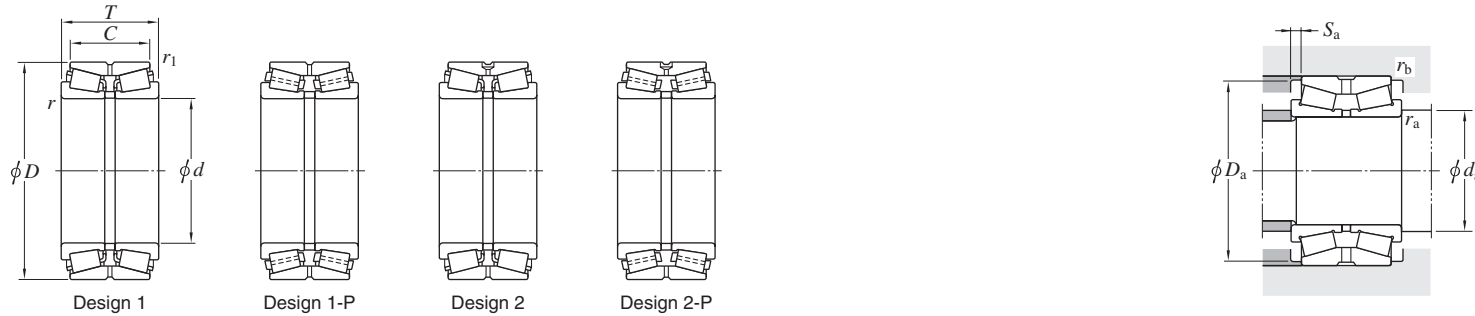

Boundary dimensions								Basic load ratings (kN)		Bearing No. <sup>1)</sup>	Design	Mounting dimensions (mm)					Constant <i>e</i>	Axial load factors			(Refer.) Mass (kg)		
<i>d</i> mm	<i>D</i> mm		<i>T</i> mm		<i>C</i> mm		<i>r</i> <sup>2)</sup> min.	<i>r</i> <sub>1</sub> <sup>2)</sup> min.	<i>C<sub>r</sub></i>			<i>C<sub>0r</sub></i>	<i>d<sub>a</sub></i> min.	<i>D<sub>a</sub></i> min.	<i>S<sub>a</sub></i> min.	<i>r<sub>a</sub></i> max.		<i>r<sub>b</sub></i> max.	<i>e</i>	<i>Y<sub>2</sub></i>		<i>Y<sub>3</sub></i>	<i>Y<sub>0</sub></i>
220	—	370	—	120	—	107	—	5	1.5	1 070	1 810	<b>46344</b>	1	242	346	6.5	4	1.5	0.35	1.95	2.90	1.91	49.1
	—	370	—	150	—	120	—	5	1.5	1 330	2 470	<b>46344A</b>	1	242	343	15	4	1.5	0.35	1.95	2.90	1.91	60.1
	—	400	—	150	—	114	—	4	1.5	1 730	2 880	<b>46T30244JR/114</b>	1	242	371	18	4	1.5	0.42	1.61	2.39	1.57	75.8
220.663	8.6875	314.325	12.3750	131.763	5.1875	106.363	4.1875	6.4	1.6	1 050	2 450	<b>M244249/M244210D</b>	1	240	299	12.7	6.4	1.6	0.33	2.03	3.02	1.98	30.5
225.425	8.8750	355.600	14.0000	152.400	6.0000	111.125	4.3750	6.7	1.6	1 250	2 610	<b>EE130889/131401D</b>	1	245	330	20.6	6.7	1.6	0.33	2.04	3.04	2.00	51.8
228.397	8.9920	431.800	17.0000	196.850	7.7500	111.125	4.3750	6.4	3.2	1 700	2 890	<b>EE113089/113171D</b>	1-P	248	397	42.9	6.4	3.2	0.88	0.76	1.14	0.75	111
228.460	8.9945	431.800	17.0000	196.850	7.7500	111.125	4.3750	6.4	3.2	1 700	2 890	<b>EE113091/113171D</b>	1-P	248	397	42.9	6.4	3.2	0.88	0.76	1.14	0.75	111
228.600	9.0000	327.025	12.8750	114.300	4.5000	82.550	3.2500	6.4	1.6	802	1 860	<b>8573/8520D</b>	1	248	310	15.9	6.4	1.6	0.41	1.66	2.47	1.62	28.2
	9.0000	355.600	14.0000	152.400	6.0000	111.125	4.3750	7.1	1.6	1 130	2 630	<b>96900/96140D</b>	1	249	332	20.6	7.1	1.6	0.59	1.14	1.70	1.12	52.3
	9.0000	355.600	14.0000	152.400	6.0000	111.125	4.3750	6.7	1.6	1 250	2 610	<b>EE130902/131401D</b>	1	248	330	20.6	6.7	1.6	0.33	2.04	3.04	2.00	50.4
	9.0000	355.600	14.0000	152.400	6.0000	114.300	4.5000	6.4	1.6	1 320	2 740	<b>HM746646/HM746610D</b>	1	248	339	19.1	6.4	1.6	0.47	1.43	2.12	1.40	51.5
	9.0000	358.775	14.1250	152.400	6.0000	117.475	4.6250	3.6	1.6	1 330	3 170	<b>M249732/M249710D</b>	1	242	343	17.5	3.6	1.6	0.33	2.03	3.02	1.98	56.4
	9.0000	400.050	15.7500	187.325	7.3750	136.525	5.3750	10.4	1.6	1 690	3 210	<b>EE430900/431576D</b>	1	256	374	25.4	10.4	1.6	0.44	1.54	2.29	1.50	87.4
	9.0000	425.450	16.7500	209.550	8.2500	158.750	6.2500	7.1	1.6	2 010	3 950	<b>EE700091/700168D</b>	1	249	382	25.4	7.1	1.6	0.33	2.03	3.02	1.98	123
9.0000	488.950	19.2500	345.000	13.5827	220.000	8.6614	SP	SP	3 640	7 010	<b>46T464935B</b>	1-P	246.6	465	62.5	4	1	0.94	0.72	1.07	0.70	298	
230	—	380	—	200	—	160	—	4	1	1 940	4 070	<b>46T463820</b>	1	248	354	20	3	1	0.26	2.55	3.80	2.50	86.1
	—	410	—	180	—	120	—	5	1.5	1 700	3 060	<b>46T464118</b>	1	252	381	30	4	1.5	0.55	1.23	1.82	1.20	89.5
	—	420	—	200	—	160	—	5	1.5	1 960	3 630	<b>46T464220</b>	2	252	391	20	4	1.5	0.47	1.43	2.12	1.40	114
	—	430	—	215	—	130	—	6	1.5	2 060	3 700	<b>46T464322A</b>	1-P	258	410	42.5	5	1.5	0.94	0.72	1.07	0.70	126
231.775	9.1250	358.775	14.1250	152.400	6.0000	117.475	4.6250	6.4	1.6	1 330	3 170	<b>M249734/M249710D</b>	1	251	343	17.5	6.4	1.6	0.33	2.03	3.02	1.98	55.0
234.950	9.2500	327.025	12.8750	114.300	4.5000	82.550	3.2500	6.4	1.6	802	1 860	<b>8575/8520D</b>	1	254	310	15.9	6.4	1.6	0.41	1.66	2.47	1.62	26.2
	9.2500	355.600	14.0000	152.400	6.0000	111.125	4.3750	7.1	1.6	1 130	2 630	<b>96925/96140D</b>	1	256	332	20.6	7.1	1.6	0.59	1.14	1.70	1.12	49.5
	9.2500	384.175	15.1250	238.125	9.3750	193.675	7.6250	6.4	1.6	2 480	5 370	<b>H247548/H247510D</b>	1-P	254	362	22.2	6.4	1.6	0.33	2.03	3.02	1.98	104
	9.2500	384.175	15.1250	238.125	9.3750	193.675	7.6250	6.4	1.6	2 480	5 370	<b>H247549/H247510D</b>	1-P	254	362	22.2	6.4	1.6	0.33	2.03	3.02	1.98	104

[Notes] 1) While metric series bearings have minus tolerances for bore and OD, inch series have plus tolerances. Refer to page 190 for details of applicable tolerance standards.

2) SP indicates the specially chamfered form.



### Double-row tapered roller bearings

#### TDO, TDOS type

*d* 237.330 ~ (254.000) mm

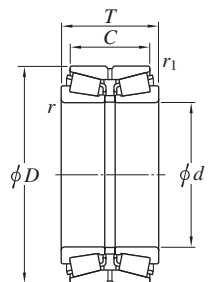

Design 1

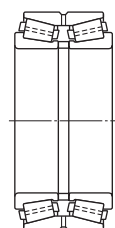

Design 1-P

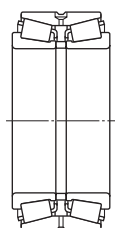

Design 2



Design 2-P

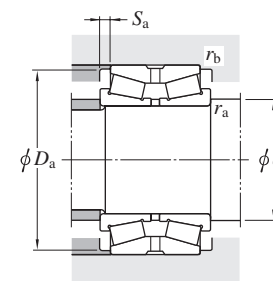

Boundary dimensions								Basic load ratings (kN)		Bearing No. 1)	Design	Mounting dimensions (mm)					Constant <i>e</i>	Axial load factors			(Refer.) Mass (kg)		
<i>d</i> mm	<i>D</i> mm	<i>T</i> mm	<i>C</i> mm	<i>r</i> <sup>2)</sup> min.	<i>r</i> <sub>1</sub> <sup>2)</sup> min.	<i>C<sub>r</sub></i>	<i>C<sub>0r</sub></i>	<i>d<sub>a</sub></i> min.	<i>D<sub>a</sub></i> min.			<i>S<sub>a</sub></i> min.	<i>r<sub>a</sub></i> max.	<i>r<sub>b</sub></i> <sup>2)</sup> max.	<i>e</i>	<i>Y</i> <sub>2</sub>		<i>Y</i> <sub>3</sub>	<i>Y</i> <sub>0</sub>				
<b>237.330</b>	9.3437	358.775	14.1250	152.400	6.0000	117.475	4.6250	6.4	1.6	1 330	3 170	<b>M249736/M249710D</b>	1	257	343	17.5	6.4	1.6	0.33	2.03	3.02	1.98	52.6
<b>240</b>	—	360	—	92	—	82	—	4	1.5	768	1 430	<b>46248</b>	1	258	338	5	3	1.5	0.32	2.12	3.15	2.07	29.6
		360	—	115	—	92	—	4	1.5	990	1 980	<b>46248A</b>	1	258	341	11.5	3	1.5	0.32	2.12	3.15	2.07	36.9
		360	—	170	—	142	—	4	1	1 300	3 090	<b>46T483617</b>	2	258	345	14	3	1	0.33	2.03	3.02	1.98	57.3
		400	—	128	—	114	—	5	1.5	1 190	2 180	<b>46348</b>	1	262	377	7	4	1.5	0.35	1.95	2.90	1.91	59.0
		400	—	160	—	128	—	5	1.5	1 540	3 060	<b>46348A</b>	1	262	373	16	4	1.5	0.35	1.95	2.90	1.91	76.2
		400	—	209	—	168	—	5	1.5	2 200	4 370	<b>46T484021</b>	1	262	378	20.5	4	1.5	0.33	2.03	3.02	1.98	98.5
		407	—	216	—	185	—	SP	SP	2 340	4 810	<b>46T484122</b>	1	258.8	385	15.5	4	SP	0.33	2.03	3.02	1.98	111
		440	—	274	—	224	—	5	1.5	3 360	6 850	<b>46T484427</b>	1	249	412	25	4	1.5	0.33	2.03	3.02	1.98	179
<b>241.300</b>	9.5000	327.025	12.8750	114.300	4.5000	82.550	3.2500	6.4	1.6	802	1 860	<b>8578/8520D</b>	1	261	310	15.9	6.4	1.6	0.41	1.66	2.47	1.62	24.1
	9.5000	349.148	13.7460	127.000	5.0000	101.600	4.0000	6.4	1.6	950	2 050	<b>EE127095/127136D</b>	1	261	330	12.7	6.4	1.6	0.35	1.91	2.84	1.86	36.4
	9.5000	355.498	13.9960	127.000	5.0000	101.600	4.0000	6.4	1.6	950	2 050	<b>EE127095/127139D</b>	1	261	330	12.7	6.4	1.6	0.35	1.91	2.84	1.86	39.1
	9.5000	368.300	14.5000	120.650	4.7500	85.725	3.3750	6.4	1.6	870	1 850	<b>EE170950/171451D</b>	1	261	336	17.5	6.4	1.6	0.36	1.86	2.77	1.82	41.7
	9.5000	393.700	15.5000	157.163	6.1875	109.538	4.3125	6.4	1.6	1 270	3 090	<b>EE275095/275156D</b>	1	261	378	23.8	6.4	1.6	0.40	1.68	2.50	1.64	73.3
	9.5000	406.400	16.0000	155.575	6.1250	107.950	4.2500	6.4	1.6	1 270	3 090	<b>EE275095/275161D</b>	1	261	378	23.8	6.4	1.6	0.40	1.68	2.50	1.64	79.3
	9.5000	406.400	16.0000	215.900	8.5000	184.150	7.2500	6.4	1.6	2 340	4 810	<b>H249148/H249111D</b>	1	261	385	15.9	6.4	1.6	0.33	2.03	3.02	1.98	110
	9.5000	444.500	17.5000	209.550	8.2500	158.750	6.2500	6.4	1.6	2 200	3 960	<b>EE923095/923176D</b>	1	261	407	25.4	6.4	1.6	0.34	2.01	2.99	1.96	128
	9.5000	488.950	19.2500	254.000	10.0000	196.850	7.7500	6.4	1.6	2 880	5 570	<b>EE295950/295192D</b>	1	261	446	28.6	6.4	1.6	0.31	2.18	3.24	2.13	209
<b>244.475</b>	9.6250	380.898	14.9960	171.450	6.7500	127.000	5.0000	6.4	1.6	1 350	2 930	<b>EE126097/126149D</b>	1	264	357	22.2	6.4	1.6	0.52	1.31	1.95	1.28	65.9
	9.6250	381.000	15.0000	171.450	6.7500	127.000	5.0000	6.4	1.6	1 350	2 930	<b>EE126097/126151D</b>	1	264	357	22.2	6.4	1.6	0.52	1.31	1.95	1.28	66.0
<b>247.650</b>	9.7500	368.300	14.5000	120.650	4.7500	85.725	3.3750	6.4	1.6	870	1 850	<b>EE170975/171451D</b>	1	267	336	17.5	6.4	1.6	0.36	1.86	2.77	1.82	39.4
	9.7500	406.400	16.0000	247.650	9.7500	203.200	8.0000	6.4	1.6	2 770	6 250	<b>HH249949/HH249910D</b>	1-P	267	383	22.2	6.4	1.6	0.33	2.03	3.02	1.98	123
<b>249.250</b>	9.8130	380.898	14.9960	171.450	6.7500	127.000	5.0000	6.4	1.6	1 350	2 930	<b>EE126098/126149D</b>	1	269	357	22.2	6.4	1.6	0.52	1.31	1.95	1.28	63.5
	9.8130	381.000	15.0000	171.450	6.7500	127.000	5.0000	6.4	1.6	1 350	2 930	<b>EE126098/126151D</b>	1	269	357	22.2	6.4	1.6	0.52	1.31	1.95	1.28	63.5
<b>254.000</b>	10.0000	347.663	13.6875	101.600	4.0000	69.850	2.7500	3.6	1.6	808	1 690	<b>LM249748/LM249710D</b>	1	268	332	15.9	3.6	1.6	0.33	2.03	3.02	1.98	24.1

[Notes] 1) While metric series bearings have minus tolerances for bore and OD, inch series have plus tolerances. Refer to page 190 for details of applicable tolerance standards.

2) SP indicates the specially chamfered form.

# Double-row tapered roller bearings

## TDO, TDOS type

*d* (254.000) ~ 260.350 mm

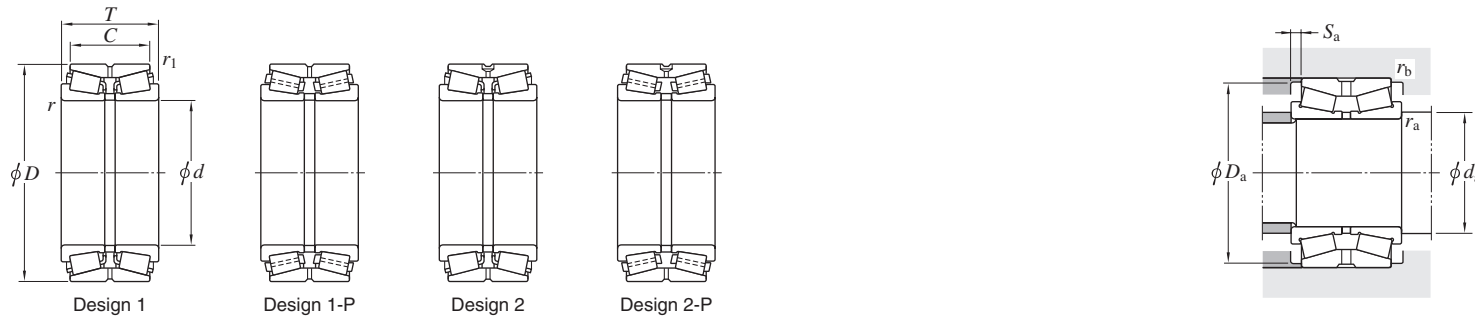

Boundary dimensions								Basic load ratings (kN)		Bearing No. <sup>1)</sup>	Design	Mounting dimensions (mm)					Constant <i>e</i>	Axial load factors			(Refer.) Mass (kg)			
<i>d</i>	<i>D</i>	<i>T</i>	<i>C</i>	<i>r</i>	<i>r</i> <sub>1</sub>	<i>C<sub>r</sub></i>	<i>C<sub>0r</sub></i>	<i>d<sub>a</sub></i>	<i>D<sub>a</sub></i>			<i>S<sub>a</sub></i>	<i>r<sub>a</sub></i>	<i>r<sub>b</sub></i>	<i>Y<sub>2</sub></i>	<i>Y<sub>3</sub></i>		<i>Y<sub>0</sub></i>						
mm	mm	mm	mm	min.	min.			min.	min.	min.	max.	max.												
254.000	10.0000	358.775	14.1250	152.400	6.0000	117.475	4.6250	3.6	1.6	1 330	3 170	<b>M249749/M249710D</b>	1	268	343	17.5	3.6	1.6	0.33	2.03	3.02	1.98	45.0	
	10.0000	365.125	14.3750	130.175	5.1250	98.425	3.8750	6.4	1.6	970	2 150	<b>EE134100/134144D</b>	1	273	346	15.9	6.4	1.6	0.37	1.80	2.69	1.76	39.8	
	10.0000	393.700	15.5000	157.163	6.1875	109.538	4.3125	6.4	1.6	1 270	3 090	<b>EE275100/275156D</b>	1	273	378	23.8	6.4	1.6	0.40	1.68	2.50	1.64	67.3	
	10.0000	406.400	16.0000	155.575	6.1250	107.950	4.2500	6.4	1.6	1 270	3 090	<b>EE275100/275161D</b>	1	273	378	23.8	6.4	1.6	0.40	1.68	2.50	1.64	73.4	
	10.0000	422.275	16.6250	173.038	6.8125	128.588	5.0625	6.7	1.6	1 730	3 360	<b>HM252343/HM252311D</b>	1	274	398	22.2	6.7	1.6	0.33	2.03	3.02	1.98	87.0	
	10.0000	422.275	16.6250	173.038	6.8125	128.588	5.0625	6.7	1.6	1 730	3 360	<b>HM252344/HM252311D</b>	1	274	398	22.2	6.7	1.6	0.33	2.03	3.02	1.98	87.0	
	10.0000	422.275	16.6250	178.592	7.0312	139.700	5.5000	6.7	1.6	1 730	3 360	<b>HM252343/HM252310D</b>	1	274	400	19.4	6.7	1.6	0.33	2.03	3.02	1.98	89.8	
	10.0000	422.275	16.6250	178.592	7.0312	139.700	5.5000	6.7	1.6	1 730	3 360	<b>HM252344/HM252310D</b>	1	274	400	19.4	6.7	1.6	0.33	2.03	3.02	1.98	89.8	
	10.0000	431.724	16.9970	173.038	6.8125	128.588	5.0625	6.7	1.6	1 730	3 360	<b>HM252343/HM252315D</b>	1	274	398	22.2	6.7	1.6	0.33	2.03	3.02	1.98	93.3	
	10.0000	431.724	16.9970	173.038	6.8125	128.588	5.0625	6.7	1.6	1 730	3 360	<b>HM252344/HM252315D</b>	1	274	398	22.2	6.7	1.6	0.33	2.03	3.02	1.98	93.3	
	10.0000	533.400	21.0000	276.225	10.8750	165.100	6.5000	6.4	1.6	3 050	5 600	<b>HH953749/HH953710D</b>	1-P	273	496	55.6	6.4	1.6	0.94	0.72	1.07	0.70	267	
	260	—	400	—	104	—	92	—	5	1.5	935	1 830	<b>46252</b>	1	282	373	6	4	1.5	0.33	2.03	3.02	1.98	44.6
		—	400	—	130	—	104	—	5	1.5	1 210	2 480	<b>46252A</b>	1	282	376	13	4	1.5	0.32	2.12	3.15	2.07	54.8
—		400	—	146	—	108	—	6	1.5	1 300	2 570	<b>46T524015</b>	1	288	374	19	5	1.5	0.39	1.71	2.54	1.67	65.0	
—		400	—	185	—	146	—	5	1.5	1 790	3 690	<b>46T524019</b>	1	282	378.4	19.5	4	1.5	0.29	2.32	3.45	2.26	77.1	
—		440	—	144	—	128	—	5	1.5	1 510	2 880	<b>46352</b>	1	282	410	8	4	1.5	0.35	1.95	2.90	1.91	83.8	
—		440	—	172	—	145	—	5	1.5	1 770	3 170	<b>46T524417</b>	1	282	414	13.5	4	1.5	0.43	1.59	2.36	1.55	97	
—		440	—	180	—	144	—	5	1.5	2 010	3 960	<b>46352A</b>	1	282	409	18	4	1.5	0.35	1.95	2.90	1.91	105	
—		440	—	224	—	180	—	5	1.5	2 700	5 350	<b>46T524422</b>	1	282	409	22	4	1.5	0.24	2.84	4.23	2.78	130	
—		530	—	275	—	163.9	—	6	1.5	2 790	4 910	<b>46T525328</b>	1-P	288	506	55	5	1.5	1.18	0.57	0.85	0.56	255	
260.350	10.2500	365.125	14.3750	130.175	5.1250	98.425	3.8750	6.4	1.6	970	2 150	<b>EE134102/134144D</b>	1	280	355	15.9	6.4	1.6	0.37	1.80	2.69	1.76	37.2	
	10.2500	400.050	15.7500	155.575	6.1250	107.950	4.2500	9.5	1.6	1 300	2 570	<b>EE221026/221576D</b>	1	286	372	23.8	9.5	1.6	0.39	1.71	2.54	1.67	58.4	
	10.2500	422.275	16.6250	173.038	6.8125	128.588	5.0625	6.7	1.6	1 730	3 360	<b>HM252348/HM252311D</b>	1	280	398	22.2	6.7	1.6	0.33	2.03	3.02	1.98	83.6	
	10.2500	422.275	16.6250	178.592	7.0312	139.700	5.5000	6.7	1.6	1 730	3 360	<b>HM252348/HM252310D</b>	1	280	400	19.4	6.7	1.6	0.33	2.03	3.02	1.98	86.3	
	10.2500	422.275	16.6250	178.592	7.0312	139.700	5.5000	6.7	1.6	1 730	3 360	<b>HM252349/HM252310D</b>	1	280	400	19.4	6.7	1.6	0.33	2.03	3.02	1.98	86.3	
	10.2500	431.724	16.9970	173.038	6.8125	128.588	5.0625	6.7	1.6	1 730	3 360	<b>HM252348/HM252315D</b>	1	280	398	22.2	6.7	1.6	0.33	2.03	3.02	1.98	89.9	
	10.2500	431.724	16.9970	173.038	6.8125	128.588	5.0625	6.7	1.6	1 730	3 360	<b>HM252349/HM252315D</b>	1	280	398	22.2	6.7	1.6	0.33	2.03	3.02	1.98	89.9	
	10.2500	488.950	19.2500	254.000	10.0000	196.850	7.7500	6.4	1.6	2 880	5 570	<b>EE295102/295192D</b>	1	280	446	28.6	6.4	1.6	0.31	2.18	3.24	2.13	194	

[Note] 1) While metric series bearings have minus tolerances for bore and OD, inch series have plus tolerances. Refer to page 190 for details of applicable tolerance standards.

# Double-row tapered roller bearings

## TDO, TDOS type

$d$  263.525 ~ 280.192 mm

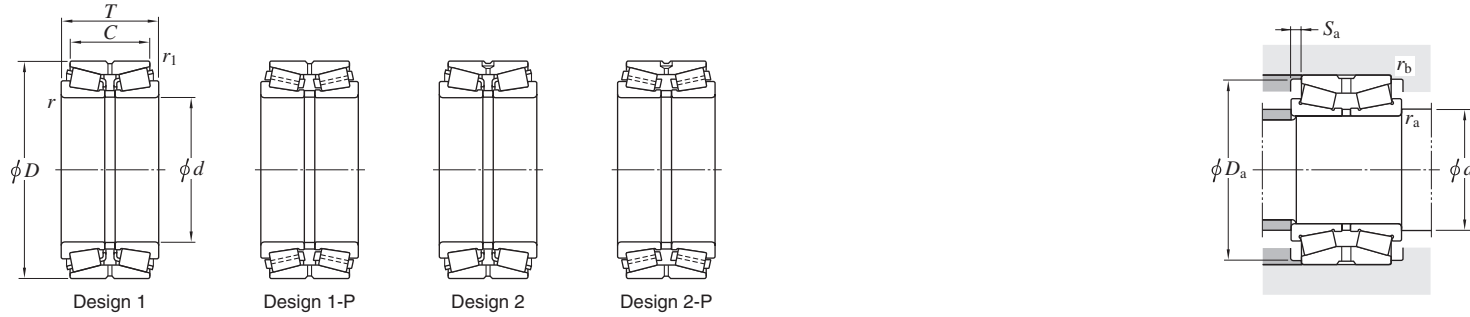

Boundary dimensions								Basic load ratings (kN)		Bearing No. <sup>1)</sup>	Design	Mounting dimensions (mm)					Constant $e$	Axial load factors			(Refer.) Mass (kg)
$d$ mm	$D$ mm	$T$ mm	$C$ mm	$r^{(2)}$ min.	$r_1^{(2)}$ min.	$C_r$	$C_{Or}$	$d_a$ min.	$D_a$ min.			$S_a$ min.	$r_a$ max.	$r_b^{(2)}$ max.	$e$	$Y_2$		$Y_3$	$Y_0$		
263.525	10.3750 355.600	14.0000 127.000	5.0000 101.600	4.0000 3.6	1.6 1.6	1 040	2 550	LM451345/LM451310D	1	277	343	12.7	3.6	1.6	0.36	1.87	2.79	1.83	33.1		
266.700	10.5000 357.200	14.0630 127.000	5.0000 101.600	4.0000 3.6	1.6 1.6	1 040	2 550	LM451349/LM451310D	1	280	343	12.7	3.6	1.6	0.36	1.87	2.79	1.83	31.8		
	10.5000 393.700	15.5000 157.163	6.1875 109.538	4.3125 4.3125	6.4 6.4	1.6 1.6	1 270	3 090	EE275105/275156D	1	286	378	23.8	6.4	1.5	0.40	1.68	2.50	1.64	60.9	
	10.5000 406.400	16.0000 155.575	6.1250 107.950	4.2500 4.2500	6.4 6.4	1.6 1.6	1 270	3 090	EE275105/275161D	1	286	378	23.8	6.4	1.5	0.40	1.68	2.50	1.64	67.1	
	10.5000 422.275	16.6250 178.598	7.0314 139.700	5.5000 5.5000	6.7 6.7	1.6 1.6	1 680	3 420	EE551050/551663D	1	287	390	19.4	6.7	1.6	0.33	2.03	3.02	1.98	82.6	
	10.5000 431.724	16.9970 173.038	6.8125 128.588	5.0625 5.0625	6.7 6.7	1.6 1.6	1 680	3 420	EE551050/551701D	1	287	389	22.2	6.7	1.6	0.33	2.03	3.02	1.98	85.9	
	269.875	10.6250 381.000	15.0000 158.750	6.2500 123.825	4.8750 4.8750	6.4 6.4	1.6 1.6	1 460	3 350	M252349/M252310D	1	289	364	17.5	6.4	1.6	0.33	2.03	3.02	1.98	51.4
273.050	10.7500 393.700	15.5000 157.163	6.1875 109.538	4.3125 4.3125	6.4 6.4	1.6 1.6	1 270	3 090	EE275108/275156D	1	292	378	23.8	6.4	1.6	0.40	1.68	2.50	1.64	57.6	
	10.7500 406.400	16.0000 155.575	6.1250 107.950	4.2500 4.2500	6.4 6.4	1.6 1.6	1 270	3 090	EE275108/275161D	1	292	378	23.8	6.4	1.6	0.40	1.68	2.50	1.64	63.8	
279.400	11.0000 469.900	18.5000 200.025	7.8750 149.225	5.8750 5.8750	9.5 9.5	1.6 1.6	2 100	4 370	EE722110/722186D	1	305	431	25.4	9.5	1.6	0.38	1.79	2.67	1.75	127	
	11.0000 488.950	19.2500 254.000	10.0000 196.850	7.7500 7.7500	1.2 1.2	1.6 1.6	2 880	5 570	EE295110/295192D	1	288	446	28.6	1.2	1.6	0.31	2.18	3.24	2.13	178	
279.982	11.0229 380.898	14.9960 139.700	5.5000 107.950	4.2500 4.2500	3.6 3.6	1.6 1.6	1 140	2 820	LM654642/LM654610D	1	294	371	15.9	3.6	1.6	0.43	1.57	2.34	1.53	42.7	
280	— 400	— 150	— 120	— SP	SP SP	— —	1 310	2 950	46T564015	1	302	386	15	4	SP	0.39	1.75	2.61	1.71	66.0	
280.000	11.0236 406.400	16.0000 149.225	5.8750 117.475	4.6250 4.6250	6.4 6.4	1.6 1.6	1 310	2 950	EE128112/128160D	1	299	383	15.9	6.4	1.6	0.39	1.75	2.61	1.71	58.8	
	11.0236 406.400	16.0000 149.225	5.8750 117.475	4.6250 4.6250	6.4 6.4	1.6 1.6	1 310	2 950	EE128114/128160D	1	299	383	15.9	6.4	1.6	0.39	1.75	2.61	1.71	58.8	
280	— 420	— 106	— 94	— 5	1.5 1.5	1 010	1 970	46256	1	302	395	6	4	1.5	0.33	2.03	3.02	1.98	46.9		
	— 420	— 133	— 106	— 5	1.5 1.5	1 250	2 610	46256A	1	302	394	13.5	4	1.5	0.33	2.03	3.02	1.98	58.9		
	— 460	— 146	— 130	— 6	2 2	1 550	2 930	46356	1	308	430	8	5	2	0.35	1.95	2.90	1.91	90.0		
	— 460	— 183	— 146	— 6	2 2	2 040	3 940	46356A	1	308	434	18.5	5	2	0.35	1.95	2.90	1.91	111		
	— 500	— 195	— 145	— 6	1.5 1.5	2 500	4 520	46T565020-1	1-P	308	461	25	5	1.5	0.40	1.68	2.50	1.64	150		
280.192	11.0312 406.400	16.0000 120.650	4.7500 85.725	3.3750 3.3750	6.7 6.7	1.6 1.6	894	1 980	EE101103/101601D	1	300	375	17.5	6.7	1.6	0.41	1.66	2.47	1.62	45.5	
	11.0312 406.400	16.0000 149.225	5.8750 117.475	4.6250 4.6250	6.7 6.7	1.6 1.6	1 310	2 950	EE128111/128160D	1	300	383	15.9	6.7	1.6	0.39	1.75	2.61	1.71	58.6	

[Notes] 1) While metric series bearings have minus tolerances for bore and OD, inch series have plus tolerances. Refer to page 190 for details of applicable tolerance standards.

2) SP indicates the specially chamfered form.

### Double-row tapered roller bearings

#### TDO, TDOS type

d 285.750 ~ 304.800 mm

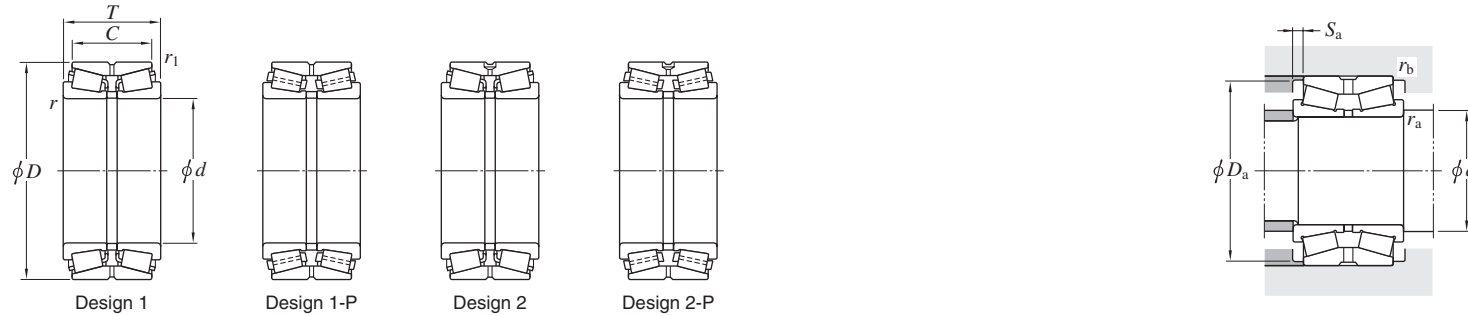

Boundary dimensions					Basic load ratings (kN)		Design	Mounting dimensions (mm)					Constant e	Axial load factors			(Refer.) Mass (kg)											
d	D	T	C	r <sup>2)</sup>	r <sub>1</sub>	C <sub>r</sub>		C <sub>0r</sub>	Bearing No. <sup>1)</sup>	d <sub>a</sub>	D <sub>a</sub>	S <sub>a</sub>		r <sub>a</sub>	r <sub>b</sub>	Y <sub>2</sub>		Y <sub>3</sub>	Y <sub>0</sub>									
mm	mm	mm	mm	mm	mm	mm	mm	mm	min.	max.	min.	min.	max.	min.	max.	min.	max.	min.										
285.750	11.2500	358.775	14.1250	76.200	3.0000	53.975	2.1250	545112/545142D LM654649/LM654610D EE147112/147198D	3.6	1.6	412	1 070	1	299	345	11.1	3.6	1.6	0.49	1.38	2.06	1.35	15.5					
	11.2500	380.898	14.9960	139.700	5.5000	107.950	4.2500		3.6	1.6	1 140	2 820		1	299	371	15.9	3.6	1.6	0.43	1.57	2.34	1.53	39.9				
	11.2500	501.650	19.7500	203.200	8.0000	120.650	4.7500		6.4	3.2	1 940	3 460		1	305	467	41.3	6.4	3.2	0.83	0.81	1.20	0.79	142				
288.925	11.3750	406.400	16.0000	165.100	6.5000	130.175	5.1250	M255449/M255410D	6.4	1.6	1 720	4 420	1	308	388	17.5	6.4	1.6	0.34	2.00	2.97	1.95	64.7					
290	—	400	—	120	—	90	—	46T584012 46T584117	5	1.5	1 190	2 600	1	312	385	15	4	1.5	0.42	1.61	2.40	1.58	40.1					
	—	405	—	165	—	130	—							SP	1	1 490	3 750	2	309	388	17.5	4	1	0.34	2.00	2.97	1.95	61.2
292.100	11.5000	374.650	14.7500	104.775	4.1250	79.375	3.1250	L555249/L555210D EE722115/722186D EE790114/790223D	3.6	1.6	802	1 940	1	306	361	12.7	3.6	1.6	0.40	1.68	2.50	1.64	25.6					
	11.5000	469.900	18.5000	200.025	7.8750	149.225	5.8750		9.5	1.6	2 100	4 370		1	318	431	25.4	9.5	1.6	0.38	1.79	2.67	1.75	118				
	11.5000	558.800	22.0000	298.450	11.7500	222.250	8.7500		6.4	1.6	4 040	8 000		1-P	311	515	38.1	6.4	1.6	0.40	1.71	2.54	1.67	307				
298.450	11.7500	444.500	17.5000	146.050	5.7500	98.425	3.8750	EE291175/291751D	7.9	1.6	1 240	2 760	1	321	414	23.8	7.9	1.6	0.38	1.79	2.66	1.75	69.3					
300	—	440	—	139	—	100	—	46T604414 46260 46260A 46360 46360A 46360D	4	0.6	1 360	2 870	1	318	412	19.5	3	0.6	0.37	1.80	2.69	1.76	63.8					
	—	460	—	118	—	105	—							5	1.5	1 290	2 400	1	322	436	6.5	4	1.5	0.32	2.12	3.15	2.07	64.6
	—	460	—	148	—	118	—							5	1.5	1 630	3 230	1	322	433	15	4	1.5	0.32	2.12	3.15	2.07	80.2
	—	500	—	160	—	142	—							6	2	1 980	3 540	1	328	469	9	5	2	0.35	1.95	2.90	1.91	116
	—	500	—	200	—	160	—							6	2	2 270	4 630	1	328	466	20	5	2	0.35	1.95	2.90	1.91	144
	—	500	—	200	—	160	—							6	1.5	2 500	4 650	1	328	475	20	5	1.5	0.40	1.68	2.50	1.64	139
300.038	11.8125	422.275	16.6250	174.625	6.8750	136.525	5.3750	HM256849/HM256810D	6.4	1.6	1 700	4 030	1	320	403	19.1	6.4	1.6	0.34	2.00	2.98	1.96	70.1					
304.800	12.0000	393.700	15.5000	107.950	4.2500	82.550	3.2500	L357049/L357010D EE109120/109163D EE291201/291751D EE941205/941951D EE941205/941953D EE724119/724196D EE724120/724196D EE790120/790223D	6.4	1.6	899	2 360	1	325	379	12.7	6.4	1.6	0.36	1.88	2.80	1.84	30.7					
	12.0000	412.750	16.2500	123.825	4.8750	92.075	3.6250		6.4	1.6	1 020	2 410		1	325	394	15.9	6.4	1.6	0.43	1.58	2.35	1.55	42.1				
	12.0000	444.500	17.5000	146.050	5.7500	98.425	3.8750		7.9	1.6	1 240	2 760		1	328	414	23.8	7.9	1.6	0.38	1.79	2.66	1.75	65.9				
	12.0000	495.300	19.5000	162.245	6.3876	120.650	4.7500		6.4	1.6	1 880	3 840		1	315	463	20.8	6.4	1.6	0.40	1.68	2.50	1.64	112				
	12.0000	495.300	19.5000	168.595	6.6376	127.000	5.0000		6.4	1.6	1 880	3 840		1	315	463	20.8	6.4	1.6	0.40	1.68	2.50	1.64	117				
	12.0000	495.300	19.5000	196.850	7.7500	146.050	5.7500		16	1.6	2 180	4 680		1	344	458	25.4	16	1.6	0.40	1.68	2.50	1.64	135				
	12.0000	495.300	19.5000	196.850	7.7500	146.050	5.7500		16	1.6	2 180	4 680		1	344	458	25.4	16	1.6	0.40	1.68	2.50	1.64	135				
	12.0000	558.800	22.0000	298.450	11.7500	222.250	8.7500		1.2	1.6	4 040	8 000		1-P	315	515	38.1	1.2	1.6	0.40	1.71	2.54	1.67	293				

[Notes] 1) While metric series bearings have minus tolerances for bore and OD, inch series have plus tolerances. Refer to page 190 for details of applicable tolerance standards.

2) SP indicates the specially chamfered form.

# Double-row tapered roller bearings

TDO, TDOS type

*d* 310 ~ (340) mm

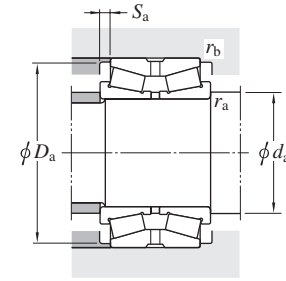
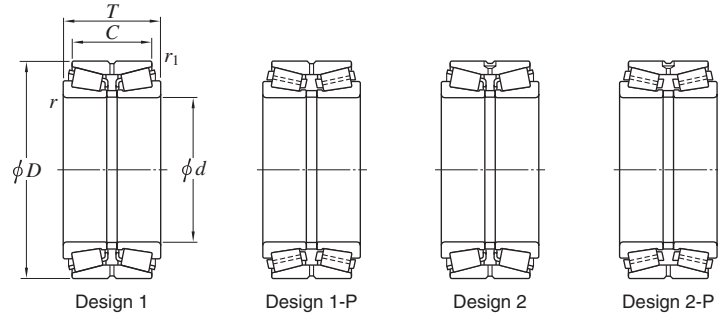

Boundary dimensions					Basic load ratings (kN)		Design	Mounting dimensions (mm)					Constant <i>e</i>	Axial load factors			(Refer.) Mass (kg)
<i>d</i>	<i>D</i>	<i>T</i>	<i>C</i>	<i>r</i> <sup>2)</sup>	<i>r</i> <sub>1</sub>	<i>C<sub>r</sub></i>		<i>C<sub>0r</sub></i>	<i>d<sub>a</sub></i>	<i>D<sub>a</sub></i>	<i>S<sub>a</sub></i>	<i>r<sub>a</sub></i>		<i>r<sub>b</sub></i>	<i>Y<sub>2</sub></i>	<i>Y<sub>3</sub></i>	
mm	mm	mm	mm	min.	min.			min.	min.	min.	max.	max.					
310	470	200	149	SP	1.5	2 180	4 810	336	445	25.5	5	1.5	0.38	1.76	2.62	1.72	113
311.150	558.800	190.500	111.125	9.5	3.2	1 880	3 490	338	505	39.7	9.5	3.2	0.88	0.77	1.15	0.75	171
317.500	444.500	146.050	98.425	7.9	1.6	1 240	2 760	341	414	23.8	7.9	1.6	0.38	1.79	2.66	1.75	58.9
	447.675	180.975	146.050	3.6	1.6	1 920	4 770	328	428	17.5	3.6	1.6	0.33	2.02	3.00	1.97	83.0
317.5	558.8	254	174	6	1.5	3 100	6 050	345.5	538	40	5	1.5	0.81	0.83	1.23	0.81	231
317.500	622.300	304.800	174.625	14.3	3.2	3 810	6 990	354	585	65.1	14.3	3.2	0.94	0.72	1.07	0.70	378
320	480	121	108	5	1.5	1 430	2 700	342	452	6.5	4	1.5	0.32	2.12	3.15	2.07	71.6
	480	151	121	5	1.5	1 650	3 410	342	454	15	4	1.5	0.32	2.12	3.15	2.07	87.7
	480	215	163	5	1.5	2 590	5 610	342	460	26	4	1.5	0.46	1.47	2.19	1.44	123
	540	176	157	6	2	2 440	4 570	348	502	9.5	5	2	0.35	1.95	2.90	1.91	154
	540	220	176	6	2	2 610	5 390	348	497	22	5	2	0.35	1.95	2.90	1.91	190
	550	240	180	5	2.5	3 300	6 420	342	514	30	4	2	0.40	1.68	2.50	1.64	221
329.870	533.400	165.100	114.300	4.8	1.6	1 870	3 580	346.5	494	25.4	4.8	1.6	0.33	2.03	3.02	1.98	124
	546.100	177.800	152.400	4.8	3.2	1 870	3 580	347	500	12.7	4.8	3.2	0.33	2.03	3.02	1.98	150
330	500	190	150	6	1.5	2 230	4 720	358	473	20	5	1.5	0.39	1.74	2.59	1.70	120
330.200	482.600	133.350	88.900	7.1	1.6	1 050	2 500	352	454	22.2	7.1	1.6	0.50	1.35	2.01	1.32	74.8
	482.600	177.800	127.000	6.4	1.6	1 850	4 100	350	454	25.4	6.4	1.6	0.39	1.73	2.57	1.69	96.4
	482.600	177.800	127.000	3.2	1.6	1 850	4 100	344	454	25.4	3.2	1.6	0.39	1.73	2.57	1.69	96.5
330.25	528	292	210	5	1.5	3 670	8 280	353	507	41	4	1.5	0.43	1.57	2.34	1.53	223
333.375	469.900	190.500	152.400	6.4	1.6	2 320	5 680	354	449	19.1	6.4	1.6	0.33	2.02	3.00	1.97	97.6
340	500	150	120	6	2	1 780	3 630	368	476	15	5	2	0.42	1.62	2.42	1.59	91.4
	500	249.225	203.2	5	1	2 670	6 450	362	477	23	4	1	0.33	2.03	3.02	1.98	155
	520	133	118	6	2	1 550	3 070	368	489	7.5	5	2	0.32	2.12	3.15	2.07	95.3

[Notes] 1) While metric series bearings have minus tolerances for bore and OD, inch series have plus tolerances. Refer to page 190 for details of applicable tolerance standards.

2) SP indicates the specially chamfered form.

Double-row tapered roller bearings

TDO, TDOS type  
d (340) ~ 368.249 mm

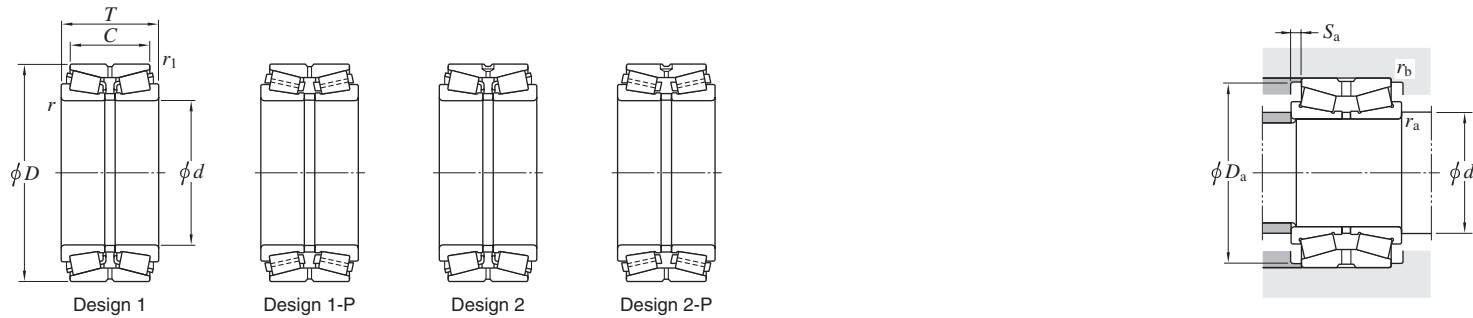

Boundary dimensions								Basic load ratings (kN)		Bearing No. 1)	Design	Mounting dimensions (mm)					Constant e	Axial load factors			(Refer.) Mass (kg)
d	D	T	C	r	r <sub>1</sub>	C <sub>r</sub>	C <sub>0r</sub>	d <sub>a</sub>	D <sub>a</sub>			S <sub>a</sub>	r <sub>a</sub>	r <sub>b</sub>	Y <sub>2</sub>	Y <sub>3</sub>		Y <sub>0</sub>			
mm	mm	mm	mm	mm	mm	mm	mm	min.	max.	min.	max.	min.	max.	min.	max.	min.	max.				
<b>340</b>	—	520	—	165	—	133	—	6	2	1 930	4 060	<b>46268A</b>		—	—	—	—	—	117		
	—	580	—	190	—	169	—	6	2	2 540	4 620	<b>46368</b>		—	—	—	—	198			
	—	580	—	238	—	190	—	6	2	3 160	6 340	<b>46368A</b>		—	—	—	—	244			
	—	580	—	241	—	170	—	6	1.5	3 480	6 890	<b>46T685824</b>		—	—	—	—	237			
	—	580	—	305	—	241	—	6	1.5	4 410	10 100	<b>46T685831C</b>		—	—	—	—	319			
<b>342.900</b>	13.5000	533.400	21.0000	165.100	6.5000	114.300	4.5000	4.8	1.6	1 870	3 580	<b>EE971354/972102D</b>		—	—	—	—	115			
	13.5000	546.100	21.5000	177.800	7.0000	152.400	6.0000	4.8	3.2	1 870	3 580	<b>EE971354/972151D</b>		—	—	—	—	141			
<b>346.075</b>	13.6250	482.600	19.0000	133.350	5.2500	88.900	3.5000	7.1	1.6	1 050	2 500	<b>EE161363/161901D</b>		—	—	—	—	66.1			
	13.6250	488.950	19.2500	200.025	7.8750	158.750	6.2500	6.4	1.6	2 310	5 800	<b>HM262749/HM262710D</b>		—	—	—	—	111			
<b>349.250</b>	13.7500	514.350	20.2500	193.675	7.6250	152.400	6.0000	6.4	1.6	2 180	5 070	<b>EE333137/333203D</b>		—	—	—	—	126			
<b>355</b>	—	515	—	194	—	152.4	—	6.4	1.5	2 190	5 110	<b>46T715219C</b>		—	—	—	—	121			
<b>355.600</b>	14.0000	444.500	17.5000	136.525	5.3750	111.125	4.3750	3.6	1.6	1 110	3 450	<b>L163149/L163110D</b>		—	—	—	—	45.0			
	14.0000	482.600	19.0000	133.350	5.2500	88.900	3.5000	7.1	1.6	1 050	2 500	<b>EE161400/161901D</b>		—	—	—	—	60.7			
	14.0000	501.650	19.7500	155.575	6.1250	107.950	4.2500	6.4	1.6	1 350	3 280	<b>EE231400/231976D</b>		—	—	—	—	87.2			
	14.0000	514.350	20.2500	155.575	6.1250	107.950	4.2500	6.4	1.6	1 350	3 280	<b>EE231400/232026D</b>		—	—	—	—	95.7			
	14.0000	514.350	20.2500	193.675	7.6250	152.400	6.0000	6.4	1.6	2 180	5 070	<b>EE333140/333203D</b>		—	—	—	—	120			
<b>360</b>	—	540	—	134	—	120	—	6	2	1 660	3 290	<b>46272</b>		—	—	—	—	93.0			
	—	540	—	169	—	134	—	6	2	2 020	4 230	<b>46272A</b>		—	—	—	—	124			
	—	540	—	184	—	140	—	6	1.5	2 400	4 980	<b>46T725418</b>		—	—	—	—	131			
	—	590	—	320	—	260	—	6	1.5	4 920	11 500	<b>46T725932</b>		—	—	—	—	328			
	—	600	—	192	—	171	—	6	2	2 680	4 880	<b>46372</b>		—	—	—	—	206			
	—	600	—	240	—	192	—	6	2	3 660	7 230	<b>46372A</b>		—	—	—	—	254			
<b>368.249</b>	14.4980	523.875	20.6250	214.313	8.4375	169.863	6.6875	6.4	1.6	2 860	7 060	<b>46T745221</b>		—	—	—	—	138			
	14.4980	523.875	20.6250	214.313	8.4375	169.863	6.6875	6.4	1.6	2 730	6 780	<b>HM265049/HM265010D</b>		—	—	—	—	119			

[Note] 1) While metric series bearings have minus tolerances for bore and OD, inch series have plus tolerances. Refer to page 190 for details of applicable tolerance standards.

# Double-row tapered roller bearings

TDO, TDOS type

d 368.300 ~ (400) mm

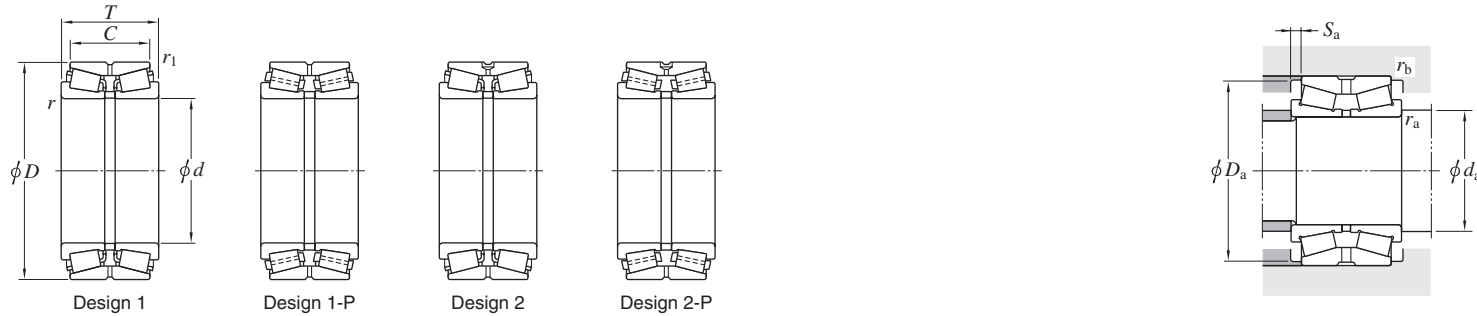

Boundary dimensions						Basic load ratings (kN)		Bearing No. <sup>1)</sup>	Design	Mounting dimensions (mm)					Constant e	Axial load factors			(Refer.) Mass (kg)
d mm	D mm	T mm	C mm	r <sup>2)</sup> min.	r <sub>1</sub> min.	C <sub>r</sub>	C <sub>Or</sub>			d <sub>a</sub> min.	D <sub>a</sub> min.	S <sub>a</sub> min.	r <sub>a</sub> max.	r <sub>b</sub> max.		Y <sub>2</sub>	Y <sub>3</sub>	Y <sub>0</sub>	
<b>368.300</b>	14.5000 596.900	23.5000 203.200	8.0000 133.350	5.2500 9.5	2.4 2.4	2 710	5 410	<b>EE181453/182351D</b>	1-P	395	555	34.9	9.5	2.4	0.41	1.63	2.42	1.59	203
<b>370</b>	— 680	— 280	— 188	— 6	2.5 2.5	3 890	8 610	<b>46T746828AC</b>	2-P	398	630	46	5	2	0.87	0.78	1.16	0.76	422
<b>371.475</b>	14.6250 501.650	19.7500 155.575	6.1250 107.950	4.2500 6.4	1.6 1.6	1 350	3 280	<b>EE231462/231976D</b>	1	392	481	23.8	6.4	1.6	0.44	1.53	2.28	1.50	76.2
	14.6250 514.350	20.2500 155.575	6.1250 107.950	4.2500 6.4	1.6 1.6	1 350	3 280	<b>EE231462/232026D</b>	1	392	481	23.8	6.4	1.6	0.44	1.53	2.28	1.50	84.7
<b>380</b>	— 520	— 149	— 112	— 5	1.5 1.5	1 740	3 990	<b>46T765215</b>	1	402	493	18.5	4	1.5	0.29	2.32	3.45	2.26	82
	— 560	— 135	— 122	— 6	2 2	1 740	3 560	<b>46276</b>	1	408	530	6.5	5	2	0.32	2.12	3.15	2.07	100
	— 560	— 171	— 135	— 6	2 2	2 240	4 670	<b>46276A</b>	1	408	531	18	5	2	0.39	1.74	2.59	1.70	129
	— 620	— 194	— 173	— 6	2 2	2 870	5 220	<b>46376</b>	1	408	582	10.5	5	2	0.39	1.74	2.59	1.70	215
	— 620	— 241	— 170	— 6	1.5 1.5	3 440	7 080	<b>46T766224</b>	1	408	575	35.5	5	1.5	0.46	1.47	2.19	1.44	255
	— 620	— 243	— 194	— 6	2 2	3 490	7 360	<b>46376A</b>	1	408	587	24.5	5	2	0.35	1.95	2.90	1.91	265
<b>381.000</b>	15.0000 508.000	20.0000 139.700	5.5000 88.900	3.5000 6.4	1.6 1.6	1 180	2 980	<b>EE192150/192201D</b>	1	401	480	25.4	6.4	1.6	0.53	1.27	1.89	1.24	66.7
	15.0000 546.100	21.5000 222.250	8.7500 177.800	7.0000 6.4	1.6 1.6	3 260	8 430	<b>HM266447/HM266410D</b>	1-P	401	520	22.2	6.4	1.6	0.33	2.03	3.02	1.98	166
	15.0000 590.550	23.2500 244.475	9.6250 193.675	7.6250 6.4	1.6 1.6	3 390	8 930	<b>M268730/M268710D</b>	1-P	401	565	25.4	6.4	1.6	0.33	2.03	3.02	1.98	244
<b>384.175</b>	15.1250 546.100	21.5000 222.250	8.7500 177.800	7.0000 6.4	1.6 1.6	3 260	8 430	<b>HM266449/HM266410D</b>	1-P	404	520	22.2	6.4	1.6	0.33	2.03	3.02	1.98	163
<b>385</b>	— 550	— 220	— 180	— SP	1.5 1.5	3 260	8 430	<b>46T775522</b>	1-P	408	524	20	4	1.5	0.33	2.03	3.02	1.98	170
<b>390</b>	— 630	— 254	— 170	— 6	1.5 1.5	3 460	7 490	<b>46T786325</b>	1-P	418	601	42	5	1.5	0.76	0.88	1.31	0.86	290
<b>393.700</b>	15.5000 539.750	21.2500 142.875	5.6250 101.600	4.0000 6.4	1.6 1.6	1 490	3 810	<b>EE234154/234213D</b>	1	414	515	20.6	6.4	1.6	0.48	1.42	2.11	1.39	89.0
	15.5000 546.100	21.5000 158.750	6.2500 117.475	4.6250 6.4	1.6 1.6	1 490	3 810	<b>EE234154/234216D</b>	1	414	515	20.6	6.4	1.6	0.48	1.42	2.11	1.39	102
<b>396.875</b>	15.6250 539.750	21.2500 142.875	5.6250 101.600	4.0000 6.4	1.6 1.6	1 490	3 810	<b>EE234156/234213D</b>	1	417	515	20.6	6.4	1.6	0.48	1.42	2.11	1.39	86.8
	15.6250 546.100	21.5000 158.750	6.2500 117.475	4.6250 6.4	1.6 1.6	1 490	3 810	<b>EE234156/234216D</b>	1	417	515	20.6	6.4	1.6	0.48	1.42	2.11	1.39	100
<b>400</b>	— 540	— 140	— 100	— 6	1.5 1.5	1 490	3 840	<b>46T805414</b>	1	428	510	20	5	1.5	0.48	1.42	2.11	1.39	81.8
	— 600	— 148	— 132	— 6	2 2	1 870	3 720	<b>46280</b>	1	428	560	8	5	2	0.32	2.12	3.15	2.07	135
	— 600	— 185	— 148	— 6	2 2	2 420	5 150	<b>46280A</b>	1	428	563	18.5	5	2	0.32	2.12	3.15	2.07	167

[Notes] 1) While metric series bearings have minus tolerances for bore and OD, inch series have plus tolerances. Refer to page 190 for details of applicable tolerance standards.

2) SP indicates the specially chamfered form.

# Double-row tapered roller bearings

## TDO, TDOS type

*d* (400) ~ (431.800) mm

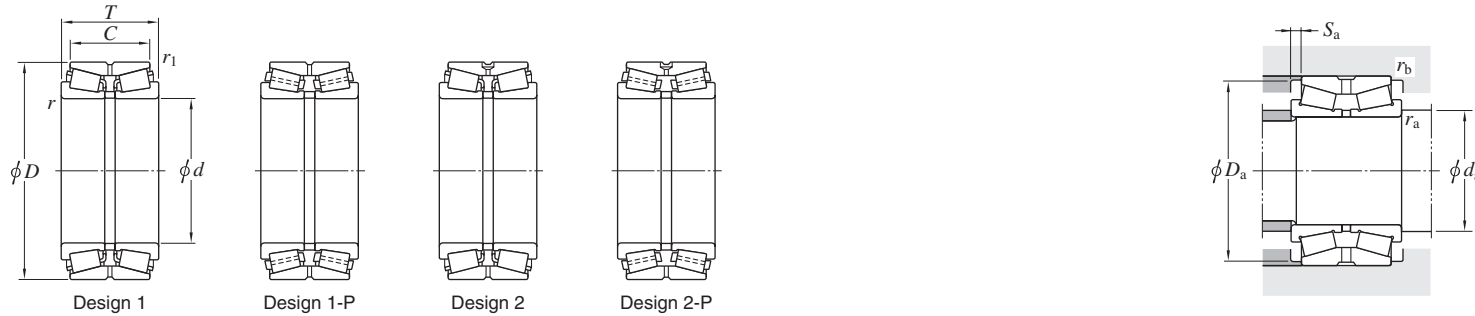

Boundary dimensions								Basic load ratings (kN)		Bearing No. 1)	Design	Mounting dimensions (mm)					Constant e	Axial load factors			Mass (kg)
d	D	T	C	r <sup>2)</sup>	r <sub>1</sub> <sup>2)</sup>	C <sub>r</sub>	C <sub>0r</sub>	d <sub>a</sub>	D <sub>a</sub>			S <sub>a</sub>	r <sub>a</sub>	r <sub>b</sub>	Y <sub>2</sub>	Y <sub>3</sub>		Y <sub>0</sub>			
mm	1/25.4	mm	1/25.4	mm	1/25.4	mm	1/25.4	min.	min.		min.	min.	min.	max.	max.						
400	—	600	—	205	—	150	—	6	1.5	2 830	6 270	<b>46T806021</b>					0.40	1.68	2.50	1.64	187
	—	650	—	200	—	178	—	6	3	2 980	5 920	<b>46380</b>					0.35	1.95	2.90	1.91	243
	—	650	—	250	—	200	—	6	3	4 060	8 850	<b>46380A</b>					0.35	1.95	2.90	1.91	306
	—	650	—	280	—	180	—	6	2.5	3 890	8 610	<b>46T806528AC</b>					0.87	0.78	1.16	0.76	335
406.400	16.0000	539.750	21.2500	142.875	5.6250	101.600	4.0000	6.4	1.6	1 490	3 810	<b>EE234160/234213D</b>					0.48	1.42	2.11	1.39	80.2
	16.0000	546.100	21.5000	158.750	6.2500	117.475	4.6250	6.4	1.6	1 490	3 810	<b>EE234160/234216D</b>					0.48	1.42	2.11	1.39	92.6
	16.0000	574.675	22.6250	157.163	6.1875	106.363	4.1875	6.7	1.6	1 630	3 880	<b>EE285160/285228D</b>					0.50	1.35	2.01	1.32	113
	16.0000	574.675	22.6250	175.000	6.8898	118.000	4.6457	SP	SP	2 030	4 620	<b>46T815718</b>					0.70	0.97	1.44	0.94	126
	16.0000	590.550	23.2500	228.600	9.0000	174.625	6.8750	9.5	1.6	3 060	7 070	<b>EE833160X/833233D</b>					0.32	2.08	3.10	2.04	188
	16.0000	609.524	23.9970	177.800	7.0000	133.350	5.2500	7.9	1.6	2 600	6 060	<b>EE736160/736239D</b>					0.35	1.95	2.90	1.91	164
	16.0000	609.600	24.0000	187.325	7.3750	123.825	4.8750	6.7	1.6	2 440	5 280	<b>EE911600/912401D</b>					0.38	1.76	2.62	1.72	167
	16.0000	673.100	26.5000	192.639	7.5842	127.000	5.0000	6.4	1.6	2 530	5 240	<b>EE571602/572651D</b>					0.40	1.68	2.50	1.64	232
	16.0000	673.100	26.5000	192.639	7.5842	152.400	6.0000	6.4	1.6	2 530	5 240	<b>EE571602/572653D</b>					0.40	1.68	2.50	1.64	242
409.575	16.1250	546.100	21.5000	185.738	7.3125	147.638	5.8125	6.4	1.6	2 280	5 740	<b>M667948/M667911D</b>					0.42	1.62	2.42	1.59	110
415.925	16.3750	590.550	23.2500	244.475	9.6250	193.675	7.6250	6.4	1.6	3 390	8 930	<b>M268749/M268710D</b>					0.33	2.03	3.02	1.98	203
420	—	620	—	150	—	134	—	6	2	2 010	4 130	<b>46284</b>					0.33	2.03	3.02	1.98	142
	—	620	—	188	—	150	—	6	2	2 700	5 660	<b>46284A</b>					0.39	1.74	2.59	1.70	176
	—	620	—	190	—	125	—	6	1.5	2 060	4 380	<b>46T846219</b>					0.35	1.95	2.91	1.91	184
	—	622.3	—	240	—	135	—	7.5	1.5	2 700	5 920	<b>46T846224</b>					0.87	0.78	1.16	0.76	214
	—	700	—	224	—	200	—	6	3	3 700	6 880	<b>46384</b>					0.39	1.74	2.59	1.70	325
	—	700	—	274	—	200	—	6	2.5	4 820	9 570	<b>46T847027</b>					0.32	2.12	3.15	2.07	386
	—	700	—	280	—	224	—	6	3	4 810	9 620	<b>46384A</b>					0.39	1.74	2.59	1.70	400
	430.213	16.9375	603.250	23.7500	159.639	6.2850	104.775	4.1250	6.4	1.6	1 680	3 770	<b>EE241693/242377D</b>					0.53	1.28	1.91	1.26
431.800	17.0000	571.500	22.5000	155.575	6.1250	111.125	4.3750	3.2	1.6	1 680	4 270	<b>LM869448/LM869410D</b>					0.55	1.24	1.84	1.21	97.3
	17.0000	603.250	23.7500	159.639	6.2850	104.775	4.1250	6.4	1.6	1 680	3 770	<b>EE241701/242377D</b>					0.53	1.28	1.91	1.26	112

[Notes] 1) While metric series bearings have minus tolerances for bore and OD, inch series have plus tolerances. Refer to page 190 for details of applicable tolerance standards.

2) SP indicates the specially chamfered form.



# Double-row tapered roller bearings

## TDO, TDOS type

$d$  (431.800) ~ 482.600 mm

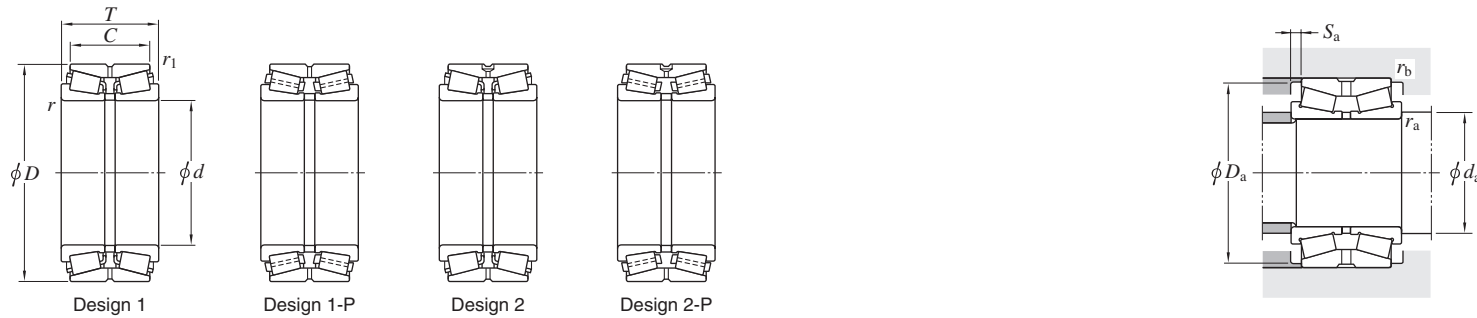

Boundary dimensions								Basic load ratings (kN)		Bearing No. 1)	Design	Mounting dimensions (mm)					Constant $e$	Axial load factors			(Refer.) Mass (kg)		
$d$ mm	$D$ mm	$T$ mm	$C$ mm	$r^{2)}$ min.	$r_1^{2)}$ min.	$C_r$	$C_{Or}$	$d_a$ min.	$D_a$ min.			$S_a$ min.	$r_a$ max.	$r_b$ max.	$e$	$Y_2$		$Y_3$	$Y_0$				
431.800	17.0000	673.100	26.5000	192.639	7.5842	127.000	5.0000	6.4	1.6	2 530	5 240	<b>EE571703/572651D</b>	1	453	620	32.8	6.4	1.6	0.40	1.68	2.50	1.64	207
	17.0000	673.100	26.5000	192.639	7.5842	152.400	6.0000	6.4	1.6	2 530	5 240	<b>EE571703/572653D</b>	1	453	630	20.1	6.4	1.6	0.40	1.68	2.50	1.64	217
440	—	650	—	157	—	140	—	6	3	2 260	4 430	<b>46288</b>	1	468	622	8.5	5	2.5	0.33	2.03	3.02	1.98	156
	—	650	—	196	—	157	—	6	3	3 000	6 370	<b>46288A</b>	1	468	620	19.5	5	2.5	0.39	1.74	2.59	1.70	198
	—	720	—	283	—	226	—	6	3	4 940	10 100	<b>46388A</b>	1-P	468	679	28.5	5	2.5	0.40	1.68	2.51	1.65	418
441.325	17.3750	660.400	26.0000	195.263	7.6875	138.113	5.4375	10.4	1.6	2 320	5 260	<b>EE737173/737261D</b>	1	471	615	28.6	10.4	1.6	0.37	1.80	2.69	1.76	207
447.675	17.6250	635.000	25.0000	257.175	10.1250	206.375	8.1250	6.4	1.6	3 930	10 500	<b>M270749/M270710D</b>	1-P	469	605	25.4	6.4	1.6	0.33	2.03	3.02	1.98	247
457.200	18.0000	596.900	23.5000	165.100	6.5000	120.650	4.7500	9.5	1.6	1 920	5 230	<b>EE244180/244236D</b>	1	485	570	22.2	9.5	1.6	0.40	1.67	2.48	1.63	108
	18.0000	605.000	23.8190	165.100	6.5000	120.650	4.7500	SP	SP	1 920	5 230	<b>46T916117</b>	2-P	489	575	22	6	0.8	0.40	1.67	2.48	1.63	130
460	—	680	—	163	—	145	—	6	3	2 500	5 340	<b>46292</b>	1-P	488	637	9	5	2.5	0.37	1.83	2.72	1.78	196
	—	680	—	204	—	163	—	6	3	3 220	6 850	<b>46292A</b>	1-P	488	646	20.5	5	2.5	0.39	1.74	2.59	1.70	232
	—	680	—	229	—	175	—	6	2.5	3 430	7 390	<b>46T926823</b>	1	488	645	27	5	2	0.32	2.12	3.15	2.07	251
	—	760	—	240	—	214	—	7.5	4	4 580	9 000	<b>46392</b>	1-P	496	710	13	6	3	0.39	1.74	2.59	1.70	424
	—	760	—	300	—	240	—	7.5	4	5 680	11 600	<b>46392A</b>	1-P	496	718	30	6	3	0.39	1.74	2.59	1.70	506
479.425	18.8750	679.450	26.7500	276.225	10.8750	222.250	8.7500	6.4	1.6	4 740	12 700	<b>46T966828</b>	2-P	490	649	27	6.4	1.6	0.33	2.03	3.02	1.98	309
	18.8750	679.450	26.7500	276.225	10.8750	222.250	8.7500	6.4	1.6	4 240	11 100	<b>M272749/M272710D</b>	1-P	500	650	27	6.4	1.6	0.33	2.03	3.02	1.98	296
480	—	615	—	120	—	94	—	3	1	1 460	3 620	<b>46T966212</b>	1	494	590	13	2.5	1	0.35	1.95	2.90	1.91	80.1
	—	700	—	165	—	147	—	6	3	2 530	5 300	<b>46296</b>	1	508	672	9	5	2.5	0.33	2.03	3.02	1.98	186
	—	700	—	206	—	165	—	6	3	3 220	7 230	<b>46296A</b>	1	508	666	20.5	5	2.5	0.33	2.03	3.02	1.98	240
	—	700	—	275	—	200	—	6	3	4 320	10 300	<b>46T967028</b>	1-P	508	676	37	5	2.5	0.55	1.24	1.84	1.21	350
	—	790	—	248	—	221	—	7.5	4	4 640	8 920	<b>46396</b>	1-P	516	742	13.5	6	3	0.39	1.74	2.59	1.70	457
	—	790	—	310	—	248	—	7.5	4	5 990	12 400	<b>46396A</b>	1-P	516	749	31	6	3	0.39	1.74	2.59	1.70	560
	—	790	—	310	—	248	—	7.5	4	5 990	12 400	<b>46396A</b>	1-P	516	749	31	6	3	0.39	1.74	2.59	1.70	560
482.600	19.0000	615.950	24.2500	184.150	7.2500	146.050	5.7500	6.4	1.6	2 420	7 110	<b>LM272249/LM272210D</b>	1	505	595	19.1	6.4	1.6	0.33	2.03	3.02	1.98	125
	19.0000	634.873	24.9950	177.800	7.0000	142.875	5.6250	6.4	1.6	2 260	6 590	<b>EE243190/243251D</b>	1	505	610	17.5	6.4	1.6	0.34	1.97	2.93	1.93	143

[Notes] 1) While metric series bearings have minus tolerances for bore and OD, inch series have plus tolerances. Refer to page 190 for details of applicable tolerance standards.

2) SP indicates the specially chamfered form.

# Double-row tapered roller bearings

TDO, TDOS type

*d* 488.671 ~ 546.100 mm

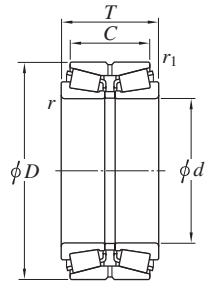

Design 1



Design 1-P



Design 2



Design 2-P

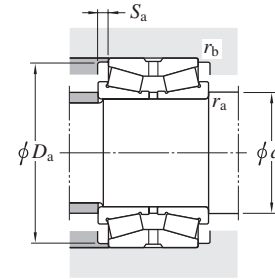

Boundary dimensions						Basic load ratings (kN)		Bearing No. <sup>1)</sup>	Design	Mounting dimensions (mm)					Constant <i>e</i>	Axial load factors			(Refer.) Mass (kg)
<i>d</i> mm	<i>D</i> mm	<i>T</i> mm	<i>C</i> mm	<i>r</i> min.	<i>r</i> <sub>1</sub> min.	<i>C</i> <sub>r</sub>	<i>C</i> <sub>0r</sub>			<i>d</i> <sub>a</sub> min.	<i>D</i> <sub>a</sub> min.	<i>S</i> <sub>a</sub> min.	<i>r</i> <sub>a</sub> max.	<i>r</i> <sub>b</sub> max.		<i>e</i>	<i>Y</i> <sub>2</sub>	<i>Y</i> <sub>3</sub>	
488.671	660.400	206.375	158.750	6.4	1.6	3 100	7 910	EE640191/640261D	1-P	510	630	23.8	6.4	1.6	0.31	2.20	3.27	2.15	186
488.950	634.873	180.975	136.525	6.4	1.6	2 460	6 840	LM772748/LM772710D	1	510	615	22.2	6.4	1.6	0.47	1.43	2.12	1.40	135
	660.400	206.375	158.750	6.4	1.6	3 100	7 910	EE640192/640261D	1-P	510	630	23.8	6.4	1.6	0.31	2.20	3.27	2.15	186
489.026	634.873	177.800	142.875	6.4	1.6	2 260	6 590	EE243192/243251D	1	510	610	17.5	6.4	1.6	0.34	1.97	2.93	1.93	136
490	640	179	144	7.5	2	2 430	6 480	46T986418	1	526	615	17.5	6	2	0.37	1.80	2.69	1.76	139
498.475	634.873	177.800	142.875	6.4	1.6	2 260	6 590	EE243196/243251D	1	520	610	17.5	6.4	1.6	0.34	1.97	2.93	1.93	126
500	720	167	149	6	3	2 580	5 690	462/500	1-P	528	679	9	5	2.5	0.40	1.71	2.54	1.67	210
	720	209	167	6	3	3 500	7 850	462/500A	1-P	528	690	21	5	2.5	0.42	1.62	2.41	1.58	258
	830	264	235	7.5	4	5 220	10 900	463/500	1-P	536	776	14.5	6	3	0.39	1.74	2.59	1.70	559
	830	330	264	7.5	4	6 780	14 000	463/500A	1-P	536	784	33	6	3	0.39	1.74	2.59	1.70	669
506	636	187	147	7	2	2 400	7 110	2TR506	1	542	620	20	6	2	0.35	1.95	2.90	1.91	126
508.000	736.600	186.502	114.300	6.4	1.6	2 520	5 150	EE982003/982901D	1-P	530	690	36.1	6.4	1.6	0.48	1.42	2.11	1.39	220
515	720	140	180	6	3	2 840	6 550	2TR515C3	1-P	540	682	20	5	2.5	0.39	1.74	2.59	1.70	204
520.700	736.600	186.502	114.300	6.4	1.6	2 520	5 150	EE982051/982901D	1-P	545	690	36.1	6.4	1.6	0.48	1.42	2.11	1.39	205
530	780	185	163	6	3	3 050	6 860	2TR530D	2-P	550	732	11	5	2.5	0.47	1.43	2.12	1.40	283
	780	185	163	6	3	3 430	7 070	462/530	1-P	558	744	11	5	2.5	0.39	1.74	2.59	1.70	280
	780	231	185	6	3	4 390	9 980	462/530A	1-P	558	746	23	5	2.5	0.39	1.74	2.59	1.70	351
533.400	812.800	269.875	187.325	9.5	3.2	4 530	11 000	EE626210/626321D	1-P	565	760	41.3	9.5	3.2	0.44	1.54	2.29	1.50	459
536.575	761.873	311.15	247.65	6.4	1.6	5 630	14 400	M276449/10CD	2-P	555	726	32	6.4	1.6	0.33	2.03	3.02	1.98	424
546.100	736.600	165.100	114.300	6.4	3.2	2 420	6 100	EE542215/542291D	1-P	570	705	25.4	6.4	3.2	0.51	1.33	1.97	1.30	181

[Note] 1) While metric series bearings have minus tolerances for bore and OD, inch series have plus tolerances. Refer to page 190 for details of applicable tolerance standards.

# Double-row tapered roller bearings

## TDO, TDOS type

$d$  558.800 ~ (609.600) mm

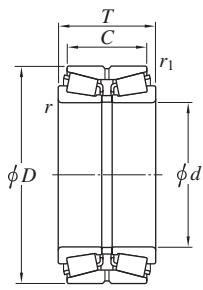

Design 1

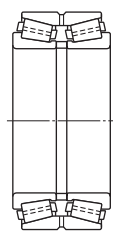

Design 1-P

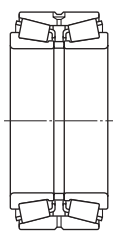

Design 2

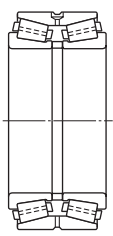

Design 2-P

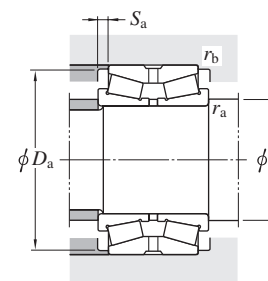

Boundary dimensions								Basic load ratings (kN)		Bearing No. <sup>1)</sup>	Design	Mounting dimensions (mm)					Constant $e$	Axial load factors			(Refer.) Mass (kg)		
$d$ mm	$D$ mm	$T$ mm	$C$ mm	$r^{2)}$ min.	$r_1^{2)}$ min.	$C_r$	$C_{Or}$	$d_a$ min.	$D_a$ min.			$S_a$ min.	$r_a$ max.	$r_b$ max.	$e$	$Y_2$		$Y_3$	$Y_0$				
558.800	22.0000	736.600	29.0000	165.100	6.5000	114.300	4.5000	6.4	3.2	2 420	6 100	<b>EE542220/542291D</b>	1-P	580	705	25.4	6.4	3.2	0.51	1.33	1.97	1.30	167
	22.0000	736.600	29.0000	187.328	7.3751	138.113	5.4375	6.4	1.6	2 960	8 050	<b>EE843220/843291D</b>	1-P	580	710	24.6	6.4	1.6	0.34	1.97	2.93	1.93	198
	22.0000	736.600	29.0000	225.425	8.8750	160	6.2992	6.4	1.6	3 220	9 180	<b>2TR559</b>	1-P	580	720	32.7	6.4	1.6	0.70	0.97	1.44	0.94	239
	22.0000	736.600	29.0000	225.425	8.8750	177.800	7.0000	6.4	1.6	3 590	9 870	<b>LM377449/LM377410D</b>	1-P	580	710	23.8	6.4	1.6	0.35	1.95	2.90	1.91	240
	22.0000	742.950	29.2500	187.328	7.3751	138.113	5.4375	6.4	1.6	2 960	8 050	<b>EE843220/843292D</b>	1-P	580	710	24.6	6.4	1.6	0.34	1.97	2.93	1.93	206
560	—	735	—	225	—	180	—	6	1.5	3 590	9 870	<b>46T117423</b>	2-P	588	710	22.5	5	1.5	0.35	1.95	2.90	1.91	236
560.000	22.0472	740.000	29.1339	190.000	7.4803	140.000	5.5118	SP	SP	2 960	8 050	<b>2TR560B</b>	1-P	585	715	25	4	0.8	0.34	1.97	2.93	1.93	220
560	—	820	—	195	—	173	—	6	3	3 420	7 940	<b>2TR560L</b>	2-P	595	768	11	5	2.5	0.39	1.74	2.59	1.70	336
	—	820	—	195	—	173	—	6	3	3 710	7 990	<b>462/560</b>	1-P	588	779	11	5	2.5	0.39	1.74	2.59	1.70	330
	—	820	—	244	—	195	—	6	3	4 760	11 000	<b>462/560A</b>	1-P	588	774	24.5	5	2.5	0.33	2.03	3.02	1.98	410
	—	920	—	280	—	246	—	7.5	4	5 990	11 700	<b>463/560</b>	1-P	596	863	17	6	3	0.39	1.74	2.59	1.70	694
	—	920	—	350	—	280	—	7.5	4	7 830	16 400	<b>463/560A</b>	1-P	596	869	35	6	3	0.39	1.74	2.59	1.70	856
571.500	22.5000	812.800	32.0000	333.375	13.1250	263.525	10.3750	6.4	1.6	6 510	17 500	<b>M278749/10D</b>	1-P	600	778	35	6.4	1.6	0.33	2.03	3.02	1.98	526
580	—	800	—	300	—	235	—	7	3	5 760	15 400	<b>2TR580A</b>	1-P	608	768	32.5	6	2.5	0.33	2.03	3.02	1.98	425
590	—	990	—	400	—	270	—	7.5	2.5	8 880	19 000	<b>2TR590</b>	1-P	626	940	65	6	2	0.70	0.97	1.44	0.94	1 140
600	—	870	—	200	—	176	—	6	3	3 930	8 290	<b>462/600</b>	1-P	628	833	12	5	2.5	0.39	1.74	2.59	1.70	369
	—	870	—	250	—	200	—	6	3	5 330	12 600	<b>462/600A</b>	1-P	628	826	25	5	2.5	0.33	2.03	3.02	1.98	466
	—	870	—	269	—	198	—	6	2.5	5 650	13 500	<b>2TR600J</b>	1-P	628	830	35.5	5	2	0.40	1.68	2.50	1.64	494
	—	980	—	300	—	264	—	7.5	4	6 950	13 900	<b>463/600</b>	1-P	636	920	18	6	3	0.37	1.80	2.69	1.76	850
602.945	23.7380	787.400	31.0000	206.375	8.1250	158.750	6.2500	6.4	1.6	3 390	9 940	<b>EE649237/649311D</b>	1-P	625	755	23.8	6.4	1.6	0.37	1.82	2.70	1.78	252
	23.7380	793.750	31.2500	206.375	8.1250	158.750	6.2500	6.4	1.6	3 390	9 940	<b>EE649237/649313D</b>	1-P	625	755	23.8	6.4	1.6	0.37	1.82	2.70	1.78	261
609.600	24.0000	787.400	31.0000	206.375	8.1250	158.750	6.2500	6.4	1.6	3 390	9 940	<b>EE649240/649311D</b>	1-P	635	755	23.8	6.4	1.6	0.37	1.82	2.70	1.78	241
	24.0000	793.750	31.2500	206.375	8.1250	158.750	6.2500	6.4	1.6	3 390	9 940	<b>EE649240/649313D</b>	1-P	635	755	23.8	6.4	1.6	0.37	1.82	2.70	1.78	251

[Notes] 1) While metric series bearings have minus tolerances for bore and OD, inch series have plus tolerances. Refer to page 190 for details of applicable tolerance standards.

2) SP indicates the specially chamfered form.

Double-row tapered roller bearings

TDO, TDOS type

d (609.600) ~ (850) mm

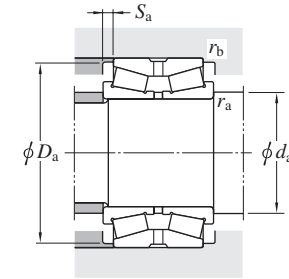
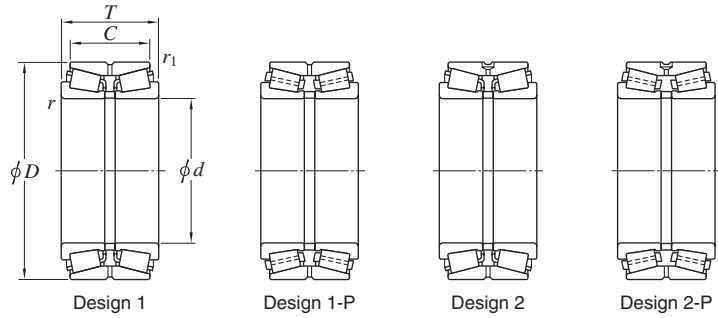

Boundary dimensions						Basic load ratings (kN)		Bearing No. <sup>1)</sup>	Design	Mounting dimensions (mm)					Constant e	Axial load factors			(Refer.) Mass (kg)
d	D	T	C	r <sup>2)</sup>	r <sub>1</sub> <sup>2)</sup>	C <sub>r</sub>	C <sub>Or</sub>			d <sub>a</sub>	D <sub>a</sub>	S <sub>a</sub>	r <sub>a</sub>	r <sub>b</sub>		Y <sub>2</sub>	Y <sub>3</sub>	Y <sub>0</sub>	
mm	mm	mm	mm	mm	mm			min.	min.	min.	max.	max.							
609.600	812.800	190.500	146.050	6.4	3.2	3 280	8 590	EE743240/743321D	1-P	635	770	22.2	6.4	3.2	0.33	2.06	3.06	2.01	250
630	800	180	140	6	2	2 960	8 310	2TR630	1-P	658	775	20	5	2	0.37	1.80	2.69	1.76	210
	920	212	186	7.5	4	4 490	9 550	462/630	1-P	666	878	13	6	3	0.39	1.74	2.59	1.70	446
	920	265	212	7.5	4	5 870	13 800	462/630A	1-P	666	874	26.5	6	3	0.33	2.03	3.02	1.98	556
	1 030	389	315	7.5	4	9 750	21 600	463/630A	1-P	666	978	37	6	3	0.39	1.74	2.59	1.70	1 210
670	880	185	130	6	2	3 310	8 780	2TR670A	1-P	700	843	27.5	5	2	0.45	1.50	2.23	1.46	270
	980	230	202	7.5	4	4 860	11 500	462/670	1-P	706	931	14	6	3	0.39	1.74	2.59	1.70	568
	980	288	230	7.5	4	6 700	15 900	462/670A	1-P	706	938	29	6	3	0.39	1.74	2.59	1.70	689
682.625	965.200	396.875	311.15	9.5	1.6	9 150	25 400	2TR683-1	2-P	710	926	42.8	9.5	1.6	0.33	2.03	3.02	1.98	886
685.800	876.300	200.025	152.400	6.4	1.6	3 510	10 800	EE655270/655346D	1-P	710	850	23.8	6.4	1.6	0.42	1.62	2.42	1.59	280
710	1 030	236	208	7.5	4	5 250	12 300	462/710	1-P	746	968	14	6	3	0.39	1.74	2.59	1.70	623
	1 030	295	236	7.5	4	7 130	16 600	462/710A	1-P	746	983	29.5	6	3	0.37	1.80	2.69	1.76	748
	1 150	393	345	9.5	5	11 100	24 600	463/710A	1-P	754	1 098	24	8	4	0.39	1.74	2.59	1.70	1 530
711.200	914.400	190.500	139.700	6.4	1.6	3 020	8 930	EE755280/755361D	1-P	735	880	25.4	6.4	1.6	0.38	1.78	2.65	1.74	290
723.900	914.400	187.325	139.700	3.2	1.6	3 020	8 930	EE755285/755361D	1-P	745	880	23.8	3.2	1.6	0.38	1.78	2.65	1.74	266
749.300	990.600	338.000	265.000	6.4	3.2	7 850	23 900	LM283649/LM283610D	1-P	775	960	36.5	6.4	3.2	0.32	2.12	3.15	2.07	681
780	1 150	330	210	7.5	2.5	7 600	18 500	2TR780	1-P	816	1 090	60	6	2	0.70	0.97	1.44	0.94	1 050
800	1 150	258	227	7.5	4	6 420	15 500	462/800	1-P	836	1 104	15.5	6	3	0.39	1.74	2.59	1.70	845
	1 150	323	258	7.5	4	8 580	21 100	462/800A	1-P	836	1 098	32.5	6	3	0.33	2.03	3.02	1.98	1 020
812.800	1 016.000	190.500	146.050	6.4	1.6	3 730	10 500	EE762320/762401D	1-P	840	980	22.2	6.4	1.6	0.43	1.59	2.36	1.55	321
850	1 120	266	190	6	2.5	6 340	17 100	2TR850D	1-P	878	1 080	38	5	2	0.46	1.47	2.19	1.44	641

[Notes] 1) While metric series bearings have minus tolerances for bore and OD, inch series have plus tolerances. Refer to page 190 for details of applicable tolerance standards.

2) SP indicates the specially chamfered form.

# Double-row tapered roller bearings

TDO, TDOS type

$d$  (850) ~ 1 450 mm

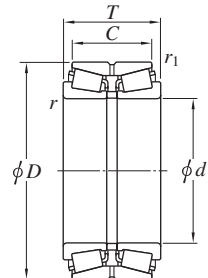

Design 1



Design 1-P

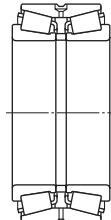

Design 2



Design 2-P

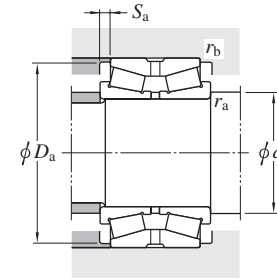

Boundary dimensions								Basic load ratings (kN)		Bearing No. <sup>1)</sup>	Design	Mounting dimensions (mm)					Constant $e$	Axial load factors			(Refer.) Mass (kg)									
$d$ mm	$D$ mm	$T$ mm	$C$ mm	$r_1^{2)}$ min.	$r_1^{2)}$ min.	$C_r$	$C_{0r}$	$d_a$ min.	$D_a$ min.			$S_a$ min.	$r_a$ max.	$r_b^{2)}$ max.	$e$	$Y_2$		$Y_3$	$Y_0$											
850	—	1 360	—	400	—	352	—	12	SP	12 400	27 300	463/850	1-P	904	1 284	24	10	SP	0.39	1.74	2.59	1.70	2 170							
	—	1 360	—	500	—	400	—	12	SP	16 000	37 700			463/850A	1-P	904	1 287	50						10	SP	0.39	1.74	2.59	1.70	2 710
950	—	1 250	—	272	—	174	—	SP	3	6 270	17 500	2TR950B	1-P	986	1 200	49	12	2.5	0.73	0.92	1.37	0.90	786							
	—	1 250	—	298	—	220	—	7.5	3	7 660	21 900			2TR950	1-P	986	1 190	39						6	2.5	0.33	2.03	3.02	1.98	896
	—	1 280	—	280	—	246	—	7.5	4	7 740	20 600			2TR950J	1-P	986	1 220	17						6	3	0.33	2.03	3.02	1.98	986
1 270.000	50.0000	1 435.100	56.5000	146.050	5.7500	101.600	4.0000	6.4	3.2	2 920	11 800	LL889049/LL889010D	1	1 300	1 410	22.2	6.4	3.2	0.57	1.18	1.76	1.16	296							
1 370	—	1 605	—	210	—	150	—	7.5	4	5 240	18 900	2TR1370B	1-P	1 406	1 560	30	6	3	0.55	1.24	1.84	1.21	660							
1 450	—	1 770	—	290	—	170	—	6	2.5	7 700	25 200	2TR1450	1-P	1 486	1 703	60	5	2	0.61	1.11	1.66	1.09	1 260							

[Notes] 1) While metric series bearings have minus tolerances for bore and OD, inch series have plus tolerances. Refer to page 190 for details of applicable tolerance standards.

2) SP indicates the specially chamfered form.

# Double-row tapered roller bearings

## TNA type

d 101.600 ~ 174.625 mm

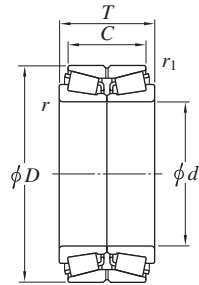

Design 1



Design 2

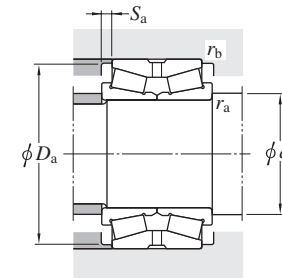

Boundary dimensions						Basic load ratings (kN)		Bearing No. <sup>1)</sup>	Design	Mounting dimensions (mm)					Constant e	Axial load factors			Mass (kg)						
d	D	T	C	r	r <sub>1</sub>	C <sub>r</sub>	C <sub>0r</sub>			d <sub>a</sub>	D <sub>a</sub>	S <sub>a</sub>	r <sub>a</sub>	r <sub>b</sub>		Y <sub>2</sub>	Y <sub>3</sub>	Y <sub>0</sub>							
mm	mm	mm	mm	mm	mm			min.	min.	min.	max.	max.													
101.600	168.275	92.075	69.850	3.6	0.8	385	698	4.0000	1/25.4	6.6250	2.7500			NA691/672D	2	120	156	11.2	3.6	0.8	0.47	1.43	2.14	1.40	7.36
104.775	180.975	104.775	85.725	3.6	1.6	494	876	4.1250	1/25.4	7.1250	3.3750			NA782/774D	2	123	165	9.6	3.6	1.6	0.39	1.75	2.61	1.71	10.5
114.300	190.500	106.363	80.963	3.6	1.6	520	965	4.5000	7.5000	4.1875	3.1875			NA71450/751D	2	133	177	12.7	3.6	1.6	0.42	1.62	2.42	1.59	11.0
	212.725	142.875	117.475	3.6	1.6	771	1350	4.5000	8.3750	5.6250	4.6250			NA938//932D	1	133	192	12.7	3.6	1.6	0.33	2.07	3.09	2.03	21.2
115	210	143	118	4	1.5	880	1400	—	—	—	—			46T232114	1	133	201	12.5	3	1.5	0.33	2.07	3.09	2.03	19.4
127.000	182.563	85.725	73.025	3.6	0.8	389	858	5.0000	7.1875	3.3750	2.8750			NA48291/48220D	2	145	173	6.4	3.6	0.8	0.31	2.21	3.29	2.16	6.99
	206.375	107.950	82.550	3.6	0.8	558	1100	5.0000	8.1250	4.2500	3.2500			NA798/792D	2	145	194	12.7	3.6	0.8	0.46	1.47	2.19	1.44	13.2
	234.950	142.875	114.300	3.6	1.6	897	1650	5.0000	9.2500	5.6250	4.5000			NA95500//95927D	1	145	216	14.3	3.6	1.6	0.37	1.83	2.72	1.79	25.6
133.350	215.900	106.363	80.963	3.6	1.6	551	1100	5.2500	8.5000	4.1875	3.1875			NA74525//74851D	1	152	204	12.7	3.6	1.6	0.49	1.38	2.06	1.35	14.0
136.525	190.500	85.725	73.025	3.6	0.8	405	944	5.3750	7.5000	3.3750	2.8750			NA48390//48320D	1	155	181	6.4	3.6	0.8	0.32	2.10	3.13	2.06	7.20
139.700	244.475	107.950	79.375	3.6	1.6	552	989	5.5000	9.6250	4.2500	3.1250			NA81550/81963D	2	158	226	14.3	3.6	1.6	0.35	1.93	2.88	1.89	18.8
142.875	200.025	93.665	73.025	3.6	0.8	422	982	5.6250	7.8750	3.6876	2.8750			NA48686/48620D	2	161	190	10.3	3.6	0.8	0.34	2.01	2.99	1.96	8.43
146.050	236.538	131.763	719	3.6	1.6	719	1460	5.7500	9.3125	5.1875	4.1875			NA82576/82932D	2	164	224	12.7	3.6	1.6	0.44	1.53	2.27	1.49	21.1
	241.300	131.763	719	3.6	1.6	719	1460	5.7500	9.5000	5.1875	4.1875			NA82576/82951D	2	164	224	12.7	3.6	1.6	0.44	1.53	2.27	1.49	22.6
149.225	236.538	131.763	856	3.6	1.6	856	1660	5.8750	9.3125	5.1875	4.1875			HM231149NA/HM231111D	2	168	222	12.7	3.6	1.6	0.32	2.12	3.15	2.07	20.4
152.400	244.475	107.950	552	3.6	1.6	552	989	6.0000	9.6250	4.2500	3.1250			NA81600/81963D	2	171	226	14.3	3.6	1.6	0.35	1.93	2.88	1.89	16.4
	254.000	149.225	111.125	3.6	1.6	941	1830	6.0000	10.0000	5.8750	4.3750			NA99600/99102D	2	171	236	19.1	3.6	1.6	0.41	1.66	2.47	1.62	27.8
165.100	288.925	142.875	1080	3.6	1.6	1080	1950	6.5000	11.3750	5.6250	4.3750			HM237536NA/HM237510D	2	184	270	15.9	3.6	1.6	0.32	2.12	3.15	2.07	36.1
165.496	225.425	95.250	442	3.6	0.8	442	1140	6.5156	8.8750	3.7500	2.7500			NA46790R/46720D	2	184	215	12.7	3.6	0.8	0.38	1.76	2.62	1.72	10.3
	225.425	95.250	442	3.6	0.8	442	1140	6.5156	8.8750	3.7500	2.7500			NA46791R/46720D	2	184	215	12.7	3.6	0.8	0.38	1.76	2.62	1.72	10.3
174.625	247.650	103.188	593	3.6	0.8	593	1400	6.8750	9.7500	4.0625	3.3125			NA6778//67720D	1	193	237	9.5	3.6	0.8	0.44	1.54	2.29	1.50	14.9

[Note] 1) While metric series bearings have minus tolerances for bore and OD, inch series have plus tolerances. Refer to page 190 for details of applicable tolerance standards.

# Double-row tapered roller bearings

## TNA type

d 177.800 ~ 406.400 mm

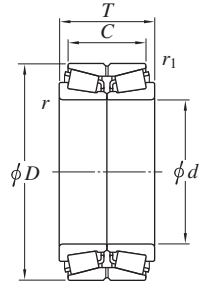

Design 1

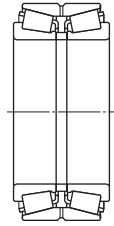

Design 2

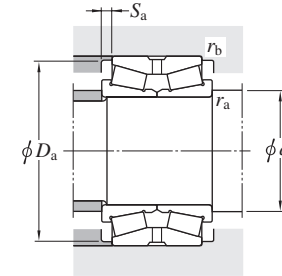

Boundary dimensions					Basic load ratings (kN)		Bearing No. 1)	Design	Mounting dimensions (mm)					Constant <i>e</i>	Axial load factors			Mass (kg)					
<i>d</i> mm	<i>D</i> mm	<i>T</i> mm	<i>C</i> mm	<i>r</i> min.	<i>r</i> <sub>1</sub> min.	<i>C</i> <sub>r</sub>			<i>C</i> <sub>0r</sub>	<i>d</i> <sub>a</sub> min.	<i>D</i> <sub>a</sub> min.	<i>S</i> <sub>a</sub> min.	<i>r</i> <sub>a</sub> max.		<i>r</i> <sub>b</sub> max.	<i>Y</i> <sub>2</sub>	<i>Y</i> <sub>3</sub>		<i>Y</i> <sub>0</sub>				
177.800	7.0000	247.650	9.7500	103.188	4.0625	84.138	3.125	3.6	0.8	593	1 400	<b>NA67790/67720D</b>	2	196	237	9.5	3.6	0.8	0.44	1.54	2.29	1.50	14.2
	7.0000	282.575	11.1250	107.950	4.2500	79.375	3.1250	3.6	1.6	702	1 450	<b>NA87700//87112D</b>	1	196	266	14.3	3.6	1.6	0.42	1.62	2.42	1.59	23.5
	7.0000	288.925	11.3750	142.875	5.6250	111.125	4.3750	5.6	1.6	943	1 920	<b>NA94700//94114D</b>	1	206	269	15.9	5.6	1.6	0.47	1.44	2.15	1.41	33.3
187.325	7.3750	320.675	12.6250	185.738	7.3125	138.113	5.4375	5.6	1.6	1 460	2 530	<b>H239649NA/H239612D</b>	2	216	300	23.8	5.6	1.6	0.32	2.12	3.15	2.07	52.7
190.500	7.5000	266.700	10.5000	109.538	4.3125	84.138	3.3125	3.6	0.8	581	1 410	<b>NA67885SW//20D</b>	1	209	257	12.7	3.6	0.8	0.48	1.42	2.11	1.38	17.5
203.200	8.0000	317.500	12.5000	120.650	4.7500	88.900	3.5000	6.4	1.6	753	1 450	<b>NA132083//132126D</b>	1	232	292	15.9	6.4	1.6	0.31	2.15	3.21	2.11	30.6
	8.0000	317.500	12.5000	146.050	5.7500	111.125	4.3750	5.6	1.6	1 040	2 270	<b>NA93800/93127D</b>	2	232	294	17.5	5.6	1.6	0.52	1.29	1.92	1.26	39.3
228.600	9.0000	355.600	14.0000	146.050	5.7500	111.125	4.3750	6.4	1.6	1 250	2 610	<b>NA130902/131401D</b>	2	257	330	17.5	6.4	1.6	0.33	2.04	3.04	2.00	49.4
241.300	9.5000	368.300	14.5000	120.650	4.7500	85.725	3.3750	6.4	1.6	870	1 850	<b>NA170950//171451D</b>	1	270	335	17.5	6.4	1.6	0.36	1.86	2.77	1.82	41.8
244.475	9.6250	349.148	13.7460	133.350	5.2500	101.600	4.0000	6.4	1.6	950	2 050	<b>NA127096/127136D</b>	2	273	329	15.9	6.4	1.6	0.35	1.91	2.84	1.86	36.3
254.000	10.0000	422.275	16.6250	173.038	6.8125	128.588	5.0625	6.4	1.6	1 730	3 360	<b>HM252343NA/HM252311D</b>	2	282	397	22.2	6.4	1.6	0.33	2.03	3.02	1.98	87.2
	10.0000	422.275	16.6250	173.038	6.8125	128.588	5.0625	6.4	1.6	1 730	3 360	<b>HM252344NA/HM252311D</b>	2	282	397	22.2	6.4	1.6	0.33	2.03	3.02	1.98	87.2
	10.0000	431.724	16.9970	173.038	6.8125	128.588	5.0625	6.4	1.6	1 730	3 360	<b>HM252343NA/HM252315D</b>	2	282	397	22.2	6.4	1.6	0.33	2.03	3.02	1.98	93.5
	10.0000	431.724	16.9970	173.038	6.8125	128.588	5.0625	6.4	1.6	1 730	3 360	<b>HM252344NA/HM252315D</b>	2	282	397	22.2	6.4	1.6	0.33	2.03	3.02	1.98	93.5
	10.0000	431.724	16.9970	173.038	6.8125	128.588	5.0625	6.4	1.6	1 680	3 420	<b>NA551002/551701D</b>	2	282	388	22.2	6.4	1.6	0.33	2.03	3.02	1.98	93.0
	10.0000	431.724	16.9970	173.038	6.8125	128.588	5.0625	6.4	1.6	1 680	3 420	<b>NA551002/551701D</b>	2	282	388	22.2	6.4	1.6	0.33	2.03	3.02	1.98	93.0
260.350	10.2500	400.050	15.7500	146.050	5.7500	107.950	4.2500	6.4	1.6	1 300	2 570	<b>NA221026/221576D</b>	2	289	371	19.1	6.4	1.6	0.39	1.71	2.54	1.67	56.7
	10.2500	422.275	16.6250	173.038	6.8125	128.588	5.0625	6.4	1.6	1 730	3 360	<b>HM252349NA/HM252311D</b>	2	289	397	22.2	1.6	1.6	0.33	2.03	3.02	1.98	87.3
	10.2500	431.724	16.9970	173.038	6.8125	128.588	5.0625	6.4	1.6	1 730	3 360	<b>HM252349NA/HM252315D</b>	2	289	397	22.2	1.6	1.6	0.33	2.03	3.02	1.98	93.6
304.800	12.0000	444.500	17.5000	139.700	5.5000	98.425	3.8750	6.4	1.6	1 240	2 760	<b>NA291201//291751D</b>	1	333	413	20.6	6.4	1.6	0.38	1.79	2.66	1.75	63.8
355.600	14.0000	501.650	19.7500	146.050	5.7500	107.950	4.2500	6.4	1.6	1 350	3 280	<b>NA231400//231976D</b>	1	384	480	19.1	6.4	1.6	0.44	1.53	2.28	1.50	82.2
400	—	590	—	185	—	123	—	6	1.5	2 400	5 110	<b>46T8059NA-1</b>	1	428	558	31	5	1.5	0.32	2.12	3.15	2.07	148
406.400	16.0000	574.675	22.6250	157.163	6.1875	106.363	4.1875	6.4	1.6	1 630	3 880	<b>NA285160//285228D</b>	1	435	535	25.4	6.4	1.6	0.50	1.35	2.01	1.32	112

[Note] 1) While metric series bearings have minus tolerances for bore and OD, inch series have plus tolerances. Refer to page 190 for details of applicable tolerance standards.

Four-row tapered roller bearings

TQO type

d 65 ~ 133.350 mm

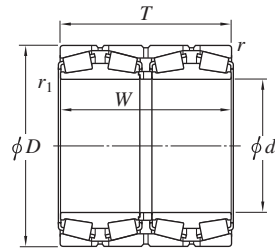

Design 1

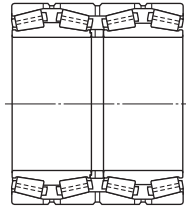

Design 1-P

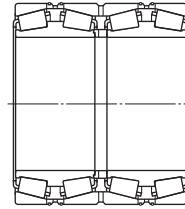

Design 2

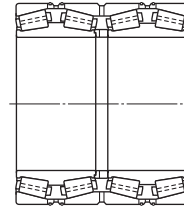

Design 2-P

For oil mist lubrication

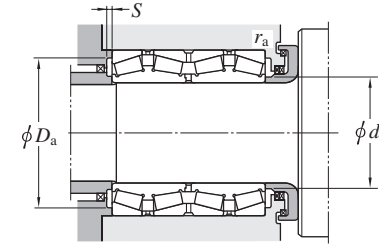

Boundary dimensions								Basic load ratings (kN)		Bearing No. 1)	Design	Mounting dimensions (mm)						Constant e	Axial load factors			(Refer.) Mass (kg)
d	D	T	W	r	r1	Cr	Cor	da	Da			S	ra	rb	Y2	Y3	Y0					
mm	mm	mm	mm	mm	mm			max.	max.	min.	max.	max.										
65	100	98	98	1.5	0.3	309	550	73	91.5	87	3.6	1.5	0.3	0.46	1.47	2.19	1.44	2.82				
80	115	88	88	1.5	1.5	265	543	91	106.5	102	3.4	1.5	1.5	0.33	2.03	3.02	1.98	2.99				
95	130	100	100	1.5	1.5	347	729	104	121.5	117	3.5	1.5	1.5	0.33	2.03	3.02	1.98	3.83				
100	140	104	104	2	2.5	338	661	112	130	125	3.8	2	2	0.28	2.37	3.53	2.32	4.6				
	140	104	104	2	1	407	852	110	130	125	4.1	2	1	0.40	1.68	2.50	1.64	4.8				
	170	155	155	2	2.5	787	1470	119	160	149	5.7	2	2	0.35	1.95	2.90	1.91	14.7				
105	160	150	150	1.5	1	747	1420	118	151.5	146	5.9	1.5	1	0.33	2.03	3.02	1.98	10.6				
110	155	114	114	2	2.5	475	955	121	145	140	4.8	2	2	0.33	2.03	3.02	1.98	6.45				
	160	115	115	1.5	1	548	1030	121	151.5	146	5.2	1.5	1	0.43	1.57	2.34	1.53	7.63				
	180	154	154	2	2.5	882	1530	127	170	162	5.9	2	2	0.39	1.74	2.59	1.70	15.4				
	180	170	170	1	1	989	1770	126	174.5	162	6.5	1	1	0.33	2.03	3.02	1.98	17				
115	155	115	115	1.5	0.6	437	1020	126	146.5	142	3.4	1.5	0.6	0.40	1.68	2.50	1.64	6.12				
	160	120	120	1.5	0.6	560	1160	124	151.5	147	5.7	1.5	0.6	0.35	1.95	2.90	1.91	7.2				
120	170	124	124	2	2.5	472	943	135	160	155	4.1	2	2	0.28	2.37	3.53	2.32	8.56				
	170	130	130	1.5	2	591	1290	133	161.5	155	4.4	1.5	2	0.40	1.68	2.50	1.64	9.38				
	200	132	132	2	2.5	706	1200	143	190	178	5.7	2	2	0.35	1.95	2.90	1.91	16.5				
	210	174	174	2.5	3	1110	1770	143	198	188	4	2	2.5	0.33	2.03	3.02	1.98	24.5				
120.650	161.925	106.365	106.365	1.6	1.6	322	771	130	153	147	5.1	1.6	1.6	0.43	1.56	2.32	1.52	6.24				
	166.688	152.414	152.400	3.3	1.6	637	1460	132	155	150	2.3	3.3	1.6	0.29	2.30	3.42	2.25	9.84				
	174.625	139.703	141.288	1.6	0.8	712	1450	133	166	159	4.9	1.6	0.8	0.33	2.03	3.02	1.98	11.1				
127.000	182.563	158.750	158.750	3.2	1.6	778	1720	140	171	166	3.7	3.2	1.6	0.31	2.21	3.29	2.16	13.6				
130	184	134	134	2	2.5	645	1330	143	174	169	4.3	2	2	0.33	2.03	3.02	1.98	11				
133.350	196.850	193.675	193.675	3.2	1.6	1070	2240	148	185	180	5.6	3.2	1.6	0.34	1.96	2.92	1.92	19.8				

[Note] 1) While metric series bearings have minus tolerances for bore and OD, inch series have plus tolerances. Refer to page 190 for details of applicable tolerance standards.



# Four-row tapered roller bearings

TQO type  
d 135 ~ 170 mm

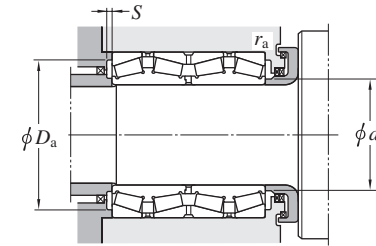
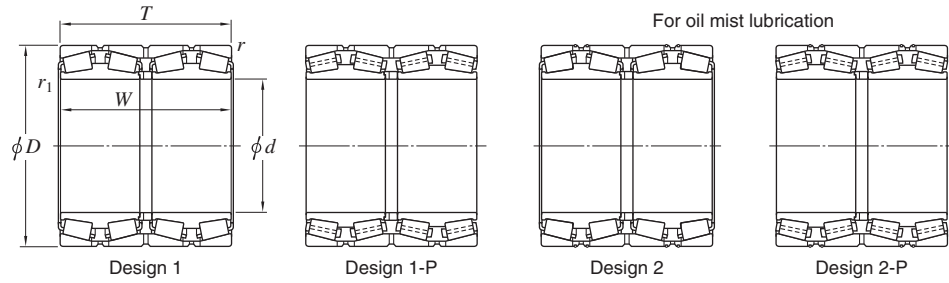

Boundary dimensions						Basic load ratings (kN)		Bearing No. 1)	Design	Mounting dimensions (mm)						Constant e	Axial load factors			(Refer.) Mass (kg)				
d	D	T	W	r	r1	Cr	Cor			da	Da	S	ra	rb	Y2		Y3	Y0						
mm	mm	mm	mm	mm	mm			max.	max.	min.	max.	max.												
<b>135</b>	—	180	—	160	—	160	—	1.5	1	<b>47T271816</b>	1	146	171.5	166	1.4	1.5	1	0.33	2.03	3.02	1.98	10.7		
	—	195	—	160	—	160	—	1.5	0.6			<b>47T272016</b>	1	147	186.5	179	3.9	1.5	0.6	0.33	2.03	3.02	1.98	15.4
<b>136.525</b>	5.3750	190.500	7.5000	161.925	6.3750	161.925	6.3750	3.2	1.6	<b>47T271916</b>	2	150	179	174	4.8	3.2	1.6	0.32	2.10	3.13	2.06	14.3		
	5.3750	190.500	7.5000	161.925	6.3750	161.925	6.3750	3.2	1.6			<b>48393D/20/20D</b>	1	150	179	174	4.8	3.2	1.6	0.32	2.10	3.13	2.06	14.3
<b>139.700</b>	5.5000	200.025	7.8750	160.340	6.3126	157.166	6.1876	3.3	0.8	<b>48680D/20/20D</b>	1	157	187	182	4	3.3	0.8	0.34	2.01	2.99	1.96	16.6		
<b>140</b>	—	198	—	144	—	144	—	2	2.5	<b>37228</b>	1	157	188	183	5.3	2	2	0.28	2.43	3.61	2.37	13.6		
	—	210	—	114	—	114	—	2	2.5			<b>47228</b>	1	160	200	190	6	2	2	0.27	2.47	3.67	2.41	13.7
	—	225	—	145	—	145	—	2.5	3			<b>47328</b>	1	161	213	203	6.5	2	2.5	0.40	1.68	2.50	1.64	21.2
<b>145</b>	—	195	—	130	—	130	—	1.5	0.6	<b>47T292013</b>	1	158	186.5	177	5.1	1.5	0.6	0.40	1.68	2.50	1.64	11.1		
<b>150</b>	—	210	—	190	—	190	—	2	0.6	<b>47T302119</b>	1	163	200	190	5	2	0.6	0.39	1.74	2.59	1.70	20.2		
	—	212	—	155	—	155	—	2.5	3			<b>37230</b>	1	168	200	190	6	2	2.5	0.28	2.37	3.53	2.32	16.7
<b>152.400</b>	6.0000	222.250	8.7500	174.625	6.8750	174.625	6.8750	1.6	1.6	<b>M231649D/610/610D</b>	1	168	213	201	6	1.6	1.6	0.33	2.03	3.02	1.98	22.8		
<b>160</b>	—	226	—	165	—	165	—	2.5	3	<b>37232</b>	1	178	214	204	6	2	2.5	0.28	2.37	3.53	2.32	20.1		
	—	250	—	145	—	145	—	2.5	3			<b>47T322515</b>	1	182	238	226	6.5	2	2.5	0.33	2.03	3.02	1.98	25.4
	—	265	—	173	—	173	—	2.5	1			<b>47T322717</b>	1	193	253	241	7	2	1	0.35	1.95	2.90	1.91	37.6
<b>165.100</b>	6.5000	225.425	8.8750	168.275	6.6250	165.100	6.5000	3.2	0.8	<b>46791D/20/21D</b>	1	180	213	203	4.5	3.2	0.8	0.38	1.77	2.63	1.73	19.7		
<b>168.275</b>	6.6250	247.650	9.7500	192.088	7.5625	192.088	7.5625	3.2	1.6	<b>67782D/20/21D</b>	1	189	236	226	5	3.2	1.6	0.44	1.54	2.29	1.50	31.7		
<b>170</b>	—	230	—	175	—	175	—	2	1	<b>47T342318</b>	1	183	220	210	6	2	1	0.40	1.68	2.50	1.64	19.9		
	—	240	—	175	—	175	—	2.5	3			<b>37234A</b>	1	189	228	218	5	2	2.5	0.33	2.03	3.02	1.98	24.2
	—	240	—	175	—	175	—	2.5	1.5			<b>47T342418A</b>	2	184	228	218	7.5	2	1.5	0.40	1.68	2.50	1.64	24.7
	—	260	—	160	—	160	—	2.5	3			<b>47T342616</b>	1	194	248	238	6	2	2.5	0.35	1.95	2.90	1.91	28.5
	—	280	—	181	—	181	—	2.5	3			<b>47334/181</b>	1	202	268	250	6	2	2.5	0.33	2.03	3.02	1.98	44
	—	280	—	185	—	185	—	2.5	3			<b>47334</b>	1	202	268	250	6	2	2.5	0.33	2.03	3.02	1.98	44.8

[Note] 1) While metric series bearings have minus tolerances for bore and OD, inch series have plus tolerances. Refer to page 190 for details of applicable tolerance standards.

# Four-row tapered roller bearings

**TQO type**  
*d* 177.800 ~ 205 mm

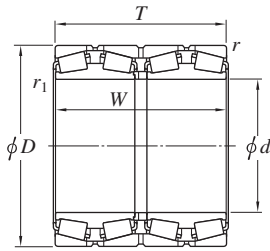

Design 1

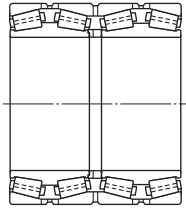

Design 1-P

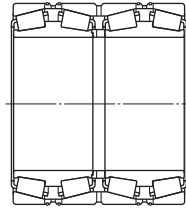

Design 2

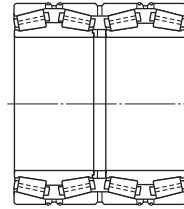

Design 2-P

For oil mist lubrication

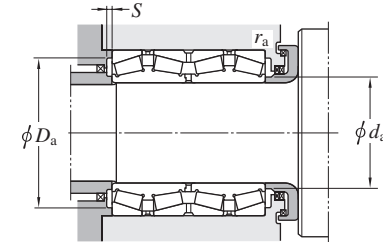

Boundary dimensions					Basic load ratings (kN)		Bearing No. <sup>1)</sup>	Design	Mounting dimensions (mm)						Constant <i>e</i>	Axial load factors			(Refer.) Mass (kg)						
<i>d</i>	<i>D</i>	<i>T</i>	<i>W</i>	<i>r</i>	<i>r</i> <sub>1</sub>	<i>C</i> <sub>T</sub>			<i>C</i> <sub>0r</sub>	<i>d</i> <sub>a</sub>	<i>D</i> <sub>a</sub>	<i>S</i>	<i>r</i> <sub>a</sub>	<i>r</i> <sub>b</sub>		<i>e</i>	<i>Y</i> <sub>2</sub>	<i>Y</i> <sub>3</sub>		<i>Y</i> <sub>0</sub>					
mm	mm	mm	mm	mm	min.	min.		max.	max.	min.	max.	max.													
177.800	7.0000	247.650	9.7500	192.088	7.5625	192.088	7.5625	3.2	1.6	1 190	2 800	<b>67791D/20/21D</b> <b>82681D/20/20D</b> <b>EE91700D/112/113XD</b>	1	189	235	225	5	3.2	1.6	0.44	1.54	2.29	1.50	28.4	
	7.0000	279.400	11.0000	234.948	9.2499	234.950	9.2500	3.2	1.6	1 660	3 290			1	197	267	251	6.5	3.2	1.6	0.52	1.29	1.92	1.26	52.5
	7.0000	285.750	11.2500	222.245	8.7498	222.500	8.7598	3.2	1.6	1 520	2 860			1	201	273	251	3.5	3.2	1.6	0.43	1.57	2.34	1.53	53.7
180	—	250	—	185	—	185	—	2.5	3	1 140	2 550	<b>47T362519</b> <b>37236</b> <b>47T362616</b> <b>47T362620</b> <b>47T362818A</b> <b>47336</b> <b>47T363028</b>	1	198	238	228	6	2	2.5	0.33	2.03	3.02	1.98	26.9	
	—	254	—	185	—	185	—	2.5	3	1 140	2 550			1	198	242	232	6	2	2.5	0.33	2.03	3.02	1.98	29.1
	—	260	—	160	—	160	—	2.5	1	1 090	2 090			1	198	248	238	5	2	1	0.37	1.80	2.69	1.76	26.4
	—	260	—	200	—	200	—	2	2.5	1 390	2 950			1	200	250	240	4.5	2	2	0.31	2.15	3.20	2.10	33.6
	—	280	—	181	—	181	—	2.5	3	1 510	2 830			1	204	268	253	8	2	2.5	0.33	2.03	3.02	1.98	40.8
	—	300	—	202	—	202	—	3	4	1 580	2 750			1	211	286	267	5.5	2.5	3	0.35	1.95	2.90	1.91	54.9
	—	300	—	280	—	280	—	3	4	2 400	4 430			1	211	286	270	6	2.5	3	0.33	2.03	3.02	1.98	78.4
187	—	270	—	210	—	210	—	2.5	1	1 660	3 570	<b>47T372721B</b>	1	205	258	248	8	2	1	0.33	2.03	3.02	1.98	39.1	
187.325	7.3750	269.875	10.6250	211.138	8.3125	211.138	8.3125	3.2	1.6	1 410	3 220	<b>M238849D/810/810D</b>	1	206	257	245	5	3.2	1.6	0.33	2.03	3.02	1.98	39.5	
190	—	268	—	196	—	196	—	2.5	3	1 210	2 760	<b>37238</b> <b>47T382716</b>	1	210	256	246	6	2	2.5	0.33	2.03	3.02	1.98	33.4	
	—	270	—	160	—	160	—	2.5	1	1 170	2 370			1	208	258	248	7	2	1	0.40	1.68	2.50	1.64	28.3
190.000	7.4803	270.000	10.6299	190.000	7.4803	190.000	7.4803	3.2	1.6	1 160	2 810	<b>4TR3827</b>	1	208	257	244	6	3.2	1.6	0.48	1.42	2.11	1.38	34.7	
190.500	7.5000	266.700	10.5000	188.913	7.4375	187.325	7.3750	3.2	1.6	1 160	2 810	<b>67885D/67820/67820D</b>	1	208.5	255.3	245.1	6	3.2	1.6	0.48	1.42	2.11	1.38	32.4	
198.438	7.8125	284.163	11.1875	225.425	8.8750	225.425	8.8750	3.2	1.6	1 740	3 780	<b>M240648D/611/611D</b>	1	215	271	260	5	3.2	1.6	0.33	2.03	3.02	1.98	44.7	
200	—	280	—	206	—	206	—	2.5	1.5	1 670	3 830	<b>47T402821</b> <b>37240</b> <b>47T403423</b>	1	216	268	258	6.5	2	1.5	0.39	1.71	2.54	1.67	39.7	
	—	282	—	206	—	206	—	2.5	3	1 490	3 380			1	223	270	260	5.5	2	2.5	0.28	2.43	3.61	2.37	39.6
	—	340	—	234	—	234	—	3	4	2 340	4 150			1	234	326	302	6	2.5	4	0.40	1.68	2.50	1.64	86
203.200	8.0000	317.500	12.5000	209.550	8.2500	215.900	8.5000	3.2	3.2	1 510	2 900	<b>EE132082D/125/126D</b> <b>93800D/125/127D</b>	1	235	304	284	7	3.2	3.2	0.31	2.15	3.21	2.11	61	
	8.0000	317.500	12.5000	266.700	10.5000	266.700	10.5000	3.2	1.6	2 070	4 540			1	223	304	278	6.5	3.2	1.6	0.52	1.29	1.92	1.26	78.8
205	—	320	—	205	—	205	—	3	4	1 740	3 030	<b>47T413221</b>	1	230	306	292	7.5	2.5	3	0.46	1.46	2.17	1.42	58.9	

[Note] 1) While metric series bearings have minus tolerances for bore and OD, inch series have plus tolerances. Refer to page 190 for details of applicable tolerance standards.

Four-row tapered roller bearings

TQO type  
*d* 206.375 ~ 235 mm

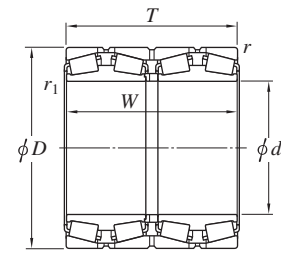

Design 1

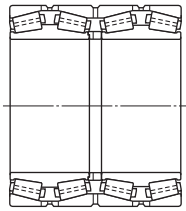

Design 1-P

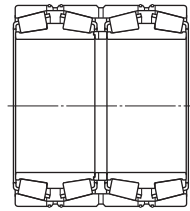

Design 2

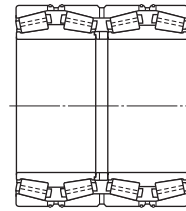

Design 2-P

For oil mist lubrication

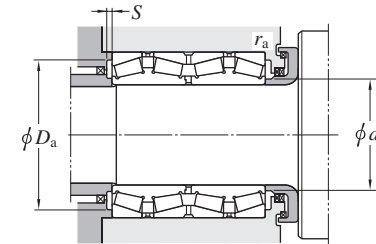

Boundary dimensions						Basic load ratings (kN)		Bearing No. <sup>1)</sup>	Design	Mounting dimensions (mm)						Constant <i>e</i>	Axial load factors			(Refer.) Mass (kg)			
<i>d</i> mm	<i>D</i> mm	<i>T</i> mm	<i>W</i> mm	<i>r</i> min.	<i>r</i> <sub>1</sub> min.	<i>C</i> <sub>T</sub>	<i>C</i> <sub>Or</sub>			<i>d</i> <sub>a</sub> max.	<i>D</i> <sub>a</sub> max.	<i>S</i> min.	<i>r</i> <sub>a</sub> max.	<i>r</i> <sub>b</sub> max.	<i>e</i>		<i>Y</i> <sub>2</sub>	<i>Y</i> <sub>3</sub>	<i>Y</i> <sub>0</sub>				
206.375	8.1250	282.575	11.1250	184.150	7.2500	184.150	7.2500	3.2	0.8	1 200	2 830	67985D/20/20D						1	0.51	1.33	1.97	1.30	33.9
	8.1250	282.575	11.1250	190.500	7.5000	190.500	7.5000	3.2	0.8	1 200	2 830	67986D/20/21D						1	0.51	1.33	1.97	1.30	34.8
	8.1250	282.575	11.1250	210.000	8.2677	210.000	8.2677	3.2	0.8	1 380	3 010	47T412821A						1	0.43	1.57	2.34	1.53	36.2
215.090	8.4681	311.150	12.2500	228.600	9.0000	228.600	9.0000	3.2	1.6	1 750	4 040	47T433123						1	0.40	1.68	2.50	1.64	57.5
215.900	8.5000	288.925	11.3750	177.800	7.0000	177.800	7.0000	3.2	0.8	1 220	3 120	LM742749D/714/714D						1	0.48	1.40	2.09	1.37	32.8
	8.5000	336.550	13.2500	266.700	10.5000	266.700	10.5000	3.2	6.4	2 430	4 760	47T433427						1	0.50	1.34	2.00	1.32	85.1
216.103	8.5080	330.200	13.0000	269.875	10.6250	263.525	10.3750	3.2	1.6	2 500	5 120	47T433327						1	0.46	1.47	2.19	1.44	81.6
220	—	300	—	230	—	230	—	2.5	3	1 750	4 040	47T443023						1	0.40	1.68	2.50	1.64	45.1
	—	310	—	226	—	226	—	3	4	1 690	3 880	37244						1	0.33	2.03	3.02	1.98	52
	—	320	—	201	—	201	—	3	3	1 660	3 760	47T443220						1	0.33	2.03	3.02	1.98	52.4
	—	320	—	250	—	250	—	2.5	3	1 930	4 230	47T443225						1	0.35	1.95	2.90	1.91	64.7
	—	330	—	260	—	260	—	3	1	2 350	5 070	47T443326A						1	0.40	1.68	2.50	1.64	78.4
	—	330	—	260	—	260	—	3	1	2 330	4 860	47T443326B						2	0.55	1.24	1.84	1.21	77.5
	—	340	—	190	—	190	—	3	4	1 490	2 910	47244						1	0.28	2.43	3.61	2.37	62.2
	—	340	—	280	—	280	—	3	1	2 720	5 580	47T443428-1						1	0.33	2.03	3.02	1.98	95.1
	—	340	—	305	—	305	—	3	4	2 910	5 940	47T443431						1	0.35	1.95	2.90	1.91	99.6
	220.662	8.6875	314.325	12.3750	290.000	11.4173	290.000	11.4173	3.2	1.6	2 300	5 050	47T443129A						1	0.33	2.03	3.02	1.98
220.663	8.6875	314.325	12.3750	239.713	9.4375	239.713	9.4375	3.2	1.6	2 100	4 890	M244249D/210/210D						1	0.33	2.03	3.02	1.98	59
225	—	320	—	230	—	230	—	2	2.5	1 670	3 730	4TR225A						1	0.37	1.80	2.69	1.76	57
228.600	9.0000	311.150	12.2500	200.025	7.8750	200.025	7.8750	3.2	1.6	1 660	3 760	LM245149D/110/110D						1	0.33	2.03	3.02	1.98	41.8
230	—	315	—	190	—	190	—	2	2.5	1 510	3 470	47T463119						1	0.37	1.80	2.69	1.76	43
234.950	9.2500	327.025	12.8750	196.850	7.7500	196.850	7.7500	3.2	1.6	1 600	3 720	8576D/20/20D						1	0.41	1.66	2.47	1.62	50.1
235	—	325	—	240	—	240	—	2.5	1.5	2 200	5 310	47T473324						1	0.33	2.03	3.02	1.98	60.5

[Note] 1) While metric series bearings have minus tolerances for bore and OD, inch series have plus tolerances. Refer to page 190 for details of applicable tolerance standards.

# Four-row tapered roller bearings

**TQO type**  
d 240 ~ (260) mm

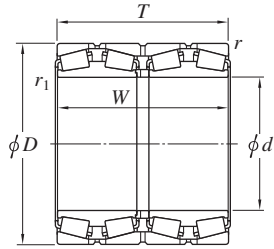

Design 1

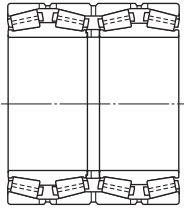

Design 1-P

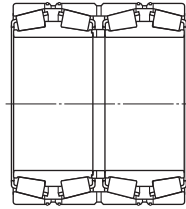

Design 2

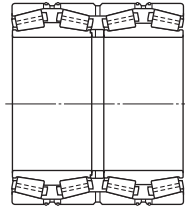

Design 2-P

For oil mist lubrication

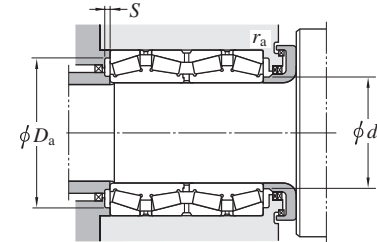

Boundary dimensions						Basic load ratings (kN)		Bearing No. 1)	Design	Mounting dimensions (mm)						Constant e	Axial load factors			(Refer.) Mass (kg)					
d	D	T	W	r	r1 2)	Cr	COr			da	Da	S	ra	rb	Y2		Y3	Y0							
mm	mm	mm	mm	mm	min.	min.		max.	max.	min.	min.	max.	max.												
240	—	320	—	250	—	250	—	2	1	1 880	4 760	<b>47T483225B</b>		1	257	310	299	7.5	2	1	0.33	2.03	3.02	1.98	54.2
	—	338	—	248	—	248	—	3	4	2 360	5 360	<b>37248</b>		1	259	324	312	8.5	2.5	3	0.39	1.74	2.59	1.70	68.4
	—	338	—	248	—	248	—	3	4	2 360	5 360	<b>37248/DP1</b>		2	259	324	312	8.5	2.5	3	0.39	1.74	2.59	1.70	68.4
	—	360	—	194	—	194	—	3	4	1 830	3 580	<b>47248</b>		1	272	346	327	8.5	2.5	3	0.32	2.12	3.15	2.07	66.5
	—	360	—	214	—	214	—	3	2.5	2 170	4 340	<b>47T483621</b>		1	268	346	328	9	2.5	2.5	0.40	1.68	2.50	1.64	75.4
	—	360	—	308.5	—	308.5	—	3	2.5	3 320	7 400	<b>47T483631A</b>		1	268	346	329	9.5	2.5	2.5	0.26	2.55	3.80	2.50	112
	—	365	—	290	—	290	—	2	SP	2 870	5 930	<b>47T483729</b>		1	265	355	333	9	2	0.8	0.46	1.47	2.19	1.44	108
	—	410	—	270	—	270	—	4	2.5	3 220	5 520	<b>47T484127A</b>		1	281	392	369	8.5	3	2	0.40	1.68	2.50	1.64	144
<b>241.478</b>	9.5070	349.148	13.7460	228.600	9.0000	228.600	9.0000	3.2	1.6	2 190	4 920	<b>47T483523A</b>		1	267	335	319	8.5	3.2	1.6	0.35	1.91	2.84	1.86	72.9
	9.5070	349.148	13.7460	228.600	9.0000	228.600	9.0000	3.2	1.6	1 900	4 100	<b>EE127097D/135/136D</b>		1	267	335	319	5.5	3.2	1.6	0.35	1.91	2.84	1.86	70.4
<b>244.475</b>	9.6250	327.025	12.8750	193.675	7.6250	193.675	7.6250	3.2	1.6	1 470	3 500	<b>47T493319</b>		1	259	313	303	5.5	3.2	1.6	0.55	1.24	1.84	1.21	44.4
	9.6250	327.025	12.8750	193.675	7.6250	193.675	7.6250	3.2	1.6	1 570	3 780	<b>LM247748D/710/710D</b>		1	265	313	305	7.5	3.2	1.6	0.32	2.10	3.13	2.06	44.4
	9.6250	381.000	15.0000	304.800	12.0000	304.800	12.0000	4.8	3.2	2 700	5 870	<b>EE126096D/150/151D</b>		1	269	364	336	6	4.8	3.2	0.52	1.31	1.95	1.28	129
<b>247.650</b>	9.7500	400.050	15.7500	253.995	9.9998	249.235	9.8124	6.4	1.6	2 600	5 140	<b>EE220975D/1575/1576D</b>		1	292	379	359	7.5	6.4	1.6	0.39	1.71	2.54	1.67	123
250	—	350	—	240	—	240	—	2.5	1	2 180	4 970	<b>47T503524</b>		1	270	338	324	6	2	1	0.40	1.68	2.50	1.64	70
	—	365	—	270	—	270	—	3	1.5	2 650	6 340	<b>47T503627</b>		1	277	351	330	8	2.5	1.5	0.33	2.03	3.02	1.98	96.7
<b>254.000</b>	10.0000	358.775	14.1250	147.000	5.7874	147.000	5.7874	3.2	1.6	1 320	2 910	<b>47T513615</b>		1	290	345	331	7	3.2	1.6	0.33	2.03	3.02	1.98	46.9
	10.0000	358.775	14.1250	269.875	10.6250	269.875	10.6250	3.2	1.6	2 650	6 340	<b>47T513627A</b>		2	277	345	330	8	3.2	1.6	0.33	2.03	3.02	1.98	85.8
	10.0000	358.775	14.1250	269.875	10.6250	269.875	10.6250	3.2	1.6	2 630	6 030	<b>47T513627B</b>		1	272	345	331	7.5	3.2	1.6	0.46	1.47	2.19	1.44	85.5
	10.0000	358.775	14.1250	269.875	10.6250	269.875	10.6250	3.2	1.6	2 630	6 030	<b>47T513627C</b>		2	272	345	331	7.5	3.2	1.6	0.46	1.47	2.19	1.44	86.1
	10.0000	358.775	14.1250	269.875	10.6250	269.875	10.6250	3.2	3.2	2 650	6 340	<b>M249748D/710/710D</b>		1	277	345	330	8	3.2	3.2	0.33	2.03	3.02	1.98	86
260	—	360	—	272	—	272	—	3	1	2 910	7 020	<b>47T523627A</b>		1	280	346	335	9	2.5	1	0.33	2.03	3.02	1.98	83.6
	—	368	—	268	—	268	—	4	5	2 510	6 020	<b>37252</b>		1	286	350	338	6	3	4	0.33	2.03	3.02	1.98	88.4
	—	400	—	220	—	220	—	4	1.5	2 390	4 520	<b>47T524022</b>		1	295	382	364	7.5	3	1.5	0.40	1.68	2.50	1.64	98.5
	—	400	—	255	—	255	—	7.5	5	2 620	5 400	<b>47T524026</b>		1	296	400	360	9	6	4	0.39	1.72	2.56	1.68	113
	—	400	—	320	—	320	—	4	5	3 270	7 070	<b>47T524032</b>		1	294	382	361	8.5	3	4	0.33	2.03	3.02	1.98	145

[Notes] 1) While metric series bearings have minus tolerances for bore and OD, inch series have plus tolerances. Refer to page 190 for details of applicable tolerance standards.

2) SP indicates the specially chamfered form.

# Four-row tapered roller bearings

## TQO type d (260) ~ 288.925 mm

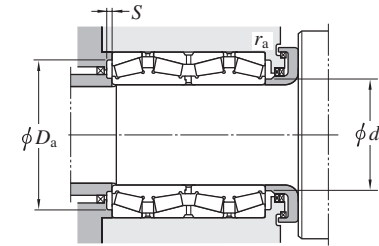
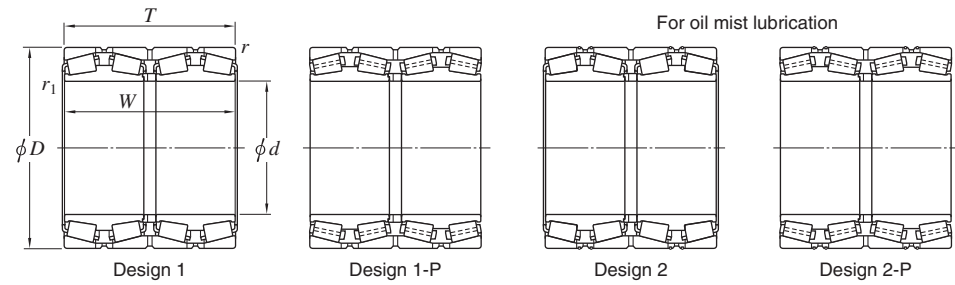

Boundary dimensions								Basic load ratings (kN)		Bearing No. <sup>1)</sup>	Design	Mounting dimensions (mm)						Constant <i>e</i>	Axial load factors			(Refer.) Mass (kg)		
<i>d</i> mm	<i>D</i> mm	<i>T</i> mm	<i>W</i> mm	<i>r</i> mm	<i>r</i> <sub>1</sub> mm	<i>C<sub>r</sub></i>	<i>C</i> <sub>Or</sub>	<i>d</i> <sub>a</sub> max.	<i>D</i> <sub>a</sub> max.			<i>S</i> min.	<i>r</i> <sub>a</sub> min.	<i>r</i> <sub>b</sub> max.	<i>Y</i> <sub>2</sub>	<i>Y</i> <sub>3</sub>	<i>Y</i> <sub>0</sub>							
<b>260</b>	—	440	—	300	—	300	—	4	5	3 470	6 880	<b>47352</b>	1	311	422	392	10	3	4	0.35	1.95	2.90	1.91	188
<b>260.350</b>	10.2500	422.275	16.6250	317.500	12.5000	314.325	12.3750	3.2	6.4	3 470	6 720	<b>HM252348D/310/310D</b>	1	304	407	384	1	3.2	6.4	0.33	2.03	3.02	1.98	167
<b>266.700</b>	10.5000	335.600	13.2126	228.600	9.0000	230.188	9.0625	3.2	1.6	1 850	5 260	<b>47T533423</b>	1	281	322	312	7	3.2	1.6	0.28	2.43	3.61	2.37	46.4
	10.5000	355.600	14.0000	228.600	9.0000	230.188	9.0625	3.2	1.6	2 230	5 690	<b>47T533623B</b>	1	285	342	332	8	3.2	1.6	0.36	1.87	2.79	1.83	62.7
	10.5000	355.600	14.0000	228.600	9.0000	230.188	9.0625	3.2	1.6	1 980	4 830	<b>76589D/20/20D</b>	1	285	342	331	7	3.2	1.6	0.37	1.83	2.73	1.79	59.8
	10.5000	393.700	15.5000	269.878	10.6251	269.878	10.6251	6.4	1.6	2 990	6 460	<b>47T533927-1</b>	1	294	373	361	8.5	6.4	1.6	0.40	1.68	2.50	1.64	112
<b>269.875</b>	10.6250	381.000	15.0000	282.575	11.1250	282.575	11.1250	3.2	3.2	2 930	6 690	<b>M252349D/310/310D</b>	1	291	367	350	6	3.2	3.2	0.33	2.03	3.02	1.98	98.4
<b>270</b>	—	364	—	260	—	260	—	3	1.5	2 370	5 720	<b>47T543626</b>	1	285	350	338	4.5	2.5	1.5	0.42	1.59	2.37	1.56	72.8
	—	410	—	222	—	222	—	4	5	2 250	4 380	<b>47254</b>	1	308	392	372	6.5	3	4	0.27	2.51	3.74	2.45	100
<b>276.225</b>	10.8750	393.700	15.5000	269.878	10.6251	269.878	10.6251	6.4	1.6	2 730	5 830	<b>47T553927</b>	1	299	373	363	4.5	6.4	1.6	0.40	1.68	2.50	1.64	101
<b>279.400</b>	11.0000	393.700	15.5000	269.875	10.6250	269.875	10.6250	6.4	1.6	2 660	5 990	<b>47T563927A</b>	2	305	373	363	9.5	6.4	1.6	0.40	1.68	2.50	1.64	101
	11.0000	393.700	15.5000	269.875	10.6250	269.875	10.6250	6.4	1.6	2 660	5 990	<b>47T563927B</b>	1	305	373	363	9.5	6.4	1.6	0.40	1.68	2.50	1.64	101
	11.0000	410.000	16.1417	310.000	12.2047	310.000	12.2047	6.4	1.6	3 120	7 290	<b>47T564131</b>	2	308	389	374	8	6.4	1.6	0.40	1.68	2.50	1.64	140
<b>279.578</b>	11.0070	380.898	14.9960	244.475	9.6250	244.475	9.6250	3.2	1.6	2 280	5 650	<b>LM654644D/610/610D</b>	1	303	367	356	6.5	3.2	1.6	0.43	1.57	2.34	1.53	80.4
<b>280</b>	—	380	—	290	—	290	—	2	2	2 810	6 940	<b>47T563829</b>	1	300	370	354	6	2	2	0.33	2.03	3.02	1.98	91.8
	—	380	—	290	—	290	—	2	1	2 810	6 940	<b>47T563829A</b>	2	300	370	354	6	2	1	0.33	2.03	3.02	1.98	92.1
	—	395	—	288	—	288	—	4	2	2 880	6 900	<b>37256X</b>	1	303	377	363	8	3	2	0.40	1.68	2.50	1.64	110
	—	395	—	288	—	288	—	4	2	2 880	6 900	<b>47T564029A</b>	2	303	377	363	8	3	2	0.40	1.68	2.50	1.64	110
	—	420	—	225	—	225	—	4	5	2 390	4 950	<b>47256</b>	1	322	402	382	8.5	3	4	0.25	2.69	4.00	2.63	104
	—	460	—	324	—	324	—	5	6	4 300	8 230	<b>47T564632</b>	1-P	321	438	415	10.5	4	5	0.46	1.47	2.19	1.44	214
<b>280.268</b>	11.0342	379.887	14.9562	244.475	9.6250	244.475	9.6250	3.2	1.6	2 280	5 650	<b>47T563824</b>	1	303	366	355	6.5	3.2	1.6	0.43	1.57	2.34	1.53	80
<b>285.750</b>	11.2500	380.898	14.9960	244.475	9.6250	244.475	9.6250	3.2	1.6	2 280	5 650	<b>LM654648D/610/610D</b>	1	303	367	356	6.5	3.2	1.6	0.43	1.57	2.34	1.53	75.6
<b>288.925</b>	11.3750	406.400	16.0000	298.450	11.7500	298.450	11.7500	3.2	3.2	3 450	8 840	<b>M255449D/410/410D</b>	1	316	392	373	9	3.2	3.2	0.34	2.00	2.97	1.95	127

[Note] 1) While metric series bearings have minus tolerances for bore and OD, inch series have plus tolerances. Refer to page 190 for details of applicable tolerance standards.

Four-row tapered roller bearings

TQO type  
d 292.100 ~ (320) mm

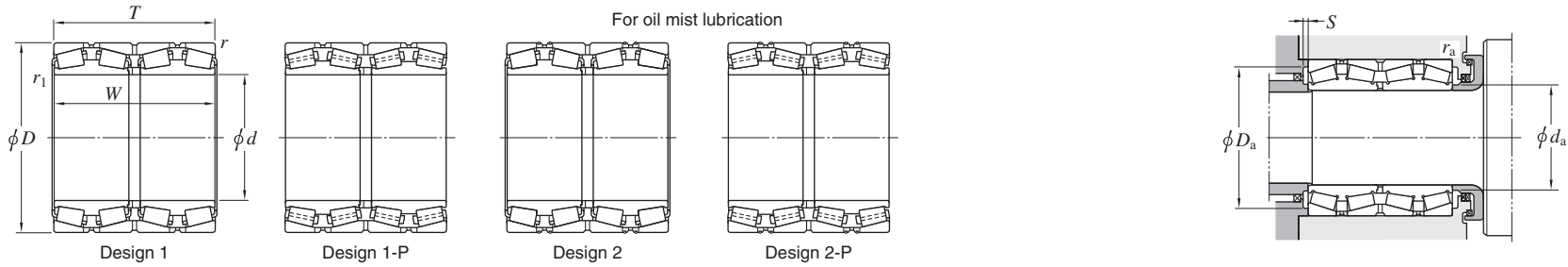

Boundary dimensions					Basic load ratings (kN)		Bearing No. 1)	Design	Mounting dimensions (mm)						Constant $e$	Axial load factors			(Refer.) Mass (kg)					
$d$ mm	$D$ mm	$T$ mm	$W$ mm	$r$ min.	$r_{1,2}$ min.	$C_r$			$C_{Or}$	$d_a$ max.	$D_a$ max.	$S$ min.	$r_a$ max.	$r_b$ max.		$Y_2$	$Y_3$	$Y_0$						
292.100	11.5000	422.275	16.6250	269.875	10.6250	269.875	10.6250	3.2	6.4	3 170	6 830	EE330116D/166/167D	1	321	407	387	7.5	3.2	6.4	0.32	2.11	3.14	2.06	124
300	—	420	—	310	—	310	—	3	1	3 390	8 050	47T604231	1	325	406	388	8.5	2.5	1	0.34	2.00	2.98	1.96	132
—	—	424	—	310	—	310	—	4	5	3 000	6 570	37260	1	334	406	391	6	3	4	0.28	2.37	3.53	2.32	134
—	—	430	—	300	—	300	—	3	4	3 320	7 630	47T604330	1	328	416	393	10	2.5	3	0.35	1.95	2.90	1.91	141
—	—	430	—	310	—	310	—	3	2.5	3 520	8 420	47T604331	1	332	416	399	10	2.5	2	0.40	1.68	2.50	1.64	146
—	—	460	—	248	—	248	—	4	1.5	3 060	6 300	47T604625	1	342	442	416	8.5	3	1.5	0.40	1.68	2.50	1.64	149
—	—	460	—	360	—	360	—	4	5	4 300	9 550	47T604636	1	339	442	416	9	3	4	0.33	2.03	3.02	1.98	220
—	—	470	—	270	—	270	—	4	5	3 500	6 440	47T604727A	1	338	452	426	8	3	4	0.40	1.68	2.50	1.64	165
—	—	470	—	292	—	292	—	4	SP	3 980	7 870	47T604729B	1-P	341	452	428	8.5	3	2	0.40	1.68	2.50	1.64	193
—	—	470	—	292	—	292	—	4	1.5	4 120	8 210	47T604729C	1-P	343	452	428	9.5	3	1.5	0.33	2.03	3.02	1.98	198
—	—	500	—	350	—	350	—	4	2.5	5 010	9 290	47T605035	1	346	482	451	8	3	2	0.40	1.68	2.50	1.64	270
300.038	11.8125	422.275	16.6250	311.150	12.2500	311.150	12.2500	3.2	3.2	3 390	8 050	HM256849D/810/810D	1	325	407	388	7	3.2	3.2	0.34	2.00	2.98	1.96	136
304.648	11.9940	438.048	17.2460	279.400	11.0000	280.990	11.0626	4.8	3.2	3 230	6 980	47T614428C	2	331	420	403	7	4.8	3.2	0.47	1.44	2.15	1.41	133
—	11.9940	438.048	17.2460	279.400	11.0000	280.990	11.0626	4.8	3.2	3 230	6 980	M757448D/410/410D	1	331	420	403	7	4.8	3.2	0.47	1.44	2.15	1.41	132
304.800	12.0000	419.100	16.5000	269.875	10.6250	269.875	10.6250	6.4	1.6	2 840	6 950	M257149D/110/110D	1	331	398	387	7	6.4	1.6	0.33	2.03	3.02	1.98	110
—	12.0000	482.600	19.0000	377.825	14.8750	365.125	14.3750	6.4	3.2	4 820	9 800	47T614838A	1-P	343	461	437	1	6.4	3.2	0.47	1.43	2.12	1.40	250
—	12.0000	495.300	19.5000	349.250	13.7500	342.900	13.5000	6.4	3.2	4 370	9 370	EE724121D/195/196D	1	355	474	438	7	6.4	3.2	0.40	1.68	2.50	1.64	267
304.902	12.0040	412.648	16.2460	266.7	10.5000	266.7	10.5000	3.2	3.2	2 990	7 280	M257248D/210/210D	1	328	398	383	7	3.2	3.2	0.32	2.12	3.15	2.07	101
310	—	430	—	310	—	310	—	3	3	3 520	8 420	47T624331A	1	332	416	399	10	2.5	2.5	0.40	1.68	2.50	1.64	135
—	—	460	—	325	—	325	—	4	5	4 200	9 500	47T6246A	1	346	442	421	12	3	4	0.32	2.12	3.15	2.07	188
317.500	12.5000	422.275	16.6250	269.875	10.6250	269.875	10.6250	3.2	1.6	2 930	7 450	LM258649D/610/610D	1	341	407	392	8.5	3.2	1.6	0.32	2.12	3.15	2.07	104
—	12.5000	447.675	17.6250	327.025	12.8750	327.025	12.8750	6.4	1.6	4 120	9 820	47T644533J	1-P	341	426	411	7.5	6.4	1.6	0.33	2.02	3.00	1.97	161
—	12.5000	447.675	17.6250	327.025	12.8750	327.025	12.8750	6.4	1.6	4 280	10 100	47T644533L	1	344	426	411	11.5	6.4	1.6	0.33	2.03	3.02	1.98	161
320	—	440	—	335	—	335	—	2	2.5	3 590	8 750	47T644434	1	341	430	408	5.5	2	2	0.40	1.68	2.50	1.64	149
—	—	460	—	325	—	325	—	4	2.5	4 030	9 420	47T644633	1	349	442	424	10	3	2.5	0.42	1.62	2.42	1.59	175

[Notes] 1) While metric series bearings have minus tolerances for bore and OD, inch series have plus tolerances. Refer to page 190 for details of applicable tolerance standards.

2) SP indicates the specially chamfered form.

# Four-row tapered roller bearings

TQO type  
 d (320) ~ 355.600 mm

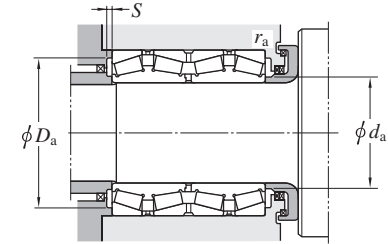
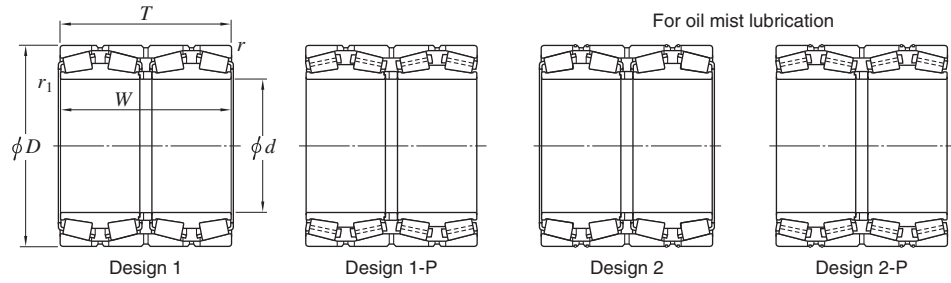

Boundary dimensions						Basic load ratings (kN)		Bearing No. <sup>1)</sup>	Design	Mounting dimensions (mm)						Constant e	Axial load factors			(Refer.) Mass (kg)				
d	D	T	W	r	r <sub>1</sub>	C <sub>r</sub>	C <sub>0r</sub>			d <sub>a</sub>	D <sub>a</sub>	S	r <sub>a</sub>	r <sub>b</sub>	Y <sub>2</sub>		Y <sub>3</sub>	Y <sub>0</sub>						
mm	mm	mm	mm	mm	mm																			
320	—	460	—	338	—	338	—	4	5	3 500	8 590	<b>37264</b>	1	356	442	421	8.5	3	4	0.33	2.03	3.02	1.98	183
	—	480	—	254	—	254	—	4	2.5	3 400	6 940	<b>47T644825</b>	1-P	358	462	437	9	3	2	0.40	1.68	2.50	1.64	161
	—	480	—	260	—	260	—	4	5	3 360	6 890	<b>47T644826</b>	1	359	462	437	11.5	3	5	0.40	1.68	2.50	1.64	165
	—	480	—	360	—	360	—	4	1	4 970	11 000	<b>47T644836-1</b>	1-P	352	462	442	9	3	1	0.47	1.43	2.12	1.40	229
	—	500	—	380	—	380	—	4	1.5	5 540	11 900	<b>47T645038</b>	1-P	363	482	454	11.5	3	1.5	0.33	2.03	3.02	1.98	284
	—	540	—	364	—	364	—	5	6	5 380	10 600	<b>47364</b>	1	376	518	479	8.5	4	5	0.32	2.12	3.15	2.07	340
325	—	430	—	230	—	230	—	3	1	2 410	5 800	<b>47T654323</b>	1	347	416	401	8.5	2.5	1	0.40	1.68	2.50	1.64	88.5
327	—	445	—	230	—	230	—	3	1	2 620	6 080	<b>47T654523</b>	1	353	431	413	9	2.5	1	0.40	1.68	2.50	1.64	102
330.200	13.0000	444.500	17.5000	301.625	11.8750	301.625	11.8750	3.2	3.2	3 550	9 260	<b>47T664430</b>	1	357	430	414	10	3.2	3.2	0.26	2.55	3.80	2.50	134
	13.0000	508.000	20.0000	307.975	12.1250	307.975	12.1250	6.4	1.6	4 320	8 500	<b>47T665131A</b>	1	372	486	462	8	6.4	1.6	0.33	2.03	3.02	1.98	219
335.000	13.1890	460.000	18.1102	342.900	13.5000	342.900	13.5000	3.2	1.6	3 960	9 390	<b>47T674634/DP</b>	2	361	445	428	7.5	3.2	1.6	0.40	1.68	2.50	1.64	165
337.375	13.2825	469.900	18.5000	342.900	13.5000	342.900	13.5000	3.2	1.6	4 630	11 400	<b>HM261049D/010/010D</b>	1-P	360	455	432	9	3.2	1.6	0.33	2.02	3.01	1.97	190
340	—	480	—	350	—	350	—	5	6	4 700	11 700	<b>37268A</b>	1-P	371	458	443	9.5	4	6	0.33	2.03	3.02	1.98	198
	—	520	—	278	—	278	—	5	6	4 040	8 110	<b>47T685228</b>	1	384	498	473	9	4	6	0.40	1.68	2.50	1.64	212
	—	520	—	323	—	323	—	5	6	4 380	8 930	<b>47T685232</b>	1	381	498	473	10	4	5	0.40	1.68	2.50	1.64	242
343.052	13.5060	457.098	17.9960	254.000	10.0000	254.000	10.0000	3.2	1.6	2 850	6 950	<b>47T694625</b>	1	363	442	425	6	3.2	1.6	0.47	1.43	2.12	1.40	111
	13.5060	457.098	17.9960	254.000	10.0000	254.000	10.0000	3.2	1.6	2 850	6 950	<b>47T694625/DP3</b>	2	363	442	425	6	3.2	1.6	0.47	1.43	2.12	1.40	111
346.075	13.6250	488.950	19.2500	358.775	14.1250	358.775	14.1250	3.2	3.2	4 620	11 600	<b>HM262749D/10/10D</b>	1	378	474	449	8	3.2	3.2	0.33	2.02	3.00	1.97	214
347.663	13.6875	469.900	18.5000	292.100	11.5000	292.100	11.5000	3.2	3.2	3 600	9 040	<b>M262449D/10/10D</b>	1	374	455	436	10	3.2	3.2	0.33	2.03	3.02	1.98	145
355	—	490	—	316	—	316	—	2	2.5	4 160	10 000	<b>47T714932</b>	1	385	480	455	12.5	2	2	0.33	2.03	3.02	1.98	180
355.600	14.0000	482.600	19.0000	269.875	10.6250	265.113	10.4375	3.2	1.6	3 390	7 860	<b>47T714827-1</b>	1	386	468	450	8	3.2	1.6	0.26	2.55	3.80	2.50	139
	14.0000	482.600	19.0000	269.875	10.6250	265.112	10.4375	3.2	1.6	3 060	7 020	<b>LM763449D/410/410D</b>	1	381	468	450	3.5	3.2	1.6	0.47	1.43	2.14	1.40	136
	14.0000	488.950	19.2500	317.500	12.5000	317.500	12.5000	3.2	1.6	4 370	10 900	<b>M263349D/310/310D</b>	1-P	383	474	452	7.5	3.2	1.6	0.33	2.03	3.02	1.98	182

[Note] 1) While metric series bearings have minus tolerances for bore and OD, inch series have plus tolerances. Refer to page 190 for details of applicable tolerance standards.

## Four-row tapered roller bearings

TQO type

d 360 ~ 380 mm

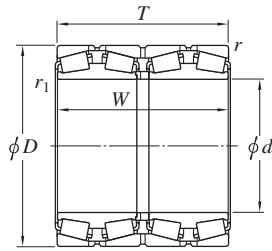

Design 1

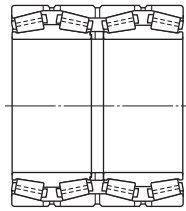

Design 1-P

For oil mist lubrication

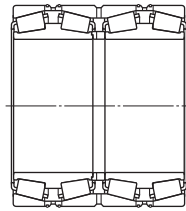

Design 2

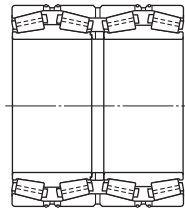

Design 2-P

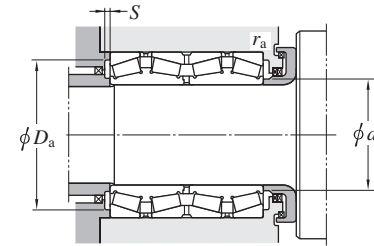

Boundary dimensions					Basic load ratings (kN)		Bearing No. 1)	Design	Mounting dimensions (mm)						Constant	Axial load factors			(Refer.) Mass (kg)						
d	D	T	W	r	r1	Cr			Cor	da	Da	S	ra	rb	e	Y2	Y3	Y0							
mm	1/25.4	mm	1/25.4	mm	1/25.4	mm	1/25.4	min.	min.	max.	max.	min.	min.	max.	max.										
360	—	480	—	375	—	375	—	3	4	3 930	9 910	<b>47T724838A</b>		1	383	466	446	3.5	2.5	3	0.40	1.68	2.50	1.64	177
	—	480	—	375	—	375	—	3	1	4 190	11 100	<b>47T724838C</b>		1	381	466	448	5	2.5	1	0.33	2.03	3.02	1.98	183
	—	508	—	370	—	370	—	5	6	4 840	11 500	<b>47T725137</b>		1	392	486	471	7	4	6	0.33	2.03	3.02	1.98	232
	—	520	—	370	—	370	—	5	6	4 920	11 400	<b>47T725237</b>		1	395	498	476	8.5	4	5	0.33	2.03	3.02	1.98	259
	—	520	—	410	—	410	—	5	6	5 970	14 300	<b>47T725241</b>		1-P	395	498	479	8.5	4	5	0.33	2.03	3.02	1.98	292
	—	540	—	280	—	280	—	5	6	3 790	7 820	<b>47272</b>		1	406	518	490	10	4	5	0.32	2.12	3.15	2.07	221
	—	540	—	280	—	280	—	5	6	3 760	8 000	<b>47T725428</b>		1	402	518	489	10.5	4	5	0.55	1.24	1.84	1.21	224
	—	540	—	460	—	460	—	4	5	6 440	15 800	<b>47T7254</b>		1	408	522	492	9.5	3	4	0.27	2.47	3.67	2.41	373
368.300	14.5000	523.875	20.6250	382.588	15.0625	382.588	15.0625	6.4	3.2	5 530	13 600	<b>47T745238B</b>		1-P	404	502	483	9	6.4	3.2	0.29	2.32	3.45	2.26	269
	14.5000	523.875	20.6250	382.588	15.0625	382.588	15.0625	3.2	1.6	5 620	14 100	<b>47T745238D</b>		1	403	508	483	7.5	3.2	1.6	0.33	2.03	3.02	1.98	265
	14.5000	523.875	20.6250	382.588	15.0625	382.588	15.0625	6.4	3.2	5 920	14 500	<b>47T745238J</b>		1-P	401	502	485	10.5	6.4	3.2	0.33	2.03	3.02	1.98	268
	14.5000	523.875	20.6250	382.588	15.0625	382.588	15.0625	6.4	3.2	5 460	13 600	<b>HM265049D/010/010D</b>		1-P	403	502	483	7	6.4	3.2	0.33	2.03	3.02	1.98	269
	14.5000	563.000	22.1654	382.588	15.0625	382.588	15.0625	6.4	3.2	6 300	13 600	<b>47T745638</b>		1-P	417	541	516	10.5	6.4	3.2	0.29	2.32	3.45	2.26	344
370	—	516	—	346	—	346	—	4	1.5	4 880	11 700	<b>47T745235</b>		1-P	398	498	479	9	3	1.5	0.40	1.68	2.50	1.64	216
374.650	14.7500	501.650	19.7500	260.350	10.2500	260.350	10.2500	3.2	1.6	2 930	7 750	<b>47T745026</b>		1	399	486	459	7	3.2	1.6	0.43	1.56	2.32	1.52	145
380	—	520	—	360	—	360	—	5	6	4 610	12 200	<b>47T765236</b>		1	417	498	484	11	4	5	0.32	2.12	3.15	2.07	225
	—	520	—	400	—	400	—	4	2.5	5 020	13 000	<b>47T765240</b>		1	404	502	482	9.5	3	2	0.40	1.68	2.50	1.64	248
	—	536	—	390	—	390	—	5	6	5 760	12 900	<b>37276</b>		1	415	514	496	7.5	4	5	0.40	1.68	2.50	1.64	268
	—	560	—	282	—	282	—	5	6	3 670	7 580	<b>47276</b>		1	429	538	511	9	4	5	0.27	2.47	3.67	2.41	232
	—	560	—	285	—	285	—	4	5	4 600	10 000	<b>47T765629</b>		1-P	428	542	513	11	3	4	0.27	2.47	3.67	2.41	246
	—	560	—	285	—	285	—	4	5	4 420	9 240	<b>47T765629A</b>		1	427	542	515	11	3	5	0.27	2.47	3.67	2.41	244
	—	560	—	325	—	325	—	5	6	5 330	11 900	<b>47T765633A</b>		1-P	427	538	514	11	4	5	0.27	2.47	3.67	2.41	278
	—	560	—	360	—	390	—	4	1.5	5 310	11 800	<b>47T765639</b>		1	422	542	514	9	3	1.5	0.35	1.95	2.90	1.91	307
	—	560	—	370	—	370	—	5	6	5 910	13 600	<b>47T765637</b>		1-P	423	538	515	10	4	5	0.33	2.03	3.02	1.98	312
	—	580	—	500	—	500	—	5	6	7 410	17 500	<b>47T765850</b>		1	427	558	529	10.5	4	5	0.33	2.03	3.02	1.98	478
	—	620	—	400	—	400	—	5	6	6 130	12 700	<b>47376</b>		1	445	598	552	6.5	4	5	0.32	2.12	3.15	2.07	476
	—	620	—	418.5	—	418.5	—	5	6	7 080	14 000	<b>47T766242</b>		1-P	435	598	561	10	4	5	0.46	1.47	2.19	1.44	499

[Note] 1) While metric series bearings have minus tolerances for bore and OD, inch series have plus tolerances. Refer to page 190 for details of applicable tolerance standards.



# Four-row tapered roller bearings

TQO type

d 384.175 ~ (431.800) mm

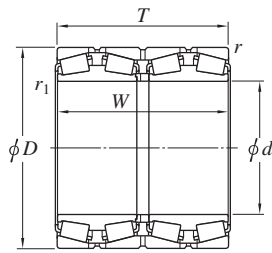

Design 1

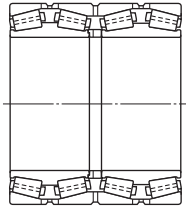

Design 1-P

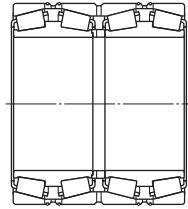

Design 2

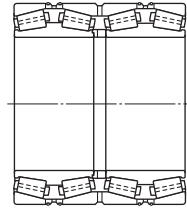

Design 2-P

For oil mist lubrication

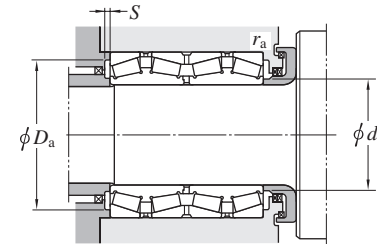

Boundary dimensions						Basic load ratings (kN)		Bearing No. <sup>1)</sup>	Design	Mounting dimensions (mm)						Constant e	Axial load factors			(Refer.) Mass (kg)							
d	D	T	W	r	r <sub>1</sub>	C <sub>r</sub>	C <sub>Or</sub>			d <sub>a</sub>	D <sub>a</sub>	S	r <sub>a</sub>	r <sub>b</sub>	Y <sub>2</sub>		Y <sub>3</sub>	Y <sub>0</sub>									
mm	mm	mm	mm	mm	mm			max.	max.	min.	min.	max.	max.														
384.175	15.1250	546.100	21.5000	400.050	15.7500	400.050	15.7500	6.4	3.2	6 530	16 900	<b>HM266449D/410/410D</b>						0.33	2.03	3.02	1.98	315					
	15.1250	546.100	21.5000	470.000	18.5039	470.000	18.5039	6.4	3.2	6 220	16 200	<b>47T775547</b>											0.33	2.03	3.02	1.98	360
390	—	510	—	350	—	350	—	3	1.5	4 300	11 700	<b>47T785135A</b>						0.33	2.03	3.02	1.98	186					
	—	510	—	350	—	350	—	3	1	4 150	11 200	<b>47T785135B</b>											0.29	2.32	3.45	2.26	183
395	—	545	—	288.7	—	270.3	—	7.5	5	3 330	7 680	<b>47T795529</b>						0.43	1.57	2.34	1.53	190					
400	—	560	—	380	—	380	—	4	1.5	5 970	15 200	<b>47T805638A</b>						0.33	2.03	3.02	1.98	296					
	—	564	—	412	—	412	—	4	2.5	6 470	16 500	<b>47T805641</b>											0.40	1.68	2.50	1.64	329
	—	590	—	304	—	304	—	4	1.5	4 760	10 200	<b>47T805930A</b>											0.33	2.03	3.02	1.98	289
	—	600	—	308	—	308	—	5	6	4 810	9 930	<b>47280</b>											0.33	2.03	3.02	1.98	310
406.400	16.0000	546.100	21.5000	288.925	11.3750	288.925	11.3750	6.4	1.6	3 960	9 540	<b>47T815529</b>						0.47	1.43	2.12	1.40	184					
	16.0000	546.100	21.5000	330.000	12.9921	330.000	12.9921	6.4	3.2	4 800	12 400	<b>47T815533B</b>											0.40	1.68	2.50	1.64	214
	16.0000	562.000	22.1260	381.000	15.0000	381.000	15.0000	6.4	3.2	5 990	15 000	<b>47T815638</b>											0.33	2.03	3.02	1.98	284
	16.0000	565.150	22.2500	381.000	15.0000	381.000	15.0000	6.4	3.2	5 990	15 000	<b>M267949D/910/910XD</b>											0.33	2.03	3.02	1.98	291
409.575	16.1250	546.100	21.5000	334.963	13.1875	334.963	13.1875	6.4	1.6	4 570	11 500	<b>M667947D/911/911D</b>						0.42	1.62	2.42	1.59	213					
415.925	16.3750	590.550	23.2500	434.975	17.1250	434.975	17.1250	6.4	3.2	7 060	18 800	<b>47T835943A</b>						0.33	2.03	3.02	1.98	391					
420	—	560	—	370	—	370	—	5	6	4 950	13 600	<b>47T845637</b>						0.32	2.12	3.15	2.07	252					
	—	560	—	437	—	437	—	4	1.5	5 620	14 900	<b>47T845644</b>											0.26	2.55	3.80	2.50	283
	—	592	—	432	—	432	—	5	6	6 030	15 700	<b>37284</b>											0.33	2.03	3.02	1.98	374
	—	620	—	312	—	312	—	5	6	4 810	10 400	<b>47284</b>											0.33	2.03	3.02	1.98	328
	—	650	—	460	—	460	—	6	6	8 560	18 300	<b>47T846546</b>											0.40	1.68	2.50	1.64	558
430	—	570	—	336	—	336	—	4	1.5	4 790	12 500	<b>47T865734C</b>						0.36	1.87	2.79	1.83	232					
	—	570	—	380	—	380	—	4	1.5	5 640	15 900	<b>47T865738</b>											0.26	2.55	3.80	2.50	269
431.800	17.0000	571.500	22.5000	336.550	13.2500	336.550	13.2500	6.4	1.6	5 070	13 500	<b>47T865734</b>						0.36	1.87	2.79	1.83	232					
	17.0000	571.500	22.5000	336.550	13.2500	336.550	13.2500	6.4	1.6	4 290	11 300	<b>LM769349D/310/310D</b>											0.48	1.41	2.10	1.38	231

[Note] 1) While metric series bearings have minus tolerances for bore and OD, inch series have plus tolerances. Refer to page 190 for details of applicable tolerance standards.

Four-row tapered roller bearings

TQO type

d (431.800) ~ 479.425 mm

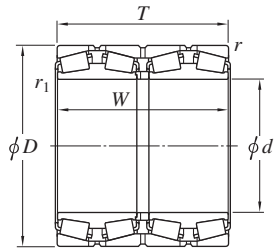

Design 1

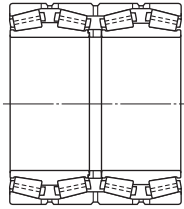

Design 1-P

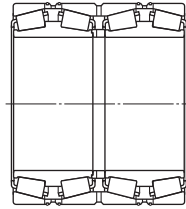

Design 2

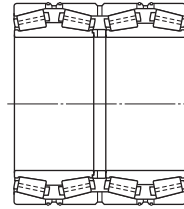

Design 2-P

For oil mist lubrication

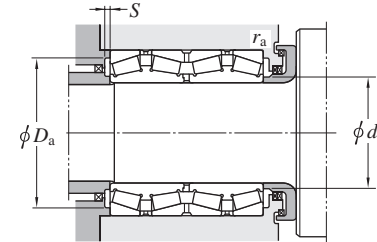

Boundary dimensions					Basic load ratings (kN)		Bearing No. 1)	Design	Mounting dimensions (mm)						Constant e	Axial load factors			Mass (kg) (Refer.)	
d	D	T	W	r	r1	Cr			Cor	da	Da	S	ra	rb		Y2	Y3	Y0		
mm	mm	mm	mm	mm	mm			max.	max.	min.	max.	max.								
431.800	635.000	355.600	355.600	6.4	6.4	6 310	13 700	EE931170D/250/251XD	1-P	481	612	586	8	6.4	6.4	0.32	2.10	3.13	2.06	385
432.003	609.524	317.500	317.500	6.4	3.6	5 210	12 100	EE736173D/238/239D	1-P	474	586	562	9	6.4	3.6	0.35	1.94	2.89	1.90	291
440	580	420	420	4	1.5	5 730	15 400	47T885842	1-P	467	562	544	1.5	3	1.5	0.26	2.55	3.80	2.50	288
	620	454	454	6	6	7 110	17 500	37288	1	482	592	576	9	5	5	0.40	1.68	2.50	1.64	417
	620	454	454	4	5	7 610	19 800	47T886246	1-P	474	602	573	10.5	3	5	0.40	1.68	2.50	1.64	436
	635	430	430	5	6	7 560	18 000	47T886443	1-P	485	613	587	9.5	4	5	0.33	2.03	3.02	1.98	450
	635	470	470	5	2.5	8 510	20 900	47T886447	1-P	483	613	588	10.5	4	2	0.33	2.03	3.02	1.98	500
	650	326	326	6	6	5 080	11 000	47288	1-P	500	622	595	11	5	5	0.28	2.43	3.61	2.37	361
	650	334	334	6	6	5 490	12 200	47288A	1	500	622	595	9.5	5	5	0.28	2.43	3.61	2.37	375
	660	450	450	5	2	8 690	19 000	47T886645	1	489	638	610	9.5	4	2	0.32	2.12	3.15	2.07	532
447.675	635.000	463.550	463.550	6.4	3.2	7 860	21 000	M270749D/710/710D	1-P	491	612	584	8	6.4	3.2	0.33	2.03	3.02	1.98	472
449.949	594.949	368.000	368.000	5	2.5	5 980	16 200	M270449D/10/10D	1-P	478	573	557	9	5	2	0.33	2.03	3.02	1.98	278
450	580	450	450	6	1.5	5 130	14 600	47T905845	1	475	552	537	2	5	1.5	0.26	2.55	3.80	2.50	286
457.200	596.900	279.400	276.225	3.2	1.6	4 260	11 400	47T916028A	1-P	485	581	560	8.5	3.2	1.6	0.47	1.43	2.12	1.40	307
	660.400	323.847	323.850	6.4	3.2	5 700	12 700	EE737179D/260/261D	1-P	501	637	603	9	6.4	3.2	0.37	1.80	2.69	1.76	365
460	586	280	280	3	1	3 710	9 810	47T925928	1	483	572	555	10.5	2.5	1	0.44	1.52	2.26	1.49	177
	615	360	360	3	1	5 000	13 300	47T926236	1	490	601	572	8	2.5	1	0.47	1.43	2.12	1.40	292
	625	421	421	4	1.5	6 920	18 800	47T926342	1-P	495	607	582	8	3	1.5	0.33	2.03	3.02	1.98	386
	650	474	474	6	6	7 680	19 400	37292	1	500	622	598	8	5	5	0.33	2.03	3.02	1.98	495
	680	375	375	5	2	6 500	15 200	47T926838	1	515	658	618	10.5	4	2	0.36	1.87	2.79	1.83	475
	730	440	440	6	3	8 650	17 700	47T927344	1-P	519	702	662	13	5	2.5	0.47	1.43	2.12	1.40	710
475.000	600.000	368.000	368.000	4.8	1.6	4 970	15 100	47T956037A	1	501	581	566	10.5	4.8	1.6	0.26	2.55	3.80	2.50	246
479.425	679.450	495.300	495.300	6.4	3.2	9 660	25 400	47T966850	1-P	523	656	641	12.5	6.4	3.2	0.33	2.03	3.02	1.98	591
	679.450	495.300	495.300	6.4	3.2	8 480	22 200	M272749D/710/710D	1-P	524	656	627	7.5	6.4	3.2	0.33	2.03	3.02	1.98	575

[Note] 1) While metric series bearings have minus tolerances for bore and OD, inch series have plus tolerances. Refer to page 190 for details of applicable tolerance standards.

# Four-row tapered roller bearings

TQO type  
*d* 480 ~ (508.000) mm

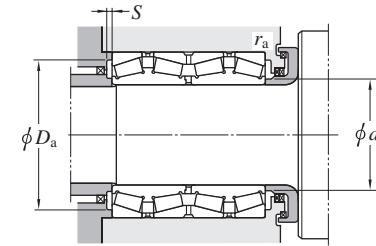
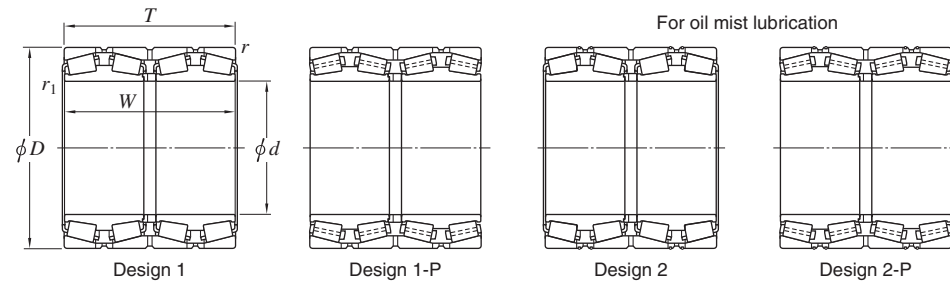

Boundary dimensions					Basic load ratings (kN)		Bearing No. <sup>1)</sup>	Design	Mounting dimensions (mm)						Constant <i>e</i>	Axial load factors			(Refer.) Mass (kg)					
<i>d</i> mm	<i>D</i> mm	<i>T</i> mm	<i>W</i> mm	<i>r</i> mm	<i>r</i> <sub>1 2)</sub> min. min.	<i>C<sub>r</sub></i>			<i>C<sub>Or</sub></i>	<i>d<sub>a</sub></i> max.	<i>D<sub>a</sub></i> max.	<i>S</i> min.	<i>r<sub>a</sub></i> min.	<i>r<sub>b</sub></i> max.		<i>e</i>	<i>Y<sub>2</sub></i>	<i>Y<sub>3</sub></i>		<i>Y<sub>0</sub></i>				
480	—	678	—	494	—	494	—	6	6	9 160	23 300	37296	1-P	520	650	629	9.5	5	5	0.33	2.03	3.02	1.98	563
	—	700	—	390	—	390	—	5	6	7 400	16 800			47T967039	1-P	536	678	647	11	4	6	0.33	2.03	3.02
480.000	18.8976	700.000	27.5591	420.000	16.5354	420.000	16.5354	6.4	3.2	8 060	18 800	47T967042C	1	531	677	644	10.5	6.4	3.2	0.35	1.95	2.90	1.91	540
482.600	19.0000	615.950	24.2500	330.200	13.0000	330.200	13.0000	6.4	6.4	4 830	13 400	47T976233	2-P	512	593	573	6	6.4	6.4	0.44	1.54	2.30	1.51	240
	19.0000	615.950	24.2500	330.200	13.0000	330.200	13.0000	6.4	6.4	4 830	13 400	4TR19A	1-P	512	593	573	6.5	6.4	6.4	0.44	1.54	2.30	1.51	240
	19.0000	615.950	24.2500	330.200	13.0000	330.200	13.0000	6.4	4.8	5 270	15 000	4TR19B	1-P	509	593	573	10.5	6.4	4.8	0.33	2.03	3.02	1.98	243
	19.0000	615.950	24.2500	330.200	13.0000	330.200	13.0000	6.4	3.2	5 210	15 000	4TR19D	1	508	593	573	10	6.4	3.2	0.36	1.87	2.79	1.83	240
	19.0000	615.950	24.2500	420.000	16.5354	420.000	16.5354	4	2.5	5 810	16 700	47T976242	1	508	597	577	6	4	2.5	0.26	2.55	3.80	2.50	296
	19.0000	647.700	25.5000	417.512	16.4375	417.512	16.4375	6.4	3.2	7 390	20 300	47T976542A	2-P	514	624	603	9.5	6.4	3.2	0.33	2.03	3.02	1.98	397
	19.0000	647.700	25.5000	417.512	16.4375	417.512	16.4375	6.4	3.2	7 390	20 300	M272647D/610/610D	1-P	514	624	604	9.5	6.4	3.2	0.33	2.03	3.02	1.98	395
	19.2500	622.300	24.5000	365.125	14.3750	365.125	14.3750	3.6	3.6	4 950	13 900	47T986236	1	516	605	585	7.5	3.6	3.6	0.33	2.03	3.02	1.98	262
19.2500	660.400	26.0000	361.950	14.2500	365.125	14.3750	6.4	7.9	6 200	15 800	EE640193D/260/261D	1-P	527	637	616	11	6.4	7.9	0.31	2.20	3.27	2.15	357	
489.026	19.2530	634.873	24.9950	320.675	12.6250	320.675	12.6250	3.2	3.2	4 520	13 200	EE243193D/250/251D	1	526	618	595	9.5	3.2	3.2	0.34	1.97	2.93	1.93	263
	19.2530	634.873	24.9950	320.675	12.6250	320.675	12.6250	3.2	3.2	4 930	13 700	LM772749D/710/710D	1	513	618	594	9.5	3.2	3.2	0.47	1.43	2.12	1.40	261
490	—	625	—	385	—	385	—	4	1.5	5 690	17 200	47T986339A	1	520	607	587	9.5	3	1.5	0.28	2.43	3.61	2.37	290
	—	625	—	385	—	385	—	4	1.5	5 540	16 600	47T986339B	1	517	607	587	4.5	3	1.5	0.32	2.12	3.15	2.07	285
500	—	640	—	450	—	450	—	4	1.5	7 050	20 300	4TR500M	2-P	527	622	602	10.5	3	1.5	0.24	2.84	4.23	2.78	352
	—	670	—	515	—	515	—	5	6	9 110	25 700	4TR500B	1-P	530	648	626	11	4	5	0.32	2.12	3.15	2.07	510
	—	705	—	515	—	515	—	6	SP	9 530	24 500	372/500	1-P	544	677	651	8.5	5	6	0.37	1.80	2.69	1.76	641
	—	710	—	430	—	425	—	5	3	8 170	20 000	4TR500T	1	547	688	658	12	4	3	0.37	1.80	2.69	1.76	528
	—	720	—	400	—	400	—	6	6	7 990	18 700	4TR500J	1-P	552	692	663	12.5	5	5	0.33	2.03	3.02	1.98	547
	—	760	—	420	—	420	—	2	6	8 730	19 300	4TR500Q	1-P	566	750	696	11.5	2	6	0.39	1.74	2.59	1.70	698
501.650	19.7500	673.100	26.5000	387.350	15.2500	400.050	15.7500	6.4	3.2	6 670	17 300	EE641198D/265/266D	1-P	538	650	628	9.5	6.4	3.2	0.31	2.15	3.20	2.10	386
	19.7500	711.200	28.0000	520.700	20.5000	520.700	20.5000	6.4	3.2	9 820	26 400	M274149D/110/110D	1-P	549	687	656	10.5	6.4	3.2	0.33	2.03	3.02	1.98	673
508.000	20.0000	716.000	28.1890	528.000	20.7874	528.000	20.7874	8	3.2	10 100	26 300	4TR508	1-P	549	689	664	9.5	8	3.2	0.35	1.95	2.90	1.91	679

[Notes] 1) While metric series bearings have minus tolerances for bore and OD, inch series have plus tolerances. Refer to page 190 for details of applicable tolerance standards.

2) SP indicates the specially chamfered form.

# Four-row tapered roller bearings

## TQO type

$d$  (508.000) ~ 558.750 mm

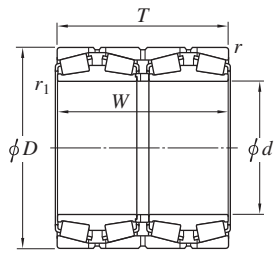

Design 1

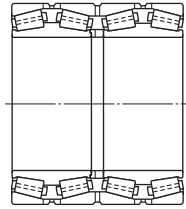

Design 1-P

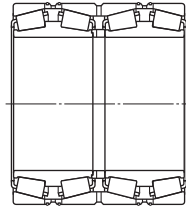

Design 2

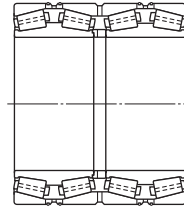

Design 2-P

For oil mist lubrication

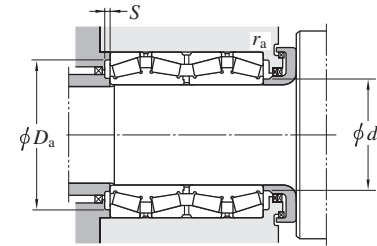

Boundary dimensions						Basic load ratings (kN)		Bearing No. <sup>1)</sup>	Design	Mounting dimensions (mm)						Constant $e$	Axial load factors			(Refer.) Mass (kg)
$d$	$D$	$T$	$W$	$r$	$r_1$ <sup>2)</sup>	$C_r$	$C_{Or}$			$d_a$	$D_a$	$S$	$r_a$	$r_b$	$Y_2$		$Y_3$	$Y_0$		
mm	mm	mm	mm	mm	mm			max.	max.	min.	min.	max.	max.							
508.000	762.000	463.550	463.550	6.4	6.4	9 060	19 900	EE531201D/300/301XD	1-P	564	738	696	11.5	6.4	6.4	0.38	1.78	2.65	1.74	736
509.948	654.924	379.000	377.000	6.4	1.6	5 780	16 700	4TR510A	1-P	534	632	612	7	6.4	1.6	0.41	1.64	2.44	1.60	315
510	655	379	377	5	2.5	6 540	18 600	4TR510L	1-P	540	633	613	9	4	2.5	0.26	2.55	3.80	2.50	320
	730	520	520	5	6	10 500	27 300	4TR510Q	1-P	559	708	674	13	4	6	0.33	2.03	3.02	1.98	728
514.350	673.100	422.275	422.275	6.4	3.2	7 190	20 100	4TR514A	1	545	650	630	11	6.4	3.2	0.33	2.03	3.02	1.98	392
	673.100	422.275	422.275	6.4	3.2	7 130	20 300	LM274449D/410/410D	1-P	547	650	630	9	6.4	3.2	0.33	2.03	3.02	1.98	399
519.113	736.600	536.575	536.575	6.4	3.2	10 600	27 200	M275349D/310/310D	1-P	562	712	681	10.5	6.4	3.2	0.33	2.03	3.02	1.98	743
520	735	535	535	5	2.5	10 600	27 200	4TR520	1-P	564	713	681	11.5	4	2.5	0.33	2.03	3.02	1.98	726
520.700	711.200	400.050	400.050	6.4	3.2	7 000	17 500	LM275349D/10/10D	1-P	562	687	663	7	6.4	3.2	0.33	2.03	3.02	1.98	438
530	730	540	535	5	SP	10 200	27 900	4TR530-1	1-P	570	708	677	9	4	3	0.34	1.96	2.92	1.92	686
	730	540	535	4	SP	9 460	25 000	4TR530-2	1	567	712	677	6	3	3	0.34	1.96	2.92	1.92	669
	750	480	480	6	6	9 930	24 700	4TR530B	1-P	584	722	695	11.5	5	5	0.32	2.12	3.15	2.07	680
	750	480	480	5	2	9 630	24 100	4TR530C	1	579	728	695	9.5	4	2	0.32	2.12	3.15	2.07	673
535	750	560	560	5	6	11 100	29 400	4TR535	1-P	579	728	695	10.5	4	5	0.33	2.02	3.01	1.98	761
	760	560	560	6	6	11 300	28 800	372/535	1-P	587	732	703	10	5	5	0.33	2.02	3.01	1.98	815
536.575	761.873	558.800	558.800	6.4	3.2	11 300	28 800	M276449D/410/410D	1-P	578	738	700	9	6.4	3.2	0.33	2.03	3.02	1.98	820
540	690	400	400	5	2.5	6 710	19 800	4TR540	1-P	566	668	648	10.5	4	2	0.40	1.68	2.50	1.64	369
	760	560	560	5	6	11 400	30 600	4TR540A	1-P	587	738	704	10.5	4	6	0.33	2.03	3.02	1.98	808
550	685	350	350	4	1.5	5 280	16 100	4TR550C	1	579	667	647	8	3	1.5	0.29	2.32	3.45	2.26	287
555.625	698.500	349.250	349.250	6.4	3.2	5 710	17 000	4TR555	1-P	586	675	655	9.5	6.4	3.2	0.33	2.03	3.02	1.98	312
558.750	965.300	495.300	495.300	7.5	7.5	12 500	25 700	4TR559B	1-P	685	934	855	11.5	7.5	7.5	0.33	2.03	3.02	1.98	1 570

[Notes] 1) While metric series bearings have minus tolerances for bore and OD, inch series have plus tolerances. Refer to page 190 for details of applicable tolerance standards.

2) SP indicates the specially chamfered form.

## Four-row tapered roller bearings

### TQO type

d 558.800 ~ 609.600 mm

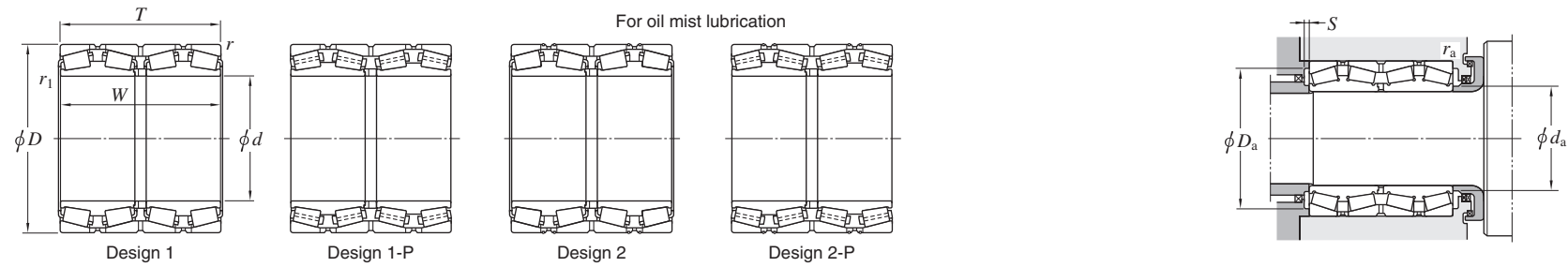

Boundary dimensions						Basic load ratings (kN)		Bearing No. 1)	Design	Mounting dimensions (mm)						Constant e	Axial load factors			(Refer.) Mass (kg)				
d	D	T	W	r	r1	Cr	Cor			da	Da	S	ra	rb	Y2		Y3	Y0						
mm	1/25.4	mm	1/25.4	mm	1/25.4	min.	min.	max.	max.	min.	min.	max.	max.											
558.800	22.0000	736.600	29.0000	409.575	16.1250	409.575	16.1250	6.4	3.2	7 660	21 500	4TR559N	1-P	594	712	689	10.5	6.4	3.2	0.35	1.95	2.90	1.91	477
	22.0000	736.600	29.0000	322.263	12.6875	322.263	12.6875	6.4	3.2	5 920	16 100	EE843221D/290/291D	1-P	607	712	692	9.5	6.4	3.2	0.34	1.97	2.93	1.93	371
	22.0000	736.600	29.0000	409.575	16.1250	409.575	16.1250	6.4	3.2	6 920	18 800	4TR559J	1	598	712	691	10	6.4	3.2	0.35	1.95	2.90	1.91	463
	22.0000	736.600	29.0000	430.000	16.9291	430.000	16.9291	6.4	3.2	8 070	22 200	4TR559	1	593	712	690	12	6.4	3.2	0.35	1.95	2.90	1.91	497
	22.0000	736.600	29.0000	450.000	17.7165	450.000	17.7165	4	3	8 220	23 100	4TR559A	1-P	594	717	692	9	4	3	0.35	1.95	2.90	1.91	525
	22.0000	736.600	29.0000	457.200	18.0000	455.612	17.9375	6.4	3.2	8 990	25 500	LM277149DA/110/110D	1-P	595	712	692	11.5	6.4	3.2	0.33	2.03	3.02	1.98	521
	22.0000	736.600	29.0000	457.200	18.0000	455.612	17.9375	6.4	3.2	8 990	25 500	LM277149DA/110/110D	1-P	595	712	692	11.5	6.4	3.2	0.33	2.03	3.02	1.98	521
560	—	805	—	590	—	590	—	6	6	13 000	33 700	372/560	1-P	614	777	744	10.5	5	5	0.33	2.03	3.02	1.98	1 000
	—	920	—	620	—	620	—	7.5	7.5	15 200	32 800	4TR560	1-P	643	884	823	12	6	6	0.40	1.68	2.50	1.64	1 650
570	—	780	—	515	—	515	—	5	2.5	10 100	27 400	4TR570A	1-P	618	758	726	10	4	2	0.42	1.61	2.39	1.57	737
	—	810	—	590	—	590	—	5	2	13 000	35 000	4TR570C	1-P	625	788	751	14	4	2	0.33	2.03	3.02	1.98	1 000
571.500	22.5000	812.800	32.0000	593.725	23.3750	593.725	23.3750	6.4	3.2	13 000	35 000	4TR572	2-P	625	789	751	13	6.4	3.2	0.33	2.03	3.02	1.98	1 020
	22.5000	812.800	32.0000	593.725	23.3750	593.725	23.3750	6.4	3.2	13 000	35 000	M278749D/710/710D	1-P	625	789	751	14	6.4	3.2	0.33	2.03	3.02	1.98	1 020
580	—	770	—	510	—	510	—	4	1.5	10 300	29 600	4TR580	1-P	618	752	723	12	3	1.5	0.33	2.03	3.02	1.98	671
584.200	23.0000	730.250	28.7500	349.250	13.7500	342.900	13.5000	3.2	1.6	5 580	17 300	4TR584	1-P	613	712	692	6.5	3.2	1.6	0.43	1.57	2.34	1.53	326
	23.0000	762.000	30.0000	401.638	15.8125	396.875	15.6250	6.4	3.2	7 330	20 800	LM778549D/510/510D	1-P	617	738	715	8.5	6.4	3.2	0.47	1.43	2.12	1.40	468
585.788	23.0625	771.525	30.3750	479.425	18.8750	479.425	18.8750	6.4	3.2	9 140	25 600	LM278849D/810/810D	1-P	622	747	725	11	6.4	3.2	0.33	2.03	3.02	1.98	599
595.312	23.4375	844.550	33.2500	615.950	24.2500	615.950	24.2500	6.4	3.2	13 600	36 900	M280049D/010/010D	1-P	651	820	780	8	6.4	3.2	0.33	2.03	3.02	1.98	1 130
600	—	855	—	620	—	620	—	5	6	14 000	37 900	4TR600B	1-P	658	833	792	13	4	5	0.33	2.03	3.02	1.98	1 160
603.250	23.7500	857.250	33.7500	622.300	24.5000	622.300	24.5000	6.4	3.2	14 500	38 500	M280249D/210/210XD	1-P	652	833	788	12	6.4	3.2	0.33	2.03	3.02	1.98	1 170
609.600	24.0000	787.400	31.0000	361.950	14.2500	361.950	14.2500	6.4	3.2	6 790	19 900	4TR610A	2-P	650	763	739	13	6.4	3.2	0.37	1.82	2.70	1.78	455
	24.0000	787.400	31.0000	361.950	14.2500	361.950	14.2500	6.4	3.2	6 790	19 900	EE649241D/310/311D	1-P	650	763	739	13	6.4	3.2	0.37	1.82	2.70	1.78	459
	24.0000	813.562	32.0300	479.425	18.8750	479.425	18.8750	6.4	3.2	9 350	27 100	4TR609	1-P	657	789	759	9	6.4	3.2	0.33	2.03	3.02	1.98	710
	24.0000	817.400	32.1811	361.950	14.2500	361.950	14.2500	6.4	3.2	7 310	18 200	4TR610	1-P	660	793	766	7	6.4	3.2	0.33	2.03	3.02	1.98	531

[Note] 1) While metric series bearings have minus tolerances for bore and OD, inch series have plus tolerances. Refer to page 190 for details of applicable tolerance standards.

# Four-row tapered roller bearings

## TQO type

d 620 ~ 680 mm

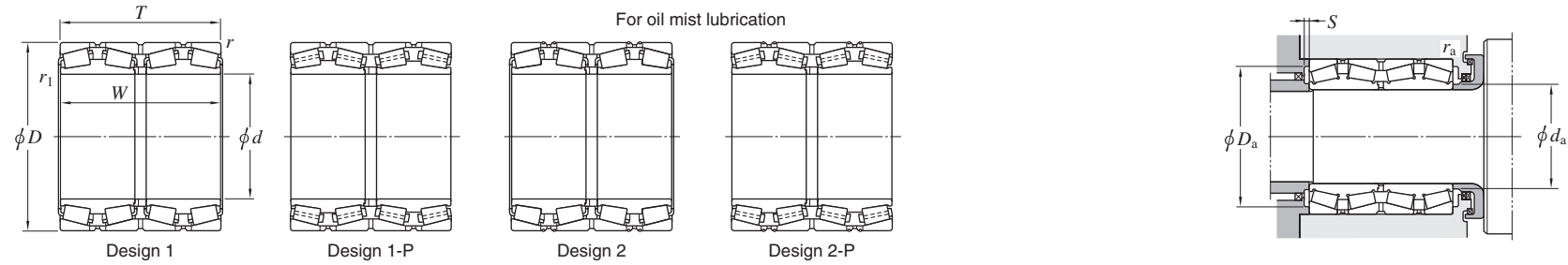

Boundary dimensions						Basic load ratings (kN)		Bearing No. <sup>1)</sup>	Design	Mounting dimensions (mm)						Constant e	Axial load factors			(Refer.) Mass (kg)
d	D	T	W	r	r <sub>1</sub>	C <sub>r</sub>	C <sub>0r</sub>			d <sub>a</sub>	D <sub>a</sub>	S	r <sub>a</sub>	r <sub>b</sub>	Y <sub>2</sub>		Y <sub>3</sub>	Y <sub>0</sub>		
mm	mm	mm	mm	mm	mm			max.	max.	min.	min.	max.	max.							
620	800	365	365	5	2.5	7 590	21 000	661	778	756	14	4	2	0.32	2.12	3.15	2.07	474		
630	920	457.15	457.15	6	3	11 500	26 200	698	892	846	11.5	5	2.5	0.33	2.03	3.02	1.98	1 050		
635	900	660	660	6	6	15 000	39 700	690	872	832	7	5	5	0.33	2.03	3.02	1.98	1 350		
635.000	901.700	654.050	654.050	6.4	3.2	15 000	39 700	691	877	833	7	6.4	3.2	0.33	2.03	3.02	1.98	1 360		
646.112	857.250	542.925	542.925	6.4	3.2	11 400	34 100	690	833	801	13	6.4	3.2	0.33	2.03	3.02	1.98	881		
649.924	914.898	674.000	672.000	6	3.6	15 900	43 800	703	891	844	12	6	3.6	0.33	2.03	3.02	1.98	1 430		
650	1 030	558.5	558.5	12	7.5	15 900	36 200	749	986	925	10.5	10	6	0.32	2.12	3.15	2.07	1 850		
657.225	933.450	676.275	676.275	6.4	3.3	17 300	46 000	713	909	864	9.5	6.4	3.3	0.33	2.03	3.02	1.98	1 530		
659.924	854.924	318.480	318.480	9.5	4.8	6 240	16 000	700	820	800	8	9.5	4.8	0.35	1.92	2.86	1.88	462		
660	855	320	320	4	5	6 320	18 000	705	837	799	11.5	3	4	0.47	1.43	2.12	1.40	481		
660.400	812.800	365.125	365.125	6.4	3.2	6 860	21 100	691	789	775	8	6.4	3.2	0.33	2.03	3.02	1.98	402		
	812.800	365.125	365.125	6.4	3.2	6 860	21 100	691	789	775	8	6.4	3.2	0.33	2.03	3.02	1.98	405		
670	960	700	700	7.5	5	17 800	48 100	732	924	884	13	6	4	0.33	2.03	3.02	1.98	1 710		
676	910	620	620	5	2	14 600	43 300	724	888	849	13.5	4	2	0.33	2.03	3.02	1.98	1 180		
679.450	901.700	552.450	552.450	6.4	3.2	12 800	36 100	724	877	847	11.5	6.4	3.2	0.33	2.03	3.02	1.98	973		
680	870	460	460	4	2.5	9 060	27 400	710	852	820	9	3	2.5	0.50	1.34	2.00	1.32	677		
680.000	970.000	740.000	740.000	6.4	3.2	18 800	52 800	743	946	896	9	6.4	3.2	0.33	2.03	3.02	1.98	1 790		
680	1 020	555	555	6	3	15 300	36 700	771	992	934	14.5	5	2.5	0.32	2.12	3.15	2.07	1 650		

[Note] 1) While metric series bearings have minus tolerances for bore and OD, inch series have plus tolerances. Refer to page 190 for details of applicable tolerance standards.

# Four-row tapered roller bearings

## TQO type

$d$  685.800 ~ 825.500 mm

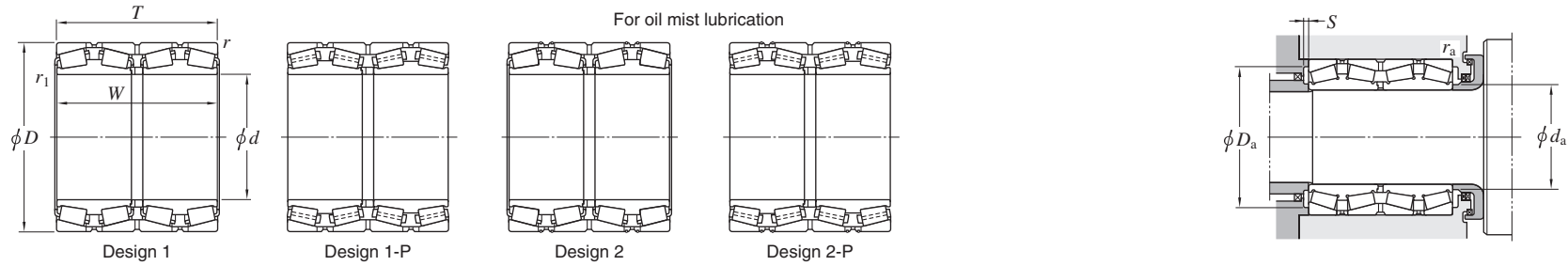

Boundary dimensions						Basic load ratings (kN)		Bearing No. 1)	Design	Mounting dimensions (mm)						Constant $e$	Axial load factors			(Refer.) Mass (kg)				
$d$ mm	$D$ mm	$T$ mm	$W$ mm	$r$ min.	$r_{12)}$ min.	$C_r$	$C_{Or}$			$d_a$ max.	$D_a$ max.	$S$ min.	$r_a$ max.	$r_b$ max.	$e$		$Y_2$	$Y_3$	$Y_0$					
685.800	27.0000	876.300	34.5000	355.600	14.0000	352.425	13.8750	6.4	3.2	7 390	23 100	<b>4TR686A</b>	1-P	734	852	824	11	6.4	3.2	0.42	1.62	2.42	1.59	554
	27.0000	876.300	34.5000	355.600	14.0000	352.425	13.8750	6.4	3.2	7 390	23 100	<b>4TR686D</b>	2-P	734	852	823	11	6.4	3.2	0.42	1.62	2.42	1.59	555
708.025	27.8750	930.275	36.6250	565.150	22.2500	565.150	22.2500	6.4	3.2	13 800	40 300	<b>4TR708B</b>	1-P	753	906	878	11	6.4	3.2	0.33	2.03	3.02	1.98	1 050
710.000	27.9528	900.000	35.4331	410.000	16.1417	410.000	16.1417	6	3	9 190	27 300	<b>4TR710</b>	1-P	750	877	853	11.5	6	2.5	0.35	1.95	2.90	1.91	636
711.200	28.0000	914.400	36.0000	317.500	12.5000	317.500	12.5000	6.4	6.4	6 810	18 800	<b>4TR711</b>	1-P	774	890	868	11.5	6.4	6.4	0.38	1.78	2.65	1.74	538
	28.0000	914.400	36.0000	355.600	14.0000	355.600	14.0000	6.4	3.2	7 850	21 200	<b>47T1429136</b>	1-P	753	890	860	10.5	6.4	3.2	0.38	1.78	2.65	1.74	598
714.375	28.1250	1 016.000	40.0000	704.850	27.7500	704.850	27.7500	6.4	3.2	19 500	52 200	<b>M383240D/210/210D</b>	1-P	776	992	940	14.5	6.4	3.2	0.35	1.92	2.86	1.88	1 900
717.550	28.2500	946.150	37.2500	565.150	22.2500	565.150	22.2500	6.4	3.2	13 600	39 500	<b>LM282847D/810/810D</b>	1-P	764	922	890	12.5	6.4	3.2	0.33	2.03	3.02	1.98	1 090
730	—	1 035	—	755	—	755	—	5	2.5	19 600	54 300	<b>4TR730</b>	1-P	795	1 013	955	11	4	2	0.33	2.03	3.02	1.98	2 080
730.250	28.7500	1 035.050	40.7500	755.650	29.7500	755.650	29.7500	6.4	3.2	19 600	54 300	<b>M283449D/410/410D</b>	1-P	795	1 011	955	11	6.4	3.2	0.33	2.03	3.02	1.98	2 080
749.300	29.5000	990.600	39.0000	605.000	23.8189	605.000	23.8189	6.4	3.2	15 700	47 700	<b>LM283649D/610/610D</b>	1-P	801	966	929	13	6.4	3.2	0.32	2.12	3.15	2.07	1 320
750.000	29.5276	950.000	37.4016	410.000	16.1417	410.000	16.1417	4	2.5	9 700	29 000	<b>4TR750</b>	1-P	791	929	900	11.5	4	2	0.40	1.68	2.50	1.68	705
750	—	1 130	—	690	—	690	—	7.5	7.5	19 500	45 800	<b>4TR750A</b>	1-P	821	1 094	1 023	13	6	6	0.46	1.47	2.19	1.44	2 500
760	—	1 080	—	630	—	630	—	6	3	17 800	46 300	<b>4TR760</b>	1-P	829	1 052	999	17.5	5	2.5	0.40	1.68	2.50	1.64	1 900
	30.0000	1 066.800	42.0000	736.600	29.0000	723.900	28.5000	12.7	SP	19 900	55 900	<b>4TR762</b>	1-P	829	1 030	986	6	12.7	6.4	0.33	2.03	3.02	1.98	2 070
762.000	30.0000	1 079.500	42.5000	787.400	31.0000	787.400	31.0000	12.7	4.8	22 200	62 700	<b>M284249D/210/210XD</b>	1-P	831	1 043	998	11	12.7	4.8	0.33	2.03	3.02	1.98	2 360
785.000	30.9055	1 040.000	40.9449	560.000	22.0472	560.000	22.0472	7.5	5	15 300	44 400	<b>4TR785B</b>	1-P	846	1 009	978	13	7.5	5	0.26	2.55	3.80	2.50	1 340
800	—	1 120	—	820	—	820	—	7.5	6	24 100	70 200	<b>4TR800</b>	1-P	869	1 084	1 038	13.5	6	5	0.33	2.03	3.02	1.98	2 590
825.500	32.5000	1 168.400	46.0000	844.550	33.2500	844.550	33.2500	12.7	4.8	26 000	72 300	<b>M285848D/10/10D</b>	1-P	897	1 132	1 083	15.5	12.7	4.8	0.33	2.03	3.02	1.98	2 980

[Notes] 1) While metric series bearings have minus tolerances for bore and OD, inch series have plus tolerances. Refer to page 190 for details of applicable tolerance standards.

2) SP indicates the specially chamfered form.

# Four-row tapered roller bearings

## TQO type

$d$  840 ~ 1 020 mm

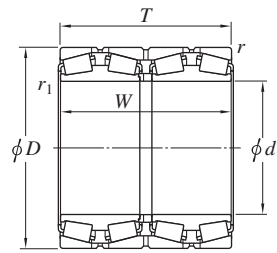

Design 1

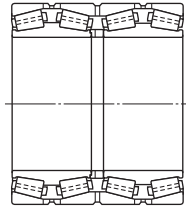

Design 1-P

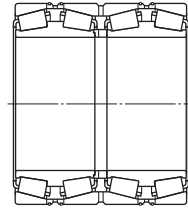

Design 2

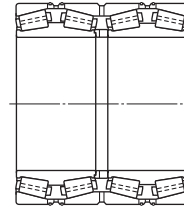

Design 2-P

For oil mist lubrication

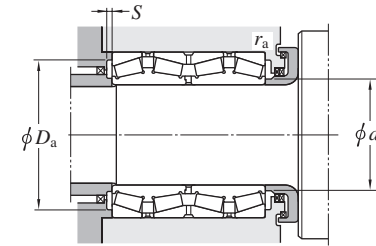

Boundary dimensions						Basic load ratings (kN)		Bearing No. <sup>1)</sup>	Design	Mounting dimensions (mm)						Constant $e$	Axial load factors			(Refer.) Mass (kg)				
$d$ mm	$D$ mm	$T$ mm	$W$ mm	$r$ min.	$r_1$ min.	$C_r$	$C_{Or}$			$d_a$ max.	$D_a$ max.	$S$ min.	$r_a$ max.	$r_b$ max.	$Y_2$		$Y_3$	$Y_0$						
<b>840</b>	—	1 170	—	840	—	840	—	7.5	7.5	25 600	74 600	<b>4TR840</b>	1-P	911	1 134	1 089	16	6	6	0.33	2.03	3.02	1.98	2 880
<b>863.600</b>	34.0000	1 130.300	44.5000	669.925	26.3750	669.925	26.3750	12.7	4.8	19 100	59 600	<b>LM286249D/210/210D</b>	1-P	920	1 093	1 063	15	12.7	4.8	0.32	2.08	3.10	2.04	1 840
	34.0000	1 219.200	48.0000	889.000	35.0000	876.300	34.5000	12.7	4.8	28 500	84 600	<b>EE547341D/480/481D</b>	1-P	947	1 182	1 130	9	12.7	4.8	0.33	2.03	3.02	1.98	3 390
<b>938.213</b>	36.9375	1 270.000	50.0000	825.500	32.5000	825.500	32.5000	12.7	4.8	26 800	79 800	<b>LM287649D/610/610D</b>	1-P	1 007	1 233	1 187	17.5	12.7	4.8	0.33	2.03	3.02	1.98	3 130
<b>939.800</b>	37.0000	1 333.500	52.5000	952.500	37.5000	952.500	37.5000	12.7	4.8	33 500	95 400	<b>LM287849D/810/810D</b>	1-P	1 022	1 297	1 235	15.5	12.7	4.8	0.33	2.03	3.02	1.98	4 380
<b>1 020</b>	—	1 570	—	900	—	900	—	7.5	7.5	36 500	98 800	<b>4TR1020</b>	1-P	1 172	1 534	1 413	21	6	6	0.33	2.03	3.02	1.98	6 890

[Note] 1) While metric series bearings have minus tolerances for bore and OD, inch series have plus tolerances. Refer to page 190 for details of applicable tolerance standards.



# Four-row tapered roller bearings

## 45D type

$d$  346.075 ~ 509.948 mm

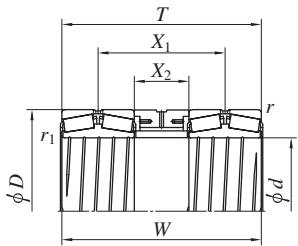

Design 1

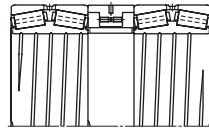

Design 1-P

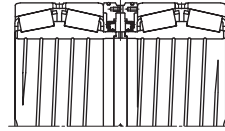

Design 2

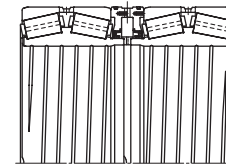

Design 2-P

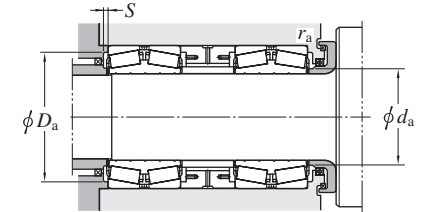

Boundary dimensions											Basic load ratings (kN)		Bearing No. <sup>1)</sup>	Design	Mounting dimensions (mm)						Constant $e$	Axial load factors			(Refer.) Mass (kg)
$d$ mm	$D$ mm	$T$ mm	$W$ mm	$X_1$ mm	$X_2$ mm	$r^{2)}$ min.	$r_1^{2)}$ min.	$C_r$	$C_{0r}$	$d_a$ max.	$D_a$ max.	$S$ min.			$r_a$ max.	$r_b$ max.	$Y_2$	$Y_3$	$Y_0$						
346.075	488.950	417.000	417.000	242.375	67.750	3.2	3.2	4 620	11 600	378	478	449	8	3.2	3.2	0.33	2.02	3	1.97	240					
360	450	350	350	225	100	2	1.5	2 660	7 460	380	440	425	5.5	2	1.5	0.29	2.32	3.45	2.26	109					
380	530	540	540	340	140	4	3	5 510	13 800	412	512	488	11	3	2.5	0.26	2.55	3.8	2.5	323					
384.175	546.100	514.350	514.350	320.675	127.000	6.4	3.2	6 530	16 900	418	529	502	10.5	6.4	3.2	0.33	2.03	3.02	1.98	386					
385.762	514.350	317.500	317.500	164.500	11.500	3.2	3.2	4 380	11 000	415	503	483	9	3.2	3.2	0.26	2.55	3.8	2.5	180					
400	530	370	370	202	34	3	1	4 930	12 900	428	516	497	11.5	2.5	1	0.26	2.55	3.8	2.5	213					
406.400	562.000	381.000	381.000	196.924	12.700	6.4	3.2	5 990	15 000	439	545	524	9.5	6.4	3.2	0.33	2.03	3.02	1.98	286					
409.575	540.000	410.000	410.000	235.000	60.000	3	2	5 030	14 000	439	528	507	11	3	2	0.26	2.55	3.8	2.5	255					
	546.100	400.000	400.000	238.075	76.150	6.4	1.6	4 570	11 500	432	529	511	8.5	6.4	1.6	0.42	1.62	2.42	1.59	228					
430	575	500	500	295	90	SP	2	5 670	14 900	460	575	539	4.5	5	2	0.26	2.55	3.8	2.5	350					
431.800	571.500	400.000	400.000	238.075	76.150	6.4	3	4 790	12 500	460	554	536	10.5	6.4	3	0.36	1.87	2.79	1.83	281					
460	586	500	500	325	150	3	3	5 300	15 500	487	572	555	11.5	2.5	2.5	0.26	2.55	3.8	2.5	319					
	680	390	390	225	60	5	1.5	6 020	13 700	518	658	619	11.5	4	1.5	0.36	1.87	2.79	1.83	429					
480	700	470	470	267	64	5	1.5	8 060	18 800	531	678	644	11	4	1.5	0.35	1.95	2.9	1.91	599					
482	632	520	520	320	120	1.5	1.5	6 840	18 800	510	623.5	593	7	2	1.5	0.26	2.55	3.8	2.5	416					
482.600	615.950	425.000	425.000	237.000	49.000	4	1.5	5 810	16 700	510	601	585	11	4	1.5	0.26	2.55	3.8	2.5	292					
	615.950	488.750	488.750	300.750	112.750	4	SP	5 810	16 700	500	601	585	11	4	2	0.26	2.55	3.8	2.5	329					
	615.950	500.000	500.000	314.250	182.500	6.4	6.4	4 830	13 400	512	599	583	6.5	6.4	6.4	0.44	1.54	2.3	1.51	358					
486	654.924	500	500	315.5	131	3	3	6 560	17 000	523	640	610	11	2.5	2.5	0.28	2.43	3.61	2.37	455					
509.948	654.924	500.000	500.000	310.000	120.000	3	1.5	6 450	19 000	539	642	617	10	3	1.5	0.28	2.43	3.61	2.37	405					

[Notes] 1) While metric series bearings have minus tolerances for bore and OD, inch series have plus tolerances. Refer to page 190 for details of applicable tolerance standards.

2) SP indicates the specially chamfered form.

# Four-row tapered roller bearings

## 45D type

$d$  510 ~ 685.800 mm

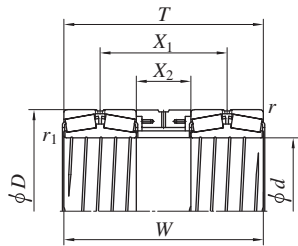

Design 1

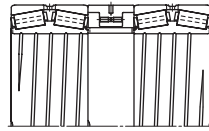

Design 1-P

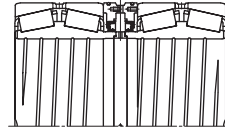

Design 2

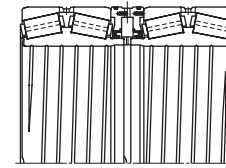

Design 2-P

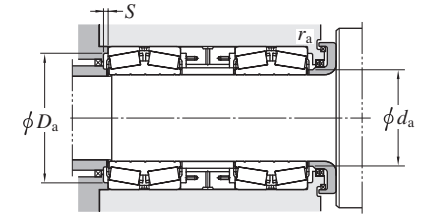

Boundary dimensions											Basic load ratings (kN)		Bearing No. <sup>1)</sup>	Design	Mounting dimensions (mm)						Con- stant $e$	Axial load factors			(Refer.) Mass (kg)
$d$ mm	$D$ mm	$T$ mm	$W$ mm	$X_1$ mm	$X_2$ mm	$r^{2)}$ min.	$r_1$ min.	$C_r$	$C_{0r}$	$d_a$ max.	$D_a$ max.	$S$ min.			$r_a^{2)}$ max.	$r_b$ max.	$e$	$Y_2$	$Y_3$	$Y_0$					
510	655	379	377	199.5	12	5	2	6 540	18 600	4TR510L-2	1-P	540	633	619	9	4	2	0.26	2.55	3.8	2.5	320			
558.800	736.600	514.000	514.000	293.337	72.674	6.4	3.2	8 990	25 500	4TR559P-1	1-P	595	719	693	11.5	6.4	3.2	0.33	2.03	3.02	1.98	576			
609.600	813.562	548.000	548.000	317.000	86.000	SP	6.4	10 200	28 500	4TR610D	2-P	653	792	764	11.5	SP	6.4	0.33	2.03	3.02	1.98	776			
685.800	876.300	580.000	580.000	340.000	100.000	6.4	3.2	11 000	34 900	4TR686J	1-P	730	859	829	14	6.4	3.2	0.26	2.55	3.8	2.5	875			

[Notes] 1) While metric series bearings have minus tolerances for bore and OD, inch series have plus tolerances. Refer to page 190 for details of applicable tolerance standards.

2) SP indicates the specially chamfered form.

# Sealed type four-row tapered roller bearings

$d$  75 ~ 234.950 mm

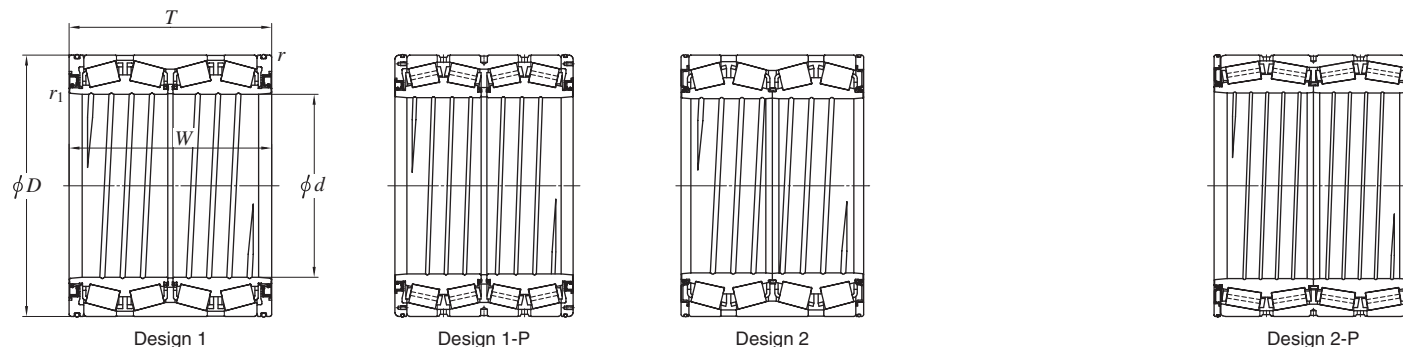

Boundary dimensions								Basic load ratings (kN)		Bearing No.	Design	Constant $e$	Axial load factors		(Refer.) Mass (kg)		
$d$ mm	$D$ mm	$T$ mm	$W$ mm	$r_1^{1)}$ min.	$r_1^{1)}$ min.	$C_r$	$C_{Or}$	$Y_2$	$Y_3$								
75	—	120	—	150	—	150	—	2	1	424	764	1	0.33	2.03	3.02	6.4	
	—	135	—	180	—	187	—	1.5	1.5	455	776		1	0.87	0.78	1.16	10.7
140	—	198	—	174	—	174	—	4	1	803	1 630	1	0.47	1.43	2.12	16.3	
150	—	210	—	240	—	240	—	1.5	0.5	993	2 270	1	0.39	1.74	2.59	23.5	
170	—	240	—	175	—	175	—	2.5	1.5	980	1 990	1	0.26	2.55	3.8	23.9	
	—	250	—	230	—	230	—	2.5	1.5	1 370	2 860		1	0.26	2.55	3.8	37.7
190.500	7.5000	266.700	10.5000	188.913	7.4375	187.325	7.3750	3.2	1	1 060	2 270	1	0.46	1.47	2.19	27.6	
195	—	270	—	250	—	250	—	2.5	1	1 420	3 550	1	0.4	1.68	2.5	43.6	
200	—	300	—	300	—	300	—	4	1.6	2 260	4 900	1	0.26	2.55	3.8	73.5	
203.200	8.0000	317.500	12.5000	266.700	10.5000	266.700	10.5000	5	1.6	2 060	4 010	1	0.4	1.68	2.5	76.8	
206.375	8.1250	282.575	11.1250	190.500	7.5000	190.500	7.5000	3.2	1	1 100	2 240	1	0.51	1.33	1.97	33.5	
	8.1250	282.575	11.1250	240.000	9.4488	210.000	8.2677	3	1	1 450	3 380		1	0.43	1.57	2.34	39.6
215.900	8.5000	288.925	11.3750	177.800	7.0000	177.800	7.0000	3.2	1	1 060	2 350	1	0.4	1.68	2.5	30.6	
220	—	295	—	315	—	315	—	SP	SP	1 540	3 910	1	0.4	1.68	2.5	55.8	
	—	320	—	290	—	290	—	3	2	2 200	4 700		1	0.39	1.74	2.59	73.9
	—	330	—	260	—	260	—	5	2.5	2 100	4 220		1	0.4	1.68	2.5	79.5
220.663	8.6875	314.325	12.3750	239.713	9.4375	239.713	9.4375	3.2	3	1 680	3 410	1	0.33	2.03	3.02	51.9	
	8.6875	314.325	12.3750	330.000	12.9921	330.000	12.9921	3.2	3	2 360	5 650		1	0.26	2.55	3.8	79.2
225	—	320	—	230	—	230	—	3	1.5	1 630	3 350	1	0.47	1.43	2.12	56.9	
228.600	9.0000	311.150	12.2500	200.025	7.8750	200.025	7.8750	3.2	SP	1 330	2 850	1	0.4	1.68	2.5	41.3	
234.950	9.2500	327.025	12.8750	196.850	7.7500	196.850	7.7500	3.2	1	1 490	3 310	2	0.4	1.68	2.5	48.1	

[Note] 1) SP indicates the specially chamfered form.

# Sealed type four-row tapered roller bearings

$d$  240 ~ 279.578 mm

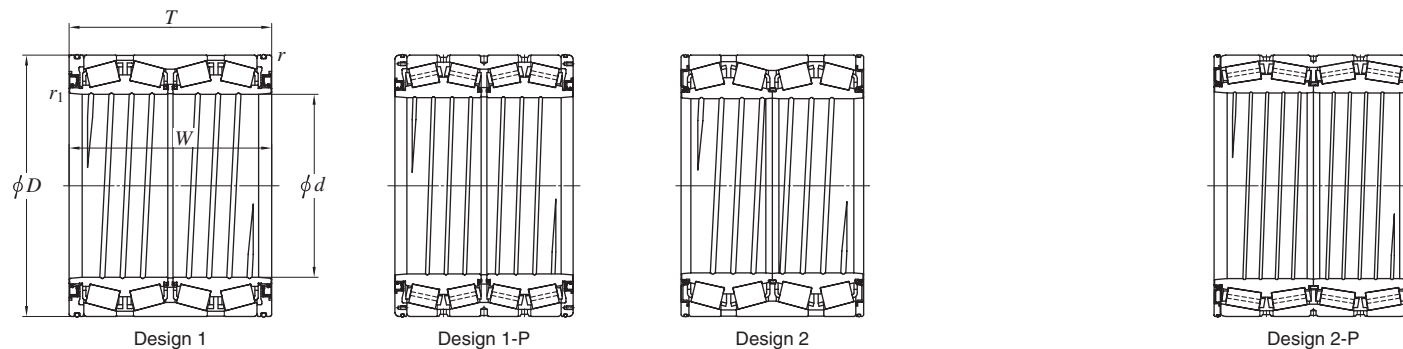

Boundary dimensions								Basic load ratings (kN)		Bearing No.	Design	Constant $e$	Axial load factors		(Refer.) Mass (kg)		
$d$ mm	$D$ mm	$T$ mm	$W$ mm	$r$ min.	$r_1$ <sup>1)</sup> min.	$C_r$	$C_{0r}$	$Y_2$	$Y_3$								
<b>240</b>	—	320	—	294	—	294	—	4	1	1 880	4 760	1	0.33	2.03	3.02	63.6	
	—	338	—	248	—	248	—	3	1.5	1 890	4 120		1	0.47	1.43	2.12	66
	—	338	—	290	—	290	—	3	1	2 360	5 360		1	0.39	1.74	2.59	78
	—	338	—	320	—	320	—	3	1	2 430	5 890		1	0.28	2.43	3.61	87.3
	—	338	—	340	—	340	—	3	1	2 450	5 930		1	0.4	1.68	2.5	88
<b>241.478</b>	9.5070	349.148	13.7460	228.600	9.0000	228.600	9.0000	3.2	SP	2 000	4 110	2	0.35	1.91	2.84	67.5	
<b>244.475</b>	9.6250	327.025	12.8750	193.675	7.6250	193.675	7.6250	5	1.5	1 280	2 790	1	0.33	2.03	3.02	41.5	
	9.6250	381.000	15.0000	304.800	12.0000	304.800	12.0000	5	1.6	2 700	5 240	1	0.47	1.43	2.12	124	
<b>245</b>	—	345	—	310	—	310	—	3	1.5	2 520	6 020	1	0.4	1.68	2.5	89.9	
<b>250</b>	—	365	—	270	—	270	—	3	1.5	2 260	4 730	1	0.4	1.68	2.5	94.2	
<b>254.000</b>	10.0000	358.775	14.1250	269.875	10.6250	269.875	10.6250	3.2	1.6	2 130	4 760	1	0.55	1.24	1.84	82	
	10.0000	358.775	14.1250	269.875	10.6250	269.875	10.6250	3.2	1.5	2 520	6 010	2	0.4	1.68	2.5	85	
<b>260</b>	—	365	—	340	—	340	—	3.5	1.6	2 800	6 530	1	0.4	1.68	2.5	110	
	—	370	—	354	—	354	—	4	1.5	3 100	7 410	1	0.26	2.55	3.8	120	
<b>266.700</b>	10.5000	355.600	14.0000	228.600	9.0000	230.188	9.0625	3.2	1.6	1 940	4 880	2	0.36	1.87	2.79	60	
<b>275</b>	—	385	—	340	—	340	—	3	1.5	2 970	7 400	1	0.4	1.68	2.5	121	
<b>276.225</b>	10.8750	393.700	15.5000	269.875	10.6250	269.875	10.6250	3.2	1.6	2 350	5 040	1	0.47	1.43	2.12	100	
	10.8750	393.700	15.5000	269.875	10.6250	269.875	10.6250	3.2	SP	2 770	6 510	2	0.4	1.68	2.5	105	
<b>279.400</b>	11.0000	393.700	15.5000	269.875	10.6250	269.875	10.6250	3.2	1.6	2 350	5 040	1	0.47	1.43	2.12	99.5	
	11.0000	393.700	15.5000	269.875	10.6250	269.875	10.6250	3.2	SP	2 770	6 510	2	0.4	1.68	2.5	101	
	11.0000	393.700	15.5000	320.000	12.5984	320.000	12.5984	3.2	1.5	2 880	6 900	1	0.4	1.68	2.5	124	
<b>279.578</b>	11.0070	380.898	14.9960	244.475	9.6250	244.475	9.6250	3.2	SP	2 270	5 360	2	0.4	1.68	2.5	78.3	

[Note] 1) SP indicates the specially chamfered form.

# Sealed type four-row tapered roller bearings

$d$  280 ~ 317.500 mm

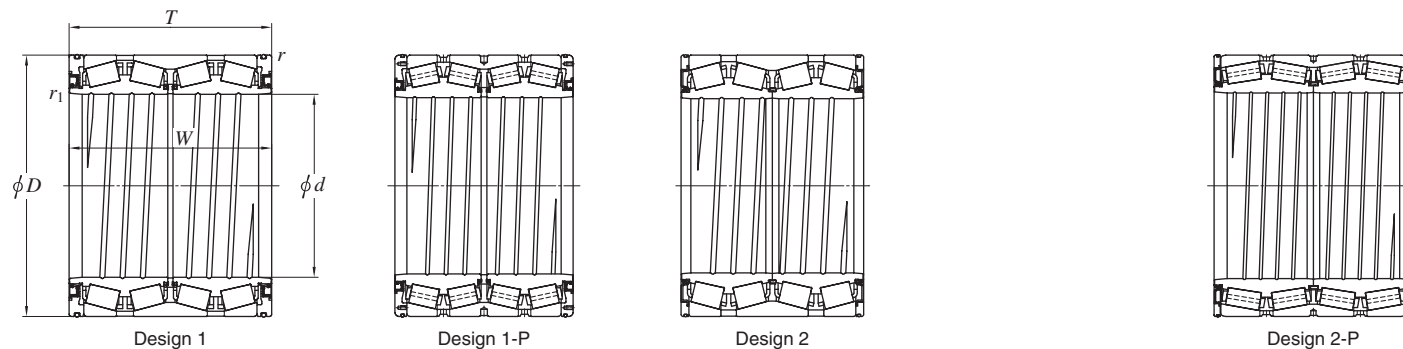

Boundary dimensions								Basic load ratings (kN)		Bearing No.	Design	Constant $e$	Axial load factors		(Refer.) Mass (kg)		
$d$ mm	$D$ mm	$T$ mm	$W$ mm	$r$ min.	$r_1$ <sup>1)</sup> min.	$C_r$	$C_{Or}$	$Y_2$	$Y_3$								
<b>280</b>	—	380	—	290	—	290	—	3.2	SP	2 720	6 940	2	0.33	2.03	3.02	93.8	
	—	395	—	290	—	290	—	3	2.5	2 640	5 940		1	0.4	1.68	2.5	110
	—	395	—	340	—	340	—	3	1.5	2 960	7 110		1	0.4	1.68	2.5	130
	—	410	—	268	—	268	—	5.4	1.6	2 240	4 510		1	0.33	2.03	3.02	118
	—	412	—	340	—	340	—	4	2	3 350	7 220		1	0.28	2.43	3.61	154
	—	430	—	350	—	350	—	3.5	1.5	3 940	8 190		1	0.4	1.68	2.5	178
<b>285</b>	—	400	—	340	—	340	—	3	1.5	3 190	7 610	1	0.4	1.68	2.5	131	
<b>285.750</b>	11.2500	380.898	14.9960	244.475	9.6250	244.475	9.6250	3.2	1	2 000	4 600	1	0.43	1.57	2.34	73.2	
<b>290</b>	—	400	—	346	—	346	—	4	1.5	3 070	7 860	1	0.4	1.68	2.5	128	
	—	400	—	420	—	420	—	4	1.5	3 070	7 860	1	0.4	1.68	2.5	155	
	—	420	—	380	—	380	—	3	1.2	3 640	8 260	1	0.4	1.68	2.5	175	
	—	450	—	415	—	415	—	4	1.5	4 460	9 460	1	0.47	1.43	2.12	238	
<b>300</b>	—	400	—	254	—	254	—	4	5	2 220	5 300	1	0.28	2.43	3.61	84.6	
	—	420	—	310	—	310	—	4	3.5	2 890	6 670	1	0.4	1.68	2.5	128	
<b>304.648</b>	11.9940	438.048	17.2460	279.400	11.0000	280.990	11.0626	4	1.6	2 570	5 380	1	0.47	1.44	2.15	135	
	11.9940	438.048	17.2460	279.400	11.0000	279.400	11.0000	3.2	1.6	3 140	6 860	2	0.4	1.68	2.5	135	
<b>304.800</b>	12.0000	419.100	16.5000	269.875	10.6250	269.875	10.6250	6.4	2	2 490	5 420	1	0.33	2.03	3.02	100	
	12.0000	501.650	19.7500	336.550	13.2500	296.550	11.6752	4	4	4 280	8 570	1-P	0.33	2.03	3.02	257	
<b>304.902</b>	12.0040	412.648	16.2460	266.700	10.5000	266.700	10.5000	3.2	0.8	2 750	6 820	2	0.39	1.74	2.59	99.5	
<b>310</b>	—	430	—	310	—	310	—	3	1	3 010	6 880	1	0.4	1.68	2.5	131	
	—	430	—	350	—	350	—	3.5	1.5	3 280	7 870	1	0.4	1.68	2.5	148	
	—	430	—	350	—	350	—	3.5	SP	3 280	7 870	1	0.4	1.68	2.5	148	
	—	457.098	—	390	—	390	—	4	1.5	4 200	9 500	1	0.32	2.12	3.15	220	
<b>317.500</b>	12.5000	447.675	17.6250	367.000	14.4488	367.000	14.4488	4	1.6	3 680	8 500	1	0.4	1.68	2.5	176	

[Note] 1) SP indicates the specially chamfered from.

# Sealed type four-row tapered roller bearings

$d$  320 ~ 406.400 mm

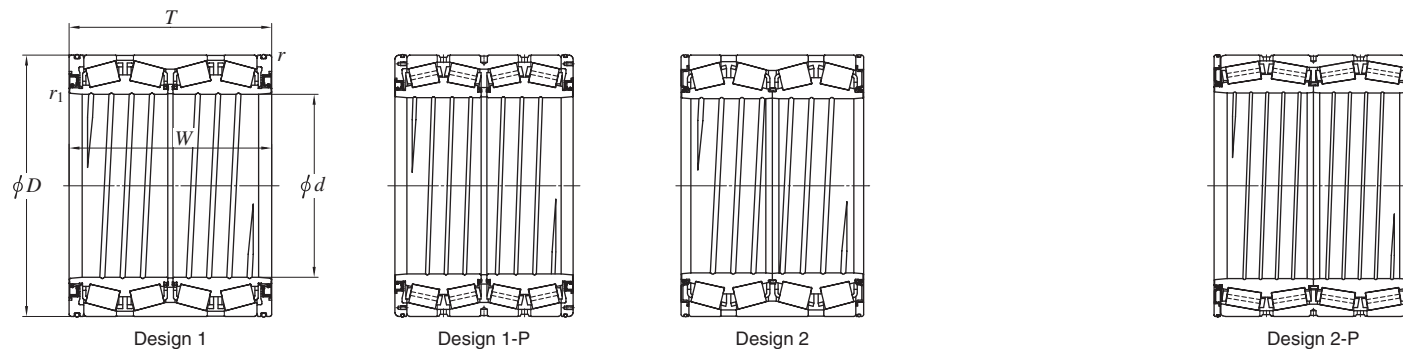

Boundary dimensions								Basic load ratings (kN)		Bearing No.	Design	Constant $e$	Axial load factors		(Refer.) Mass (kg)	
$d$ mm	$D$ mm	$T$ mm	$W$ mm	$r^{1)}$ min.	$r_1^{1)}$ min.	$C_r$	$C_{0r}$	$Y_2$	$Y_3$							
320	—	440	—	335	—	335	—	4	1	3 140	7 330	1	0.4	1.68	2.5	146
	—	480	—	360	—	360	—	4	1.5	4 210	8 800	1-P	0.47	1.43	2.12	220
	—	480	—	420	—	420	—	4	1.5	5 470	12 100	1-P	0.26	2.55	3.8	262
330.302	13.0040	438.023	17.2450	254.000	10.0000	247.650	9.7500	3.2	1.6	2 190	4 960	1	0.46	1.47	2.19	95.8
335.000	13.1890	460.000	18.1102	342.900	13.5000	342.900	13.5000	3.3	1.5	3 740	9 290	1	0.4	1.68	2.5	167
342.875	13.4990	488.900	19.2480	410.000	16.1417	410.000	16.1417	4	2	4 620	11 600	1	0.33	2.02	3	233
342.875	—	560	—	500	—	500	—	5	2.5	7 210	15 000	1-P	0.33	2.03	3.02	495
343.052	13.5060	457.098	17.9960	254.000	10.0000	254.000	10.0000	3.2	0.8	2 870	7 030	2	0.4	1.68	2.5	110
	13.5060	457.098	17.9960	299.000	11.7717	299.000	11.7717	3.2	SP	3 310	9 010	2	0.4	1.68	2.5	135
346.075	13.6250	488.950	19.2500	358.775	14.1250	358.775	14.1250	4	2	3 780	8 310	1	0.33	2.03	3.02	210
350	—	480	—	420	—	420	—	SP	1.5	3 700	9 100	1-P	0.4	1.68	2.5	217
355	—	490	—	316	—	316	—	2	1.6	3 540	7 920	1	0.33	2.03	3.02	169
355.600	14.0000	482.600	19.0000	269.875	10.6250	265.112	10.4375	3.2	1.5	2 680	6 090	1-P	0.47	1.43	2.12	134
360	—	480	—	375	—	375	—	3	1	4 120	10 600	1	0.4	1.68	2.5	181
374.650	14.7500	501.650	19.7500	260.350	10.2500	250.825	9.8750	3.2	1.6	3 120	7 470	2	0.33	2.03	3.02	136
380	—	580	—	370	—	370	—	3	SP	5 690	12 300	1-P	0.33	2.03	3.02	353
395	—	545	—	360	—	360	—	6	1.6	3 790	8 930	1	0.47	1.43	2.12	242
406.400	16.0000	546.100	21.5000	288.925	11.3750	288.925	11.3750	6.4	1	3 620	8 190	2-P	0.47	1.43	2.12	195
	16.0000	546.100	21.5000	330.000	12.9921	330.000	12.9921	4	1.5	4 310	10 500	2-P	0.43	1.57	2.34	204
	16.0000	546.100	21.5000	357.400	14.0709	357.400	14.0709	3.2	1.6	3 960	9 540	1	0.47	1.43	2.12	220

[Note] 1) SP indicates the specially chamfered from.

# Sealed type four-row tapered roller bearings

$d$  410 ~ (482.600) mm

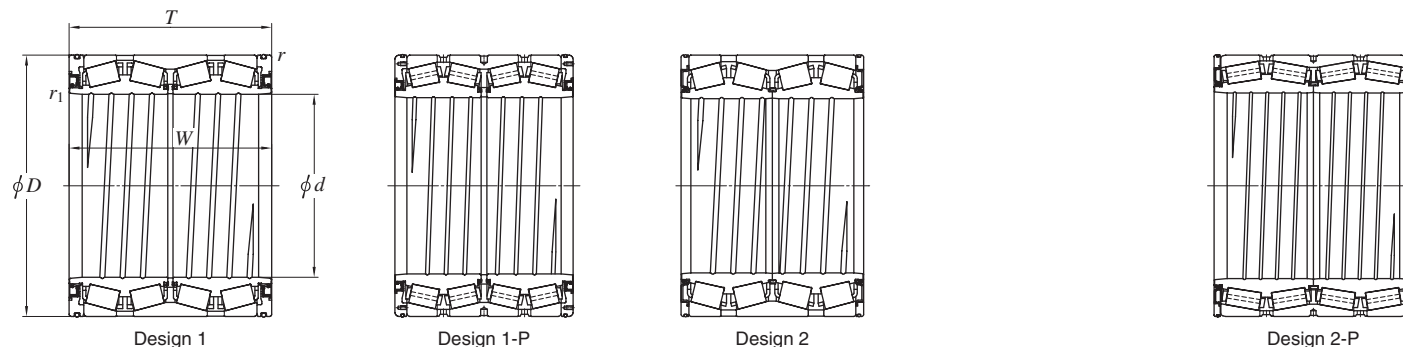

Boundary dimensions								Basic load ratings (kN)		Bearing No.	Design	Constant $e$	Axial load factors		(Refer.) Mass (kg)
$d$ mm	$D$ mm	$T$ mm	$W$ mm	$r_1^{1)}$ min.	$r_1^{1)}$ min.	$C_r$	$C_{Or}$	$Y_2$	$Y_3$						
410	546	400	400	4	1.5	4 630	12 000	47TS825540	1	0.26	2.55	3.8	255		
415.925	590.550	434.975	434.975	4	1.5	6 390	15 600	47TS835944A	2-P	0.4	1.68	2.5	377		
420	560	437	437	4	3	5 620	14 900	47TS845644	1	0.26	2.55	3.8	298		
	574	480	480	3	1.6	6 730	17 800	47TS845748	1-P	0.28	2.43	3.61	352		
	620	395	320	SP	SP	5 160	11 600	47TS846240	1-P	0.47	1.43	2.12	390		
430	575	380	380	3.2	SP	5 200	14 300	47TS865838A	2-P	0.26	2.55	3.8	276		
431.800	571.500	336.550	336.550	3.2	1.5	4 440	11 600	47TS865734A	2	0.4	1.68	2.5	229		
440	590	480	480	4	SP	6 870	18 700	47TS885948A-3	2-P	0.26	2.55	3.8	362		
	620	454	454	4	1.5	6 580	16 100	47TS886245-1	1-P	0.33	2.03	3.02	430		
	635	470	413	5	2	6 870	15 700	47TS886447	1	0.33	2.03	3.02	461		
450	595	420	420	5	1.5	6 110	16 300	47TS906042	1-P	0.26	2.55	3.8	308		
457.200	596.900	279.400	276.225	3.2	1.6	3 760	9 520	47TS916028C	2-P	0.47	1.43	2.12	191		
	596.900	279.400	276.225	3.2	1.6	3 300	8 180	47TS916028D	2-P	0.7	0.97	1.44	187		
460	620	470	470	4	1.5	7 060	19 300	47TS926247	1-P	0.26	2.55	3.8	412		
479.425	679.450	495.300	495.300	6.4	2	8 030	19 600	47TS966850	1-P	0.33	2.03	3.02	562		
480.000	647.700	417.512	417.512	6.4	SP	6 680	17 400	47TS966542	1-P	0.33	2.03	3.02	391		
480	700	470	470	5	1.5	8 080	18 800	47TS967047	1-P	0.32	2.12	3.15	621		
482.600	615.950	330.200	330.200	6.4	1.6	4 310	11 700	4TRS19B	1-P	0.44	1.54	2.3	240		
	615.950	330.200	330.200	3.2	1.6	4 360	11 800	4TRS19C	2	0.4	1.68	2.5	229		
	615.950	330.200	330.200	3.2	1.6	4 510	12 400	4TRS19D	2-P	0.4	1.68	2.5	239		
	615.950	385.000	385.000	6.4	1.6	5 270	15 000	47TS976239	1-P	0.33	2.03	3.02	278		
	615.950	420.000	420.000	6.4	1.6	5 090	14 500	47TS976242	1	0.33	2.03	3.02	302		

[Note] 1) SP indicates the specially chamfered from.

# Sealed type four-row tapered roller bearings

$d$  (482.600) ~ (711.200) mm

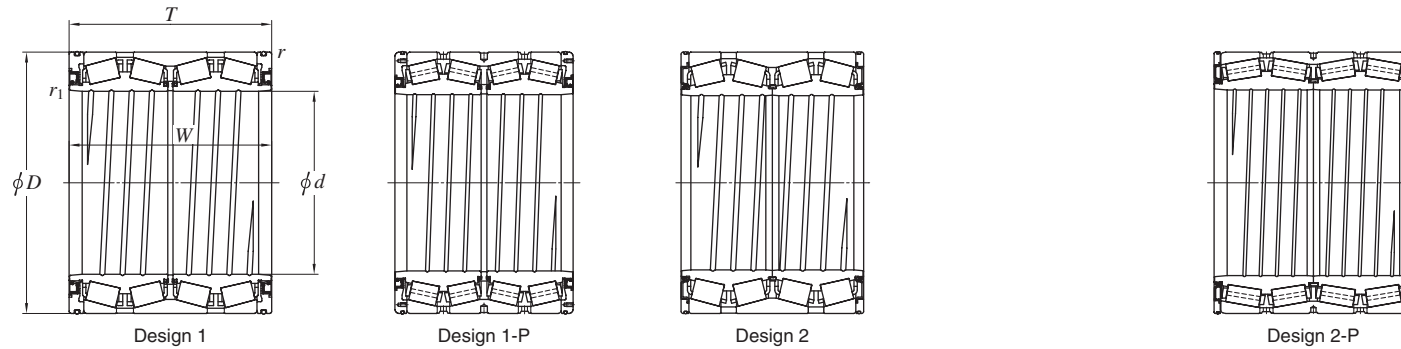

Boundary dimensions								Basic load ratings (kN)		Bearing No.	Design	Constant $e$	Axial load factors		(Refer.) Mass (kg)	
$d$ mm	$D$ mm	$T$ mm	$W$ mm	$r$ min.	$r_1$ <sup>1)</sup> min.	$C_r$	$C_{0r}$	$Y_2$	$Y_3$							
<b>482.600</b>	19.0000	615.950	24.2500	425.000	16.7323	425.000	16.7323	6.4	1.6	5 090	14 500	1	0.33	2.03	3.02	306
	19.0000	647.700	25.5000	417.512	16.4375	417.512	16.4375	6.4	1.6	6 680	17 400					
<b>488.950</b>	19.2500	622.300	24.5000	365.125	14.3750	365.125	14.3750	6.4	1.5	4 320	12 200	1	0.4	1.68	2.5	270
<b>492</b>	—	655	—	480	—	480	—	5	1.5	7 450	21 200	1-P	0.33	2.03	3.02	449
<b>509.948</b>	20.0767	654.924	25.7844	379.000	14.9213	377.000	14.8425	6.4	1.5	5 370	15 200	1-P	0.41	1.64	2.44	320
<b>530</b>	—	715	—	590	—	590	—	5	1.5	10 300	28 900	1-P	0.26	2.55	3.8	664
<b>558.800</b>	22.0000	736.600	29.0000	372.263	14.6560	372.263	14.6560	7	SP	6 910	16 100	1-P	0.34	1.97	2.93	425
	22.0000	736.600	29.0000	409.575	16.1250	409.575	16.1250	6	1.5	6 850	18 600	1-P	0.35	1.95	2.9	475
	22.0000	736.600	29.0000	450.000	17.7165	450.000	17.7165	6	1.5	7 180	19 700	1-P	0.35	1.95	2.9	507
	22.0000	736.600	29.0000	480.000	18.8976	480.000	18.8976	6	1.5	7 960	22 700	1-P	0.4	1.68	2.5	547
	22.0000	736.600	29.0000	500.000	19.6850	500.000	19.6850	6	1.6	8 220	23 100	1-P	0.35	1.95	2.9	560
<b>585.788</b>	23.0625	771.525	30.3750	479.425	18.8750	479.425	18.8750	6.4	1.5	8 730	24 400	1-P	0.33	2.03	3.02	613
<b>595.312</b>	23.4375	844.550	33.2500	615.950	24.2500	615.950	24.2500	6.4	3.6	12 700	32 200	1-P	0.33	2.03	3.02	1 120
<b>600</b>	—	870	—	700	—	700	—	5	4	15 100	39 400	1-P	0.33	2.03	3.02	1 370
<b>609.600</b>	24.0000	787.400	31.0000	361.950	14.2500	361.950	14.2500	6.4	3.2	5 920	14 900	1-P	0.4	1.68	2.5	430
	24.0000	813.562	32.0300	540.000	21.2598	540.000	21.2598	6.4	1.5	10 200	28 500	1-P	0.33	2.03	3.02	775
<b>679.450</b>	26.7500	901.700	35.5000	552.450	21.7500	552.450	21.7500	6.4	3	11 100	30 600	1-P	0.33	2.03	3.02	951
<b>685.800</b>	27.0000	876.300	34.5000	355.600	14.0000	352.425	13.8750	6.4	3.2	6 130	16 300	1-P	0.42	1.62	2.42	520
<b>704.850</b>	27.7500	914.400	36.0000	552.450	21.7500	552.450	21.7500	6.4	3.2	11 300	33 400	1-P	0.33	2.03	3.02	940
<b>711.200</b>	28.0000	914.400	36.0000	317.500	12.5000	317.500	12.5000	3.2	SP	6 070	16 700	2-P	0.46	1.47	2.19	507
	28.0000	914.400	36.0000	387.350	15.2500	387.350	15.2500	6.4	3.2	7 160	19 400	1-P	0.38	1.78	2.65	615

[Note] 1) SP indicates the specially chamfered from.



# Sealed type four-row tapered roller bearings

$d$  (711.200) ~ 800 mm

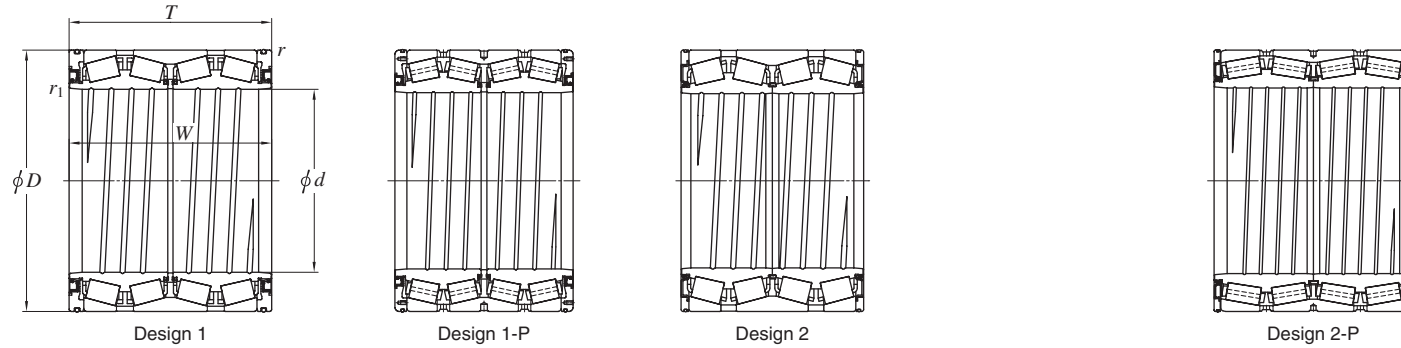

Boundary dimensions						Basic load ratings (kN)		Bearing No.	Design	Constant $e$	Axial load factors		(Refer.) Mass (kg)		
$d$ mm	$D$ mm	$T$ mm	$W$ mm	$r$ min.	$r_1$ min.	$C_r$	$C_{0r}$				$Y_2$	$Y_3$			
711.200	28.0000	914.400	36.0000	410.000	16.1417	410.000	16.1417	6.4	3.2	7 610	20 500	0.44	1.54	2.29	670
	28.0000	914.400	36.0000	420.000	16.5354	420.000	16.5354	6.4	3.2	7 870	22 200	0.4	1.68	2.5	678
800	—	1 130	—	780	—	780	—	6	1.5	21 900	58 800	0.26	2.55	3.8	2 520

# Spherical roller bearings

- Spherical roller bearings feature a large load rating capacity. This type of bearing is suitable for low- or medium-speed applications which involve heavy or impact loading.
- The spherical roller bearing is self-aligning, insensitive to misalignment of the shaft relative to the housing, and to shaft bending.
- Bearing with tapered bore can be easily mounted/dismounted by using an adapter assembly or withdrawal sleeve.
  - 1) 240 and 241 series ..... 1 : 30 (supplementary code K30)
  - 2) Others ..... 1 : 12 (supplementary code K)

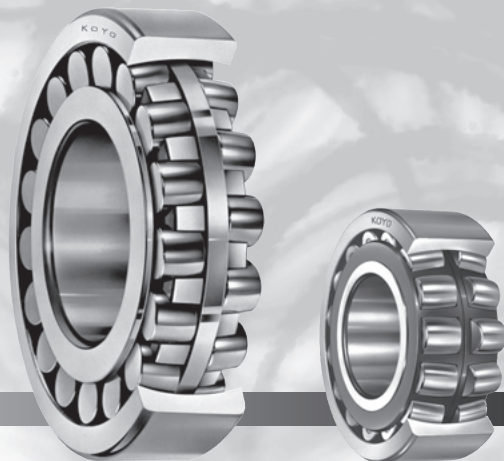

■ Cylindrical bore

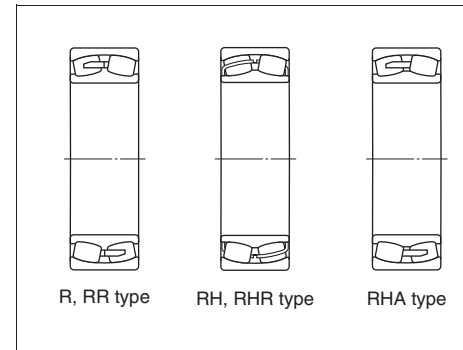

■ Tapered bore

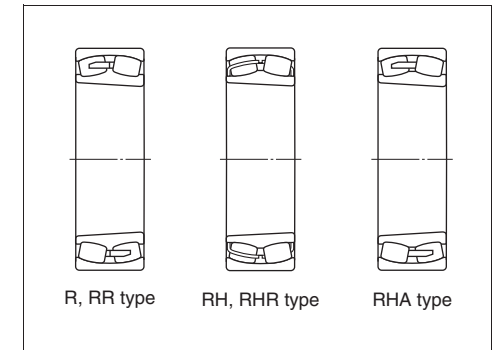

	R, RR type	RH, RHR type	RHA type
<b>Roller</b>	Convex asymmetrical roller	Convex symmetrical roller	Convex symmetrical roller
<b>Cage</b>	Copper alloy prong type machined cage	Pressed steel cage	Copper alloy integral type machined cage
<b>Inner ring (with or without rib)</b>	With center rib	Without center rib (floating guide ring)	Without center rib (floating guide ring)
	With ribs on both sides (to prevent rollers from falling)	Without ribs on both sides	With ribs on both sides (to prevent rollers from falling)
<b>Characteristics</b>	Superior to RH, RHR and RHA types in high-speed performance.	The load rating capacity is larger than that of R and RR type. (There are some exceptional cases due to different interior specifications.)	

- Outer rings can be provided with lubrication holes, a lubrication groove and an anti-rotation pin hole.

Supplementary code		Number of lubrication holes	Hole layout
With lubrication holes and lubrication groove	With lubrication holes, lubrication groove and anti-rotation pin hole		
<b>W33</b>	<b>W3N</b>	3 <sup>1)</sup>	3 equally spaced positions <sup>1)</sup>
W33A	W3NA	4	4 equally spaced positions
-	W3NB	5	6 equally spaced positions <sup>2)</sup>
W33C	W3NC	6	6 equally spaced positions
-	W3ND	7	8 equally spaced positions <sup>2)</sup>
W33T	-	8	8 equally spaced positions

- Inner rings can also be provided with lubrication holes and a lubrication groove.

Supplementary code	Inner ring		Outer ring	
	Number of lubrication holes	Lubrication groove	Number of lubrication holes	Lubrication groove
W513	3	-	3	○
W518	3	-	3	-
W26	3	-	-	-

[Notes] 1) Also 4 or 6 holes are provided.  
 2) One hole is used for the antirotation pin.  
 [Remark] Boldfaced codes indicate JTEKT standards.

■ Lubrication hole and lubrication groove dimensions  
(W33, W33A, W33C, W33T)

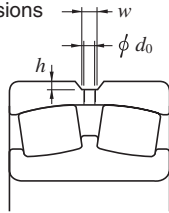

Unit : mm

Bore diameter number	Nominal bore diameter d	23900			23000			24000			23100			24100			22200			23200			21300			22300		
		d <sub>0</sub>	w	h	d <sub>0</sub>	w	h	d <sub>0</sub>	w	h	d <sub>0</sub>	w	h	d <sub>0</sub>	w	h	d <sub>0</sub>	w	h	d <sub>0</sub>	w	h	d <sub>0</sub>	w	h	d <sub>0</sub>	w	h
20	100	-	-	-	4	5	1	-	-	-	5	6	1.4	-	-	-	5	6	1.2	5	8	1.2	4	6	1.2	6	8	2
22	110	-	-	-	5	7	1	-	-	-	5	6	1.4	6	8	1.5	5	7	1.5	6	8	1.7	4	6	1.2	6	8	2
24	120	-	-	-	5	7	1	5	6	1.4	5	6	1.4	6	8	1.5	5	7	1.5	6	10	1.7	-	-	-	8	10	2.5
26	130	-	-	-	5	7	1.2	6	8	1.5	5	6	1.5	6	8	1.5	5	7	1.5	6	10	1.7	-	-	-	8	12	2.5
28	140	4	5	1	5	7	1.2	6	8	1.5	6	8	1.5	8	10	2	6	8	1.8	8	10	2.5	-	-	-	12	14	3
30	150	5	7	1	5	8	1.2	6	8	1.5	6	10	1.5	8	10	2	6	10	1.8	8	10	2.5	-	-	-	12	14	3
32	160	5	7	1.2	5	8	1.2	6	8	1.5	8	12	2	10	12	2	10	12	2.5	10	12	2.5	-	-	-	12	14	3
34	170	5	7	1.2	6	10	1.5	8	10	2	8	12	2	10	12	2	12	14	3	10	12	2.5	-	-	-	12	14	3
36	180	6	7	1.3	8	12	1.5	10	12	2.5	10	12	2.5	10	12	2	12	14	3	10	12	2.5	-	-	-	14	16.5	4
38	190	5	7	1.2	10	12	2.5	10	12	2.5	10	12	2.5	10	12	2	12	14	3	12	14	3	-	-	-	14	16.5	4
40	200	6	8	1.5	10	12	2.5	10	12	2.5	12	14	3	12	14	3	12	14	3	12	14	3	-	-	-	14	16.5	4
44	220	6	8	1.5	10	12	2.5	10	12	2.5	12	14	3	12	14	3	12	14	3	12	14	3	-	-	-	14	16.5	4
48	240	6	8	1.5	10	12	2.5	10	12	2.5	12	14	3	12	14	3	14	16.5	4	14	16.5	4	-	-	-	14	16.5	4
52	260	10	12	2.5	12	14	3	12	14	3	12	14	3	12	14	3	14	16.5	4	14	16.5	4	-	-	-	14	16.5	4
56	280	10	12	2.5	12	14	3	12	14	3	12	14	3	12	14	3	14	16.5	4	14	16.5	4	-	-	-	14	16.5	4
60	300	10	12	2.5	12	14	3	12	14	3	12	14	3	12	14	3	14	16.5	4	14	16.5	4	-	-	-	14	16.5	4
64	320	10	12	2.5	12	14	3	12	14	3	14	16.5	4	14	16.5	4	14	16.5	4	14	16.5	4	-	-	-	14	16.5	4
68	340	12	14	3	14	16.5	4	14	16.5	3	14	16.5	4	14	16.5	4	14	16.5	4	14	16.5	4	-	-	-	14	16.5	4
72	360	12	14	3	14	16.5	4	14	16.5	3	14	16.5	4	14	16.5	4	14	16.5	4	14	16.5	4	-	-	-	14	16.5	4
76	380	12	14	3	14	16.5	4	14	16.5	3	14	16.5	4	14	16.5	4	-	-	-	14	16.5	4	-	-	-	-	-	-
80	400	12	14	3	14	16.5	4	14	16.5	4	14	16.5	4	14	16.5	4	-	-	-	14	16.5	4	-	-	-	-	-	-
84	420	12	14	3	14	16.5	4	14	16.5	4	14	16.5	4	14	16.5	4	-	-	-	14	16.5	4	-	-	-	-	-	-
88	440	14	16.5	4	14	16.5	4	14	16.5	4	14	16.5	4	14	16.5	4	-	-	-	14	16.5	4	-	-	-	-	-	-
92	460	14	16.5	4	14	16.5	4	14	16.5	4	14	16.5	4	14	16.5	4	-	-	-	14	16.5	4	-	-	-	-	-	-
96	480	14	16.5	4	14	16.5	4	14	16.5	4	14	16.5	4	14	16.5	4	-	-	-	14	16.5	4	-	-	-	-	-	-
/500	500	14	16.5	4	14	16.5	4	14	16.5	4	14	16.5	4	14	16.5	5	-	-	-	14	16.5	4	-	-	-	-	-	-
/530	530	14	16.5	4	14	16.5	4	16	20	5	14	16.5	4	16	20	5	-	-	-	14	16.5	4	-	-	-	-	-	-
/560	560	14	16.5	4	14	16.5	4	16	20	5	14	16.5	4	16	20	5	-	-	-	14	16.5	4	-	-	-	-	-	-
/600	600	14	16.5	4	14	16.5	4	16	20	5	16	20	5	16	20	5	-	-	-	16	20	5	-	-	-	-	-	-
/630	630	14	16.5	4	14	16.5	4	16	20	5	16	20	5	16	20	5	-	-	-	16	20	5	-	-	-	-	-	-
/670	670	14	16.5	4	14	16.5	4	16	20	5	16	20	5	16	20	5	25	30	7	-	-	-	-	-	-	-	-	-
/710	710	14	16.5	4	14	16.5	4	16	20	5	16	20	5	25	30	7	-	-	-	-	-	-	-	-	-	-	-	-
/750	750	15	20	4	15	20	4	16	20	5	16	20	5	-	-	-	-	-	-	-	-	-	-	-	-	-	-	-
/800	800	15	20	4	15	20	4	16	20	5	16	20	5	-	-	-	-	-	-	-	-	-	-	-	-	-	-	-
/850	850	15	20	4	15	20	4	20	25	5	20	25	5	-	-	-	-	-	-	-	-	-	-	-	-	-	-	-
/900	900	16	20	5	15	20	5	20	25	5	20	25	5	-	-	-	-	-	-	-	-	-	-	-	-	-	-	-
/950	950	16	20	5	16	20	5	20	25	5	-	-	-	-	-	-	-	-	-	-	-	-	-	-	-	-	-	-
/1 000	1 000	16	20	5	16	20	5	20	25	5	-	-	-	-	-	-	-	-	-	-	-	-	-	-	-	-	-	-
/1 060	1 060	16	20	5	16	20	5	20	25	5	-	-	-	-	-	-	-	-	-	-	-	-	-	-	-	-	-	-
/1 120	1 120	16	20	5	-	-	-	20	25	5	-	-	-	-	-	-	-	-	-	-	-	-	-	-	-	-	-	-
/1 180	1 180	16	20	5	-	-	-	-	-	-	-	-	-	-	-	-	-	-	-	-	-	-	-	-	-	-	-	-
/1 250	1 250	16	20	5	-	-	-	-	-	-	-	-	-	-	-	-	-	-	-	-	-	-	-	-	-	-	-	-
/1 320	1 320	20	25	5	-	-	-	-	-	-	-	-	-	-	-	-	-	-	-	-	-	-	-	-	-	-	-	-
/1 400	1 400	20	25	5	-	-	-	-	-	-	-	-	-	-	-	-	-	-	-	-	-	-	-	-	-	-	-	-

<b>Boundary dimensions</b>	The dimensions of standard series are as specified in JIS B 1512.	
<b>Tolerances</b>	As specified in JIS B 1514, class 0. (refer to Table 2-2 on page 14.) Refer to Table 2-10 on page 30 for the tolerance of tapered bores.	
<b>Allowable aligning angle</b>	23800R ..... 0.017 rad (1°)	24100R, RH, RHA ..... 0.044 rad (2.5°)
	23900R ..... 0.026 rad (1.5°)	22200R, RR, RH, RHR, RHA ..... 0.026 rad (1.5°)
	23000R, RH, RHA ..... 0.026 rad (1.5°)	23200R, RH, RHA ..... 0.044 rad (2.5°)
	24000R, RH, RHA ..... 0.035 rad (2°)	21300R, RH ..... 0.017 rad (1°)
	23100R, RH, RHA ..... 0.026 rad (1.5°)	22300R, RR, RH, RHR, RHA ..... 0.035 rad (2°)
<b>Radial internal clearance</b>	(Refer to Table 4-6 on page 50.)	
<b>Equivalent radial load</b>	<b>Dynamic equivalent radial load</b> <span style="float: right;">[Note] Refer to the specification table for the values of axial load factors <math>Y_1</math>, <math>Y_2</math> and <math>Y_0</math> and of constant <math>e</math>.</span> $\left( \text{When } \frac{F_a}{F_r} \leq e \right) P_r = F_r + Y_1 F_a$ $\left( \text{When } \frac{F_a}{F_r} > e \right) P_r = 0.67 F_r + Y_2 F_a$ <b>Static equivalent radial load</b> $P_{0r} = F_r + Y_0 F_a$	

$d$  100 ~ (140) mm

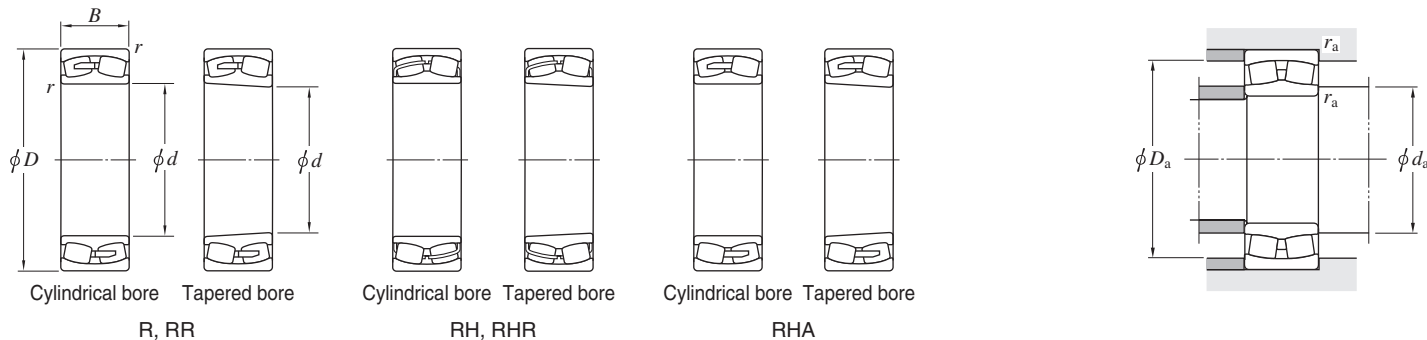

$d$	Boundary dimensions (mm)					Basic load ratings (kN)		Bearing No.		Mounting dimensions (mm)			Constant $e$	Axial load factors			(Refer.) Mass (kg)	
	$D$	$B$	$d_1$ (Refer.)	$D_1$ (Refer.)	$r$ min.	$C_r$	$C_{0r}$	Cylindrical bore	Tapered bore	$d_a$ min.	$D_a$ max.	$r_a$ max.		$Y_1$	$Y_2$	$Y_0$	Cylindrical bore	Tapered bore
100	150	37	112.2	135.6	1.5	208	332	23020RH	23020RHK	117	141	1.5	0.22	3.01	4.48	2.94	2.34	2.27
	180	46	117.2	160.7	2.1	377	481	22220RHR	22220RHRK	112	168	2	0.25	2.74	4.08	2.68	5.11	5.00
	180	60.3	118.5	153.7	2.1	425	629	23220RH	23220RHK	112	168	2	0.32	2.09	3.11	2.04	6.85	6.66
	215	47	132.5	181.5	3	416	524	21320RH	21320RHK	114	201	2.5	0.22	3.02	4.49	2.95	8.79	8.68
	215	73	123.8	184.6	3	700	877	22320RHR	22320RHRK	114	201	2.5	0.35	1.95	2.90	1.91	13.2	12.9
110	170	45	125	153	2	300	486	23022RH	23022RHK	120	160	2	0.24	2.84	4.23	2.78	3.85	3.74
	180	56	126.5	158	2	385	605	23122RH	23122RHK	120	170	2	0.29	2.36	3.51	2.31	5.72	5.54
	180	69	122.5	151.5	2	469	778	24122RH	24122RHK30	120	170	2	0.37	1.84	2.74	1.80	6.98	6.87
	200	53	129	178	2.1	491	642	22222RHR	22222RHRK	122	188	2	0.26	2.64	3.93	2.58	7.37	7.21
	200	69.8	129.5	170	2.1	537	792	23222RH	23222RHK	122	188	2	0.34	1.99	2.96	1.94	9.76	9.48
	240	50	148	202.5	3	484	616	21322RH	21322RHK	124	226	2.5	0.21	3.19	4.75	3.12	11.8	11.7
	240	80	138.5	206	3	828	1 040	22322RHR	22322RHRK	124	226	2.5	0.33	2.03	3.02	1.98	18.1	17.7
120	180	46	134.5	162	2	314	524	23024RH	23024RHK	130	170	2	0.23	2.95	4.40	2.89	4.20	4.07
	180	60	131.5	158	2	397	709	24024RH	24024RHK30	130	170	2	0.30	2.23	3.32	2.18	5.43	5.34
	200	62	139	174	2	454	714	23124RH	23124RHK	130	190	2	0.29	2.34	3.49	2.29	7.98	7.74
	200	80	135	169.5	2	605	1 020	24124RH	24124RHK30	130	190	2	0.38	1.75	2.61	1.72	10.2	10.0
	215	58	140	191	2.1	565	764	22224RHR	22224RHRK	132	203	2	0.26	2.60	3.87	2.54	9.31	9.10
	215	76	141	182	2.1	616	956	23224RH	23224RHK	132	203	2	0.34	1.97	2.94	1.93	12.2	11.8
	260	86	151.5	224	3	896	1 130	22324RHR	22324RHRK	134	246	2.5	0.33	2.03	3.02	1.98	22.8	22.3
130	200	52	146.5	179	2	404	674	23026RH	23026RHK	140	190	2	0.24	2.87	4.27	2.80	6.15	5.97
	200	69	144.5	174.5	2	512	914	24026RH	24026RHK30	140	190	2	0.32	2.14	3.18	2.09	8.03	7.90
	210	64	149	185	2	494	799	23126RH	23126RHK	140	200	2	0.28	2.42	3.61	2.37	8.71	8.44
	210	80	147.5	181.5	2	620	1 080	24126RH	24126RHK30	140	200	2	0.36	1.90	2.83	1.86	10.8	10.6
	230	64	150.5	204	3	658	914	22226RHR	22226RHRK	144	216	2.5	0.26	2.55	3.80	2.50	11.6	11.3
	230	80	153	197.5	3	702	1 090	23226RH	23226RHK	144	216	2.5	0.33	2.05	3.05	2.00	14.4	14.0
	280	93	163	241	4	1 040	1 340	22326RHR	22326RHRK	148	262	3	0.33	2.03	3.02	1.98	28.5	27.9
140	210	53	157	189	2	422	723	23028RH	23028RHK	150	200	2	0.23	2.98	4.44	2.92	6.62	6.42

[Remark] For bearings with lubrication holes and lubrication grooves on the outer ring, refer to page 367 and 368.

Spherical roller bearings

d (140) ~ (170) mm

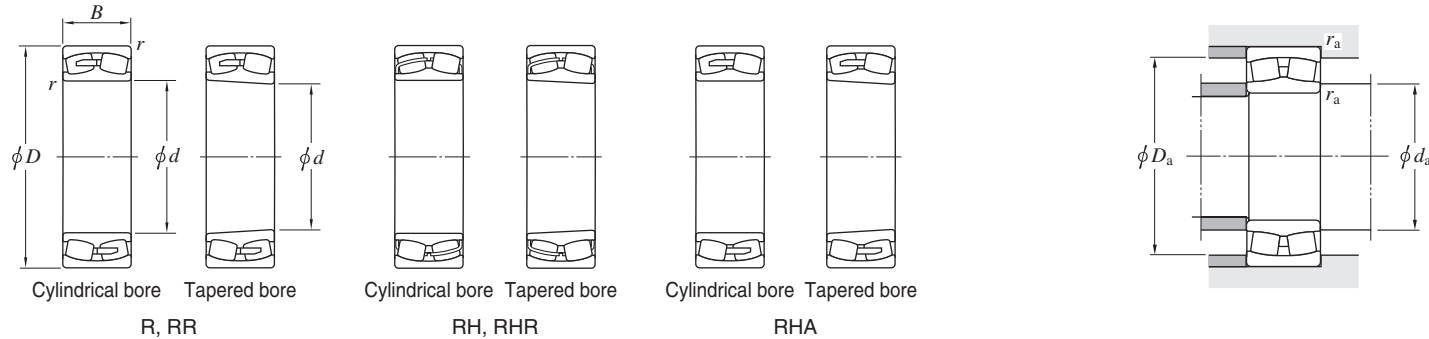

d	Boundary dimensions (mm)					Basic load ratings (kN)		Bearing No.		Mounting dimensions (mm)	Constant	Axial load factors			(Refer.) Mass (kg)			
	D	B	d <sub>1</sub> (Refer.)	D <sub>1</sub> (Refer.)	r min.	C <sub>r</sub>	C <sub>0r</sub>	Cylindrical bore	Tapered bore			d <sub>a</sub> min.	D <sub>a</sub> max.	r <sub>a</sub> max.	e	Y <sub>1</sub>	Y <sub>2</sub>	Y <sub>0</sub>
140	210	69	155	185.5	2	524	957	24028RH	24028RHK30	150	200	2	0.30	2.28	3.39	2.23	8.49	8.35
	225	68	160.5	198.5	2.1	565	940	23128RH	23128RHK	152	213	2	0.28	2.45	3.65	2.40	10.6	10.3
	225	85	155.5	192	2.1	702	1 220	24128RH	24128RHK30	152	213	2	0.36	1.89	2.82	1.85	13.1	12.9
	250	68	160.5	222	3	759	1 030	22228RHR	22228RHRK	154	236	2.5	0.26	2.60	3.87	2.54	14.5	14.2
	250	88	164	210.5	3	811	1 290	23228RH	23228RHK	154	236	2.5	0.34	1.99	2.96	1.95	19.0	18.4
	300	102	174	252	4	1 170	1 570	22328RH	22328RHK	158	282	3	0.35	1.95	2.90	1.90	35.7	34.9
150	210	45	171	193	2	334	622	23930R	23930RK	160	200	2	0.20	3.44	5.12	3.36	5.09	4.93
	225	56	168.5	203	2.1	461	797	23030RH	23030RHK	162	213	2	0.22	3.04	4.53	2.97	8.01	7.77
	225	75	166	198	2.1	593	1 100	24030RH	24030RHK30	162	213	2	0.30	2.23	3.32	2.18	10.6	10.4
	250	80	173	213.5	2.1	717	1 230	23130RH	23130RHK	162	238	2	0.30	2.24	3.34	2.19	16.4	15.9
	250	100	169	211	2.1	915	1 590	24130RH	24130RHK30	162	238	2	0.38	1.77	2.64	1.73	19.9	19.6
	270	73	175	240	3	865	1 200	22230RHR	22230RHRK	164	256	2.5	0.25	2.69	4.00	2.63	18.9	18.5
	270	96	176	226.5	3	959	1 540	23230RH	23230RHK	164	256	2.5	0.34	1.96	2.93	1.92	24.5	23.8
	320	108	198	269.5	4	1 230	1 600	22330R	22330RK	168	302	3	0.38	1.78	2.64	1.74	43.6	42.7
320	108	200.5	269.5	4	1 290	1 740	22330RHA	22330RHAK	168	302	3	0.35	1.93	2.87	1.88	40.3	39.4	
160	220	45	180	202	2	341	649	23932R	23932RK	170	210	2	0.19	3.60	5.37	3.52	5.37	5.20
	240	60	179.5	216.5	2.1	531	924	23032RH	23032RHK	172	228	2	0.22	3.01	4.48	2.94	9.74	9.44
	240	80	177	212.5	2.1	679	1 270	24032RH	24032RHK30	172	228	2	0.30	2.24	3.34	2.19	12.9	12.7
	270	86	184	230.5	2.1	848	1 430	23132RH	23132RHK	172	258	2	0.30	2.22	3.30	2.17	20.8	20.2
	270	109	191	228	2.1	1 010	1 720	24132RR	24132RRK30	172	258	2	0.39	1.72	2.56	1.68	25.9	25.5
	290	80	201	254.5	3	885	1 270	22232R	22232RK	174	276	2.5	0.28	2.40	3.57	2.35	23.4	22.9
	290	80	203	254	3	897	1 320	22232RHA	22232RHAK	174	276	2.5	0.27	2.49	3.71	2.44	21.9	21.4
	290	104	197.5	242	3	1 030	1 650	23232R	23232RK	174	276	2.5	0.38	1.79	2.66	1.75	31.0	30.1
	290	104	196.5	242	3	1 100	1 780	23232RHA	23232RHAK	174	276	2.5	0.36	1.87	2.78	1.83	29.4	28.5
	340	114	210	286.5	4	1 380	1 790	22332R	22332RK	178	322	3	0.38	1.76	2.62	1.72	51.9	51.0
340	114	214.5	286.5	4	1 420	1 940	22332RHA	22332RHAK	178	322	3	0.35	1.94	2.89	1.90	48.0	47.1	
170	230	45	190	212.5	2	353	691	23934R	23934RK	180	220	2	0.18	3.78	5.63	3.70	5.67	5.49
	260	67	191.5	233	2.1	632	1 090	23034RH	23034RHK	182	248	2	0.23	2.90	4.31	2.83	13.2	12.8

[Remark] For bearings with lubrication holes and lubrication grooves on the outer ring, refer to page 367 and 368.

Spherical roller bearings

d (170) ~ (190) mm

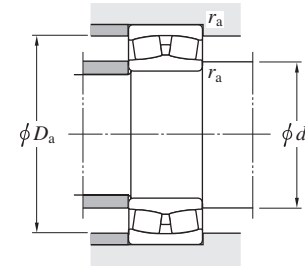
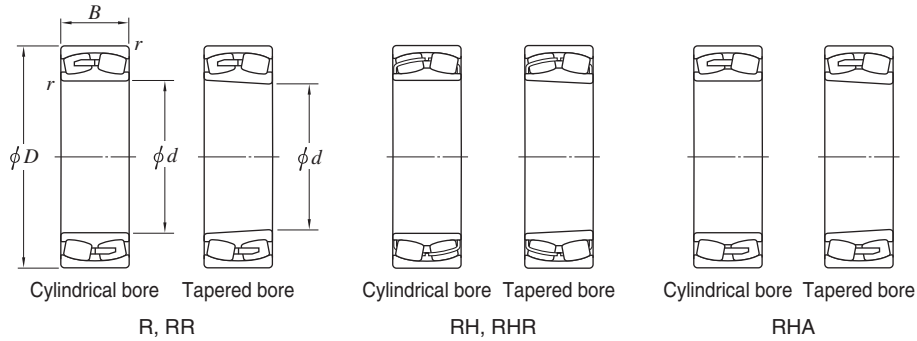

d	Boundary dimensions (mm)					Basic load ratings (kN)		Bearing No.		Mounting dimensions (mm)			Constant e	Axial load factors			(Refer.) Mass (kg)	
	D	B	d <sub>1</sub> (Refer.)	D <sub>1</sub> (Refer.)	r min.	C <sub>r</sub>	C <sub>0r</sub>	Cylindrical bore	Tapered bore	d <sub>a</sub> min.	D <sub>a</sub> max.	r <sub>a</sub> max.		Y <sub>1</sub>	Y <sub>2</sub>	Y <sub>0</sub>	Cylindrical bore	Tapered bore
170	260	90	187	225	2.1	828	1 540	24034RH	24034RHK30	182	248	2	0.32	2.11	3.15	2.07	17.5	17.2
	280	88	196	245.5	2.1	916	1 550	23134RH	23134RHK	182	268	2	0.29	2.30	3.43	2.25	21.9	21.2
	280	109	201.5	239	2.1	1 050	1 820	24134RR	24134RRK30	182	268	2	0.37	1.80	2.68	1.76	27.2	26.8
	310	86	214	268	4	952	1 390	22234R	22234RK	188	292	3	0.29	2.29	3.41	2.24	29.0	28.4
	310	86	214	268	4	1 010	1 490	22234RHA	22234RHAK	188	292	3	0.28	2.45	3.64	2.39	27.1	26.5
	310	110	213.5	260	4	1 150	1 870	23234R	23234RK	188	292	3	0.37	1.81	2.70	1.77	37.5	36.5
	310	110	210	259	4	1 210	1 940	23234RHA	23234RHAK	188	292	3	0.36	1.89	2.82	1.85	35.6	34.6
	360	120	224	303.5	4	1 460	1 920	22334R	22334RK	188	342	3	0.38	1.77	2.64	1.73	62.0	60.8
	360	120	226.5	303.5	4	1 590	2 200	22334RHA	22334RHAK	188	342	3	0.35	1.95	2.91	1.91	57.3	56.1
	180	250	52	204.5	230.5	2	479	939	23936R	23936RK	190	240	2	0.19	3.55	5.29	3.48	8.22
280		74	205	251	2.1	768	1 330	23036RH	23036RHK	192	268	2	0.24	2.84	4.23	2.78	17.4	16.9
280		100	209.5	244	2.1	933	1 710	24036RR	24036RRK30	192	268	2	0.34	2.00	2.98	1.96	23.4	23.0
300		96	216.5	255.5	3	1 000	1 800	23136R	23136RK	194	286	2.5	0.33	2.04	3.04	2.00	28.4	27.5
300		96	217	261.5	3	1 060	1 790	23136RHA	23136RHAK	194	286	2.5	0.31	2.19	3.25	2.14	26.5	25.6
300		118	214	255	3	1 220	2 120	24136RR	24136RRK30	194	286	2.5	0.38	1.78	2.65	1.74	34.4	33.9
300		118	212	252	3	1 250	2 240	24136RHA	24136RHAK30	194	286	2.5	0.38	1.79	2.66	1.75	31.8	31.2
320		86	224	278.5	4	978	1 450	22236R	22236RK	198	302	3	0.28	2.37	3.53	2.32	30.5	29.8
320		86	224	278.5	4	1 060	1 610	22236RHA	22236RHAK	198	302	3	0.26	2.55	3.80	2.50	28.5	27.8
320		112	221.5	269.5	4	1 190	1 980	23236R	23236RK	198	302	3	0.37	1.84	2.74	1.80	39.8	38.6
320		112	222.5	274	4	1 320	2 170	23236RHA	23236RHAK	198	302	3	0.34	1.97	2.93	1.92	37.7	36.5
380		126	242	324	4	1 740	2 360	22336R	22336RK	198	362	3	0.36	1.89	2.81	1.84	71.4	69.9
380		126	240	321	4	1 740	2 410	22336RHA	22336RHAK	198	362	3	0.34	1.97	2.94	1.93	66.0	64.5
190		260	52	213.5	239.5	2	486	969	23938R	23938RK	200	250	2	0.18	3.69	5.50	3.61	8.40
	290	75	223	257	2.1	736	1 370	23038R	23038RK	202	278	2	0.25	2.67	3.97	2.61	18.8	18.2
	290	75	220	256.5	2.1	789	1 430	23038RHA	23038RHAK	202	278	2	0.25	2.75	4.10	2.69	17.2	16.6
	290	100	218.5	254.5	2.1	989	1 840	24038RR	24038RRK30	202	278	2	0.33	2.06	3.07	2.02	24.5	24.1
	290	100	218	254	2.1	1 010	1 920	24038RHA	24038RHAK30	202	278	2	0.32	2.14	3.19	2.09	22.4	22.0
	320	104	231.5	272	3	1 090	2 000	23138R	23138RK	204	306	2.5	0.34	1.96	2.92	1.92	35.5	34.4
	320	104	230.5	278	3	1 210	2 080	23138RHA	23138RHAK	204	306	2.5	0.31	2.14	3.19	2.10	33.2	32.1

[Remark] For bearings with lubrication holes and lubrication grooves on the outer ring, refer to page 367 and 368.

d (190) ~ (220) mm

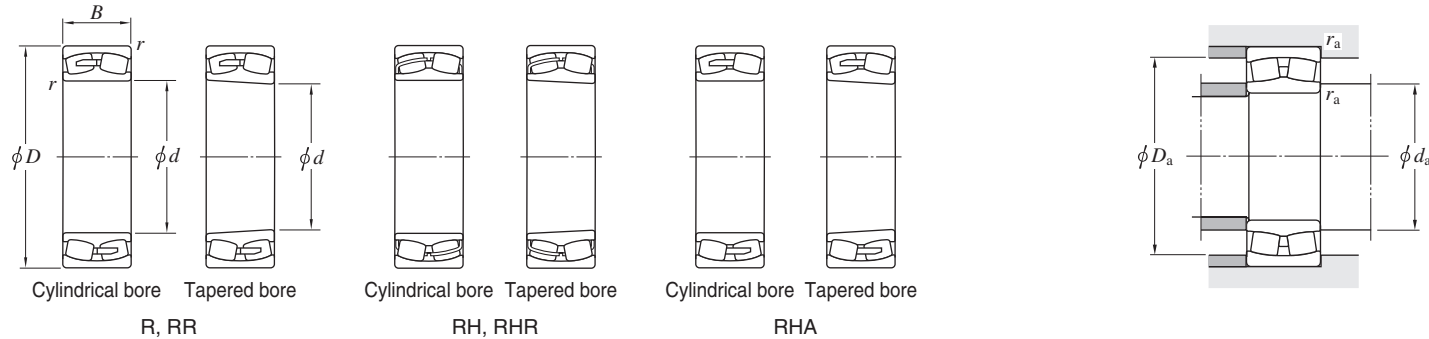

d	Boundary dimensions (mm)					Basic load ratings (kN)		Bearing No.		Mounting dimensions (mm)			Constant e	Axial load factors			(Refer.) Mass (kg)	
	D	B	d <sub>1</sub> (Refer.)	D <sub>1</sub> (Refer.)	r min.	C <sub>r</sub>	C <sub>0r</sub>	Cylindrical bore	Tapered bore	d <sub>a</sub> min.	D <sub>a</sub> max.	r <sub>a</sub> max.		Y <sub>1</sub>	Y <sub>2</sub>	Y <sub>0</sub>	Cylindrical bore	Tapered bore
190	320	128	227	270.5	3	1 400	2 470	24138RR	24138RRK30	204	306	2.5	0.39	1.74	2.59	1.70	43.0	42.4
	320	128	226	270	3	1 460	2 630	24138RHA	24138RHAK30	204	306	2.5	0.38	1.76	2.63	1.72	40.1	39.5
	340	92	238	293.5	4	1 110	1 730	22238R	22238RK	208	322	3	0.29	2.29	3.41	2.24	37.4	36.6
	340	92	237.5	293.5	4	1 150	1 770	22238RHA	22238RHAK	208	322	3	0.27	2.52	3.76	2.46	34.9	34.1
	340	120	236	285.5	4	1 410	2 210	23238R	23238RK	208	322	3	0.36	1.87	2.79	1.83	47.4	46.0
	340	120	236	290	4	1 490	2 470	23238RHA	23238RHAK	208	322	3	0.35	1.94	2.89	1.90	44.9	43.5
	400	132	252	337.5	5	1 900	2 610	22338R	22338RK	212	378	4	0.38	1.79	2.66	1.75	84.1	82.4
	200	280	60	228	257.5	2.1	601	1 190	23940R	23940RK	212	268	2	0.20	3.44	5.13	3.37	12.0
310		82	237.5	274.5	2.1	890	1 670	23040R	23040RK	212	298	2	0.26	2.62	3.90	2.56	24.1	23.4
310		82	233	274.5	2.1	940	1 680	23040RHA	23040RHAK	212	298	2	0.25	2.68	3.99	2.62	22.0	21.3
310		109	231.5	270.5	2.1	1 140	2 110	24040RR	24040RRK30	212	298	2	0.33	2.02	3.00	1.97	31.2	30.7
310		109	230	268.5	2.1	1 180	2 230	24040RHA	24040RHAK30	212	298	2	0.33	2.06	3.07	2.02	28.5	28.0
340		112	245	288	3	1 240	2 250	23140R	23140RK	214	326	2.5	0.34	1.97	2.94	1.93	43.7	42.4
340		112	242	294.5	3	1 380	2 340	23140RHA	23140RHAK	214	326	2.5	0.32	2.10	3.13	2.06	40.8	39.5
340		140	238.5	286	3	1 620	2 820	24140RR	24140RRK30	214	326	2.5	0.40	1.68	2.49	1.64	53.3	52.5
340		140	236	284	3	1 660	2 970	24140RHA	24140RHAK30	214	326	2.5	0.41	1.65	2.46	1.62	49.5	48.7
360		98	251.5	311	4	1 230	1 930	22240R	22240RK	218	342	3	0.30	2.26	3.36	2.21	45.0	44.0
360		98	250	311	4	1 310	2 030	22240RHA	22240RHAK	218	342	3	0.27	2.50	3.72	2.45	42.0	41.0
360		128	248	301.5	4	1 550	2 610	23240R	23240RK	218	342	3	0.38	1.79	2.67	1.75	58.1	56.4
360		128	249.5	306.5	4	1 660	2 780	23240RHA	23240RHAK	218	342	3	0.35	1.92	2.86	1.88	55.1	53.4
420		138	264	354.5	5	2 010	2 750	22340R	22340RK	222	398	4	0.38	1.80	2.68	1.76	95.4	93.5
220	300	60	247	277	2.1	634	1 300	23944R	23944RK	232	288	2	0.18	3.70	5.50	3.61	13.0	12.6
	340	90	258	298	3	984	1 890	23044R	23044RK	234	326	2.5	0.26	2.55	3.80	2.50	31.5	30.6
	340	90	257	304	3	1 090	1 950	23044RHA	23044RHAK	234	326	2.5	0.25	2.69	4.01	2.63	28.8	27.9
	340	118	255	297	3	1 320	2 480	24044RR	24044RRK30	234	326	2.5	0.33	2.04	3.04	2.00	40.5	39.8
	340	118	251	295	3	1 380	2 630	24044RHA	24044RHAK30	234	326	2.5	0.33	2.08	3.09	2.03	37.0	36.4
	370	120	269	315	4	1 440	2 700	23144R	23144RK	238	352	3	0.34	2.00	2.98	1.96	54.8	53.2
	370	120	266	321	4	1 590	2 790	23144RHA	23144RHAK	238	352	3	0.31	2.15	3.20	2.10	51.2	49.6
	370	150	262	313	4	1 880	3 390	24144RR	24144RRK30	238	352	3	0.39	1.71	2.55	1.67	67.3	66.2

[Remark] For bearings with lubrication holes and lubrication grooves on the outer ring, refer to page 367 and 368.

Spherical roller bearings

d (220) ~ (260) mm

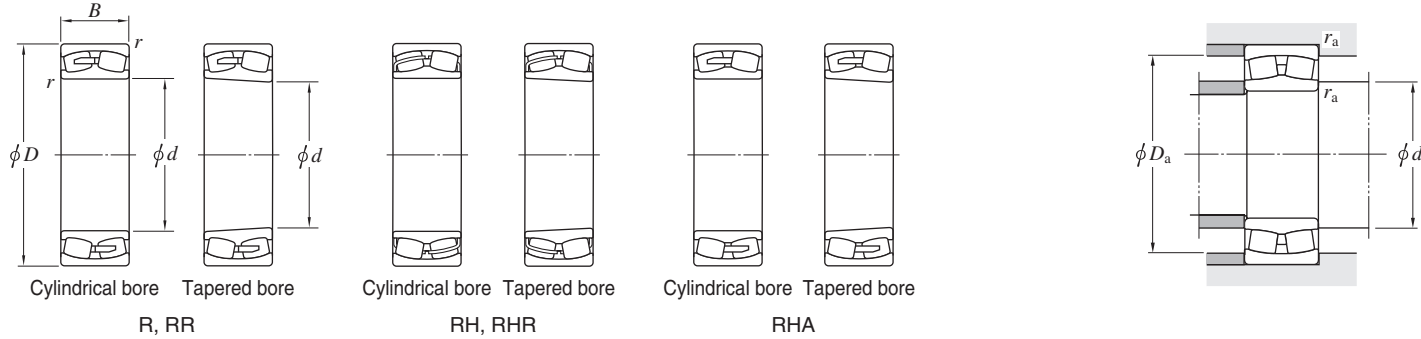

Boundary dimensions (mm)						Basic load ratings (kN)		Bearing No.		Mounting dimensions (mm)			Constant	Axial load factors			(Refer.) Mass (kg)	
d	D	B	d <sub>1</sub> (Refer.)	D <sub>1</sub> (Refer.)	r min.	C <sub>r</sub>	C <sub>0r</sub>	Cylindrical bore	Tapered bore	d <sub>a</sub> min.	D <sub>a</sub> max.	r <sub>a</sub> max.	e	Y <sub>1</sub>	Y <sub>2</sub>	Y <sub>0</sub>	Cylindrical bore	Tapered bore
220	370	150	260	311	4	1 920	3 550	24144RHA	24144RHAK30	238	352	3	0.40	1.69	2.52	1.65	62.0	61.0
	400	108	279	348	4	1 560	2 400	22244R	22244RK	238	382	3	0.28	2.40	3.57	2.34	63.0	61.7
	400	144	272	332	4	1 880	3 200	23244R	23244RK	238	382	3	0.39	1.71	2.55	1.68	81.6	79.2
	400	144	276	342	4	2 020	3 350	23244RHA	23244RHAK	238	382	3	0.36	1.89	2.81	1.85	77.4	75.0
	460	145	296	391	5	2 380	3 380	22344R	22344RK	242	438	4	0.34	2.00	2.99	1.96	124	122
	460	145	295	387	5	2 370	3 470	22344RHA	22344RHAK	242	438	4	0.32	2.08	3.09	2.03	115	113
240	320	60	266	296	2.1	651	1 380	23948R	23948RK	252	308	2	0.17	3.95	5.88	3.86	14.0	13.5
	360	92	279	320	3	1 100	2 170	23048R	23048RK	254	346	2.5	0.25	2.71	4.04	2.65	34.9	33.8
	360	92	278	324	3	1 170	2 180	23048RHA	23048RHAK	254	346	2.5	0.24	2.83	4.21	2.77	31.9	30.9
	360	118	275	319	3	1 390	2 710	24048RR	24048RRK30	254	346	2.5	0.31	2.20	3.27	2.15	43.5	42.9
	360	118	272	317	3	1 430	2 840	24048RHA	24048RHAK30	254	346	2.5	0.30	2.24	3.33	2.19	39.6	39.0
	400	128	293	342	4	1 630	3 080	23148R	23148RK	258	382	3	0.33	2.05	3.05	2.00	67.6	65.6
	400	128	290	349	4	1 810	3 200	23148RHA	23148RHAK	258	382	3	0.31	2.19	3.25	2.14	63.1	61.1
	400	160	285	339	4	2 100	3 850	24148RR	24148RRK30	258	382	3	0.39	1.75	2.60	1.71	82.7	81.4
	400	160	283	338	4	2 200	4 130	24148RHA	24148RHAK30	258	382	3	0.39	1.72	2.56	1.68	76.6	75.3
	440	120	303	381	4	1 920	2 940	22248R	22248RK	258	422	3	0.29	2.35	3.50	2.30	85.0	83.2
	440	160	301	369	4	2 340	3 990	23248R	23248RK	258	422	3	0.39	1.73	2.57	1.69	110	107
	440	160	301	373	4	2 460	4 130	23248RHA	23248RHAK	258	422	3	0.36	1.87	2.78	1.83	104	101
	500	155	324	415	5	2 610	4 020	22348R	22348RK	262	478	4	0.35	1.94	2.89	1.90	157	154
	260	360	75	294	331	2.1	914	1 880	23952R	23952RK	272	348	2	0.19	3.54	5.27	3.46	24.0
400		104	304	358	4	1 330	2 570	23052R	23052RK	278	382	3	0.25	2.65	3.95	2.59	50.7	49.3
400		104	306	354	4	1 470	2 720	23052RHA	23052RHAK	278	382	3	0.25	2.75	4.10	2.69	46.3	44.9
400		140	300	349	4	1 810	3 570	24052RR	24052RRK30	278	382	3	0.33	2.02	3.01	1.98	66.3	65.2
400		140	296	345	4	1 860	3 670	24052RHA	24052RHAK30	278	382	3	0.33	2.06	3.07	2.02	60.3	59.4
440		144	318	373	4	2 100	3 860	23152R	23152RK	278	422	3	0.33	2.03	3.02	1.98	93.6	90.8
440		144	316	381	4	2 220	4 000	23152RHA	23152RHAK	278	422	3	0.32	2.12	3.16	2.08	87.4	84.6
440		180	309	371	4	2 590	4 700	24152RR	24152RRK30	278	422	3	0.40	1.69	2.51	1.65	114	112
440		180	305	366	4	2 650	4 950	24152RHA	24152RHAK30	278	422	3	0.41	1.66	2.47	1.62	106	105
480		130	331	417	5	2 240	3 460	22252R	22252RK	282	458	4	0.28	2.40	3.57	2.35	110	108

[Remark] For bearings with lubrication holes and lubrication grooves on the outer ring, refer to page 367 and 368.



# Spherical roller bearings

$d$  (260) ~ (300) mm

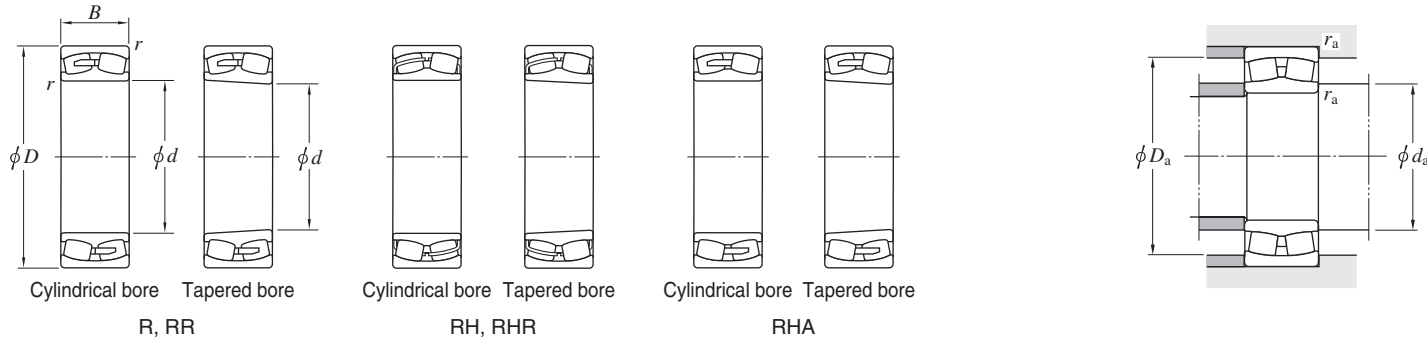

Boundary dimensions (mm)						Basic load ratings (kN)		Bearing No.		Mounting dimensions (mm)			Constant $e$	Axial load factors			(Refer.) Mass (kg)		
$d$	$D$	$B$	$d_1$ (Refer.)	$D_1$ (Refer.)	$r$ min.	$C_r$	$C_{0r}$	Cylindrical bore	Tapered bore	$d_a$ min.	$D_a$ max.	$r_a$ max.		$Y_1$	$Y_2$	$Y_0$	Cylindrical bore	Tapered bore	
260	480	130	329	416	5	2 230	3 430	22252RHA	22252RHAK	282	458	4	0.27	2.50	3.72	2.44	103	101	
	480	174	329	405	5	2 750	4 640	23252R	23252RK	282	458	4	0.40	1.69	2.51	1.65	144	140	
	480	174	327	405	5	2 870	4 900	23252RHA	23252RHAK	282	458	4	0.36	1.87	2.78	1.83	137	133	
	540	165	350	448	6	2 830	4 380	22352R	22352RK	288	512	5	0.35	1.94	2.89	1.90	196	192	
	540	165	348	457	6	3 120	4 620	22352RHA	22352RHAK	288	512	5	0.31	2.15	3.21	2.11	181	177	
	280	380	75	314	351	2.1	928	1 960	23956R	23956RK	292	368	2	0.18	3.74	5.57	3.66	26.0	25.2
420		106	325	372	4	1 430	2 860	23056R	23056RK	298	402	3	0.25	2.74	4.08	2.68	54.5	52.9	
420		106	324	378	4	1 550	2 950	23056RHA	23056RHAK	298	402	3	0.24	2.87	4.27	2.80	49.8	48.2	
420		140	320	371	4	1 890	3 780	24056RR	24056RRK30	298	402	3	0.31	2.15	3.21	2.11	70.2	69.1	
420		140	318	369	4	1 960	4 000	24056RHA	24056RHAK30	298	402	3	0.31	2.20	3.28	2.15	64.0	62.9	
460		146	337	392	5	2 140	4 280	23156R	23156RK	302	438	4	0.33	2.04	3.03	1.99	100	96.9	
460		146	336	402	5	2 340	4 290	23156RHA	23156RHAK	302	438	4	0.30	2.22	3.30	2.17	93.4	90.3	
460		180	332	393	5	2 700	5 140	24156RR	24156RRK30	302	438	4	0.38	1.79	2.67	1.75	122	120	
460		180	326	388	5	2 740	5 240	24156RHA	24156RHAK30	302	438	4	0.38	1.76	2.62	1.72	113	112	
500		130	350	433	5	2 100	3 380	22256R	22256RK	302	478	4	0.28	2.42	3.60	2.37	114	112	
500		130	350	438	5	2 320	3 670	22256RHA	22256RHAK	302	478	4	0.26	2.64	3.93	2.58	106	104	
500		176	349	416	5	2 690	4 910	23256R	23256RK	302	478	4	0.37	1.83	2.72	1.79	153	149	
500		176	348	427	5	3 010	5 300	23256RHA	23256RHAK	302	478	4	0.35	1.95	2.91	1.91	145	141	
580		175	376	480	6	3 150	4 910	22356R	22356RK	308	552	5	0.34	1.98	2.95	1.93	229	225	
300		420	90	339	385	3	1 280	2 610	23960R	23960RK	314	406	2.5	0.20	3.42	5.09	3.34	40.0	38.8
		460	118	353	408	4	1 750	3 480	23060R	23060RK	318	442	3	0.25	2.69	4.00	2.63	75.8	73.7
	460	118	350	412	4	1 940	3 700	23060RHA	23060RHAK	318	442	3	0.24	2.79	4.16	2.73	68.9	66.8	
	460	160	346	403	4	2 350	4 690	24060RR	24060RRK30	318	442	3	0.33	2.04	3.04	2.00	99.5	97.9	
	460	160	344	401	4	2 420	4 910	24060RHA	24060RHAK30	318	442	3	0.32	2.09	3.11	2.04	90.7	89.1	
	500	160	363	427	5	2 490	4 850	23160R	23160RK	322	478	4	0.33	2.02	3.01	1.98	132	128	
	500	160	361	436	5	2 730	4 970	23160RHA	23160RHAK	322	478	4	0.31	2.18	3.25	2.13	123	119	
	500	200	353	422	5	3 320	6 280	24160RR	24160RRK30	322	478	4	0.40	1.67	2.49	1.63	162	160	
	500	200	353	422	5	3 320	6 420	24160RHA	24160RHAK30	322	478	4	0.39	1.72	2.56	1.68	150	148	
	540	140	373	465	5	2 690	4 330	22260R	22260RK	322	518	4	0.27	2.48	3.69	2.43	145	142	

[Remark] For bearings with lubrication holes and lubrication grooves on the outer ring, refer to page 367 and 368.

# Spherical roller bearings

d (300) ~ (360) mm

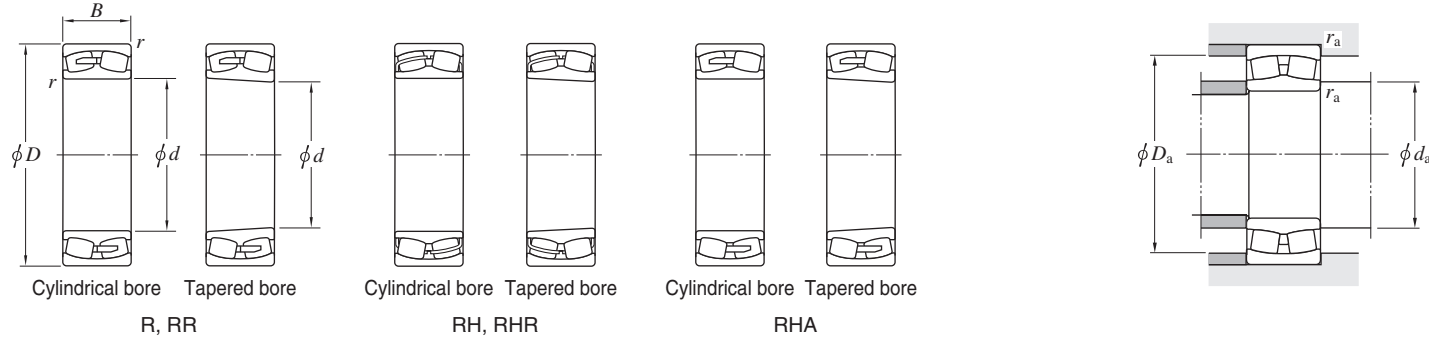

d	Boundary dimensions (mm)					Basic load ratings (kN)		Bearing No.		Mounting dimensions (mm)			Constant	Axial load factors			(Refer.) Mass (kg)	
	D	B	d <sub>1</sub> (Refer.)	D <sub>1</sub> (Refer.)	r min.	C <sub>r</sub>	C <sub>0r</sub>	Cylindrical bore	Tapered bore	d <sub>a</sub> min.	D <sub>a</sub> max.	r <sub>a</sub> max.	e	Y <sub>1</sub>	Y <sub>2</sub>	Y <sub>0</sub>	Cylindrical bore	Tapered bore
300	540	192	375	462	5	3 430	5 910	<b>23260R</b>	<b>23260RK</b>	322	518	4	0.37	1.83	2.72	1.79	197	192
	540	192	376	462	5	3 540	6 310	<b>23260RHA</b>	<b>23260RHAK</b>	322	518	4	0.35	1.93	2.88	1.89	187	182
	620	185	398	541	7.5	3 910	5 430	<b>22360R</b>	<b>22360RK</b>	336	584	6	0.32	2.09	3.10	2.04	289	284
320	440	90	361	406	3	1 330	2 870	<b>23964R</b>	<b>23964RK</b>	334	426	2.5	0.19	3.61	5.38	3.53	43.0	41.7
	480	121	372	426	4	1 830	3 740	<b>23064R</b>	<b>23064RK</b>	338	462	3	0.24	2.76	4.11	2.70	81.2	78.8
	480	121	370	432	4	1 980	3 850	<b>23064RHA</b>	<b>23064RHAK</b>	338	462	3	0.24	2.87	4.27	2.80	74.5	72.1
	480	160	367	424	4	2 400	4 920	<b>24064RR</b>	<b>24064RRK30</b>	338	462	3	0.31	2.16	3.22	2.11	105	103
	480	160	365	422	4	2 510	5 230	<b>24064RHA</b>	<b>24064RHAK30</b>	338	462	3	0.31	2.21	3.29	2.16	93.4	91.4
	540	176	393	461	5	2 900	5 700	<b>23164R</b>	<b>23164RK</b>	342	518	4	0.33	2.04	3.04	2.00	171	166
	540	176	387	468	5	3 220	5 960	<b>23164RHA</b>	<b>23164RHAK</b>	342	518	4	0.32	2.13	3.17	2.08	160	155
	540	218	380	457	5	3 730	6 950	<b>24164RR</b>	<b>24164RRK30</b>	342	518	4	0.39	1.72	2.56	1.68	208	205
	540	218	378	453	5	3 760	7 190	<b>24164RHA</b>	<b>24164RHAK30</b>	342	518	4	0.40	1.70	2.52	1.66	199	196
	580	150	405	499	5	2 730	4 540	<b>22264R</b>	<b>22264RK</b>	342	558	4	0.28	2.41	3.59	2.35	175	171
	580	208	398	482	5	3 630	6 550	<b>23264R</b>	<b>23264RK</b>	342	558	4	0.38	1.76	2.62	1.72	249	242
	580	208	399	493	5	4 010	7 030	<b>23264RHA</b>	<b>23264RHAK</b>	342	558	4	0.36	1.90	2.83	1.86	236	229
340	460	90	380	424	3	1 350	2 980	<b>23968R</b>	<b>23968RK</b>	354	446	2.5	0.18	3.82	5.69	3.74	45.0	43.6
	520	133	400	460	5	2 130	4 330	<b>23068R</b>	<b>23068RK</b>	362	498	4	0.25	2.69	4.00	2.63	108	105
	520	133	397	466	5	2 330	4 470	<b>23068RHA</b>	<b>23068RHAK</b>	362	498	4	0.24	2.80	4.18	2.74	98.7	95.7
	520	180	393	457	5	2 920	5 970	<b>24068RR</b>	<b>24068RRK30</b>	362	498	4	0.33	2.06	3.06	2.01	142	140
	520	180	390	456	5	3 040	6 330	<b>24068RHA</b>	<b>24068RHAK30</b>	362	498	4	0.32	2.11	3.14	2.06	130	128
	580	190	417	491	5	3 280	6 430	<b>23168R</b>	<b>23168RK</b>	362	558	4	0.34	1.97	2.93	1.93	216	210
	580	190	413	501	5	3 680	6 720	<b>23168RHA</b>	<b>23168RHAK</b>	362	558	4	0.32	2.11	3.14	2.06	202	196
	580	243	405	487	5	4 440	8 400	<b>24168RR</b>	<b>24168RRK30</b>	362	558	4	0.41	1.64	2.45	1.61	270	266
	580	243	397	479	5	4 540	8 810	<b>24168RHA</b>	<b>24168RHAK30</b>	362	558	4	0.42	1.61	2.39	1.57	259	255
	620	165	427	547	6	3 550	5 430	<b>22268R</b>	<b>22268RK</b>	368	592	5	0.28	2.43	3.61	2.37	221	216
	620	224	428	514	6	4 090	7 560	<b>23268R</b>	<b>23268RK</b>	368	592	5	0.38	1.77	2.63	1.73	306	297
	620	224	425	527	6	4 550	8 030	<b>23268RHA</b>	<b>23268RHAK</b>	368	592	5	0.36	1.88	2.81	1.84	290	281
360	480	90	400	445	3	1 360	3 060	<b>23972R</b>	<b>23972RK</b>	374	466	2.5	0.17	3.95	5.88	3.86	46.5	45.0
	540	134	419	480	5	2 280	4 800	<b>23072R</b>	<b>23072RK</b>	382	518	4	0.24	2.76	4.11	2.70	115	111

[Remark] For bearings with lubrication holes and lubrication grooves on the outer ring, refer to page 367 and 368.

*d* (360) ~ (420) mm

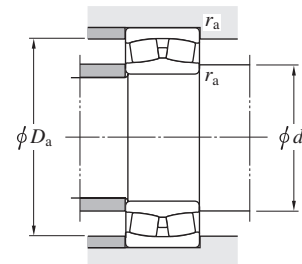
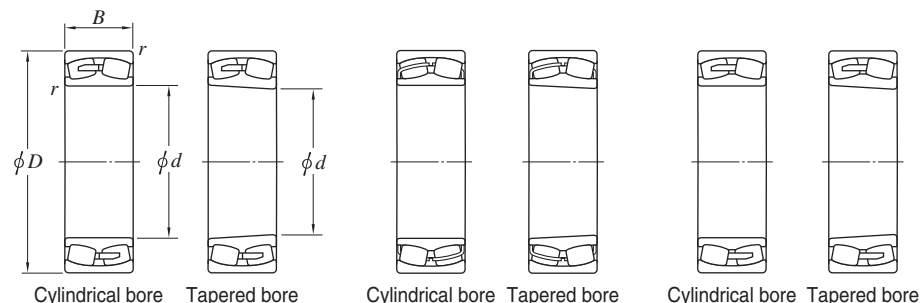

Boundary dimensions (mm)						Basic load ratings (kN)		Bearing No.		Mounting dimensions (mm)			Constant	Axial load factors			(Refer.) Mass (kg)	
<i>d</i>	<i>D</i>	<i>B</i>	<i>d</i> <sub>1</sub> (Refer.)	<i>D</i> <sub>1</sub> (Refer.)	<i>r</i> min.	<i>C</i> <sub>r</sub>	<i>C</i> <sub>0r</sub>	Cylindrical bore	Tapered bore	<i>d</i> <sub>a</sub> min.	<i>D</i> <sub>a</sub> max.	<i>r</i> <sub>a</sub> max.	<i>e</i>	<i>Y</i> <sub>1</sub>	<i>Y</i> <sub>2</sub>	<i>Y</i> <sub>0</sub>	Cylindrical bore	Tapered bore
360	540	134	417	486	5	2 420	4 770	23072RHA	23072RHAK	382	518	4	0.23	2.92	4.34	2.85	105	101
	540	180	413	478	5	3 030	6 300	24072RR	24072RRK30	382	518	4	0.31	2.15	3.21	2.11	149	147
	540	180	411	477	5	3 120	6 620	24072RHA	24072RHAK30	382	518	4	0.30	2.22	3.30	2.17	135	133
	600	192	435	523	5	3 770	7 040	23172R	23172RK	382	578	4	0.33	2.07	3.09	2.03	228	221
	600	243	426	507	5	4 080	7 690	24172R	24172RK30	382	578	4	0.39	1.74	2.59	1.70	287	283
	650	170	450	575	6	3 770	5 830	22272R	22272RK	388	622	5	0.27	2.47	3.68	2.42	248	243
	650	232	452	552	6	4 850	8 810	23272R	23272RK	388	622	5	0.37	1.83	2.72	1.79	346	336
	380	520	106	427	479	4	1 780	3 940	23976R	23976RK	398	502	3	0.19	3.62	5.39	3.54	70.0
560		135	436	498	5	2 320	4 970	23076R	23076RK	402	538	4	0.24	2.79	4.16	2.73	122	118
560		135	437	508	5	2 520	5 080	23076RHA	23076RHAK	402	538	4	0.22	3.03	4.51	2.96	112	108
560		180	434	499	5	3 110	6 590	24076RR	24076RRK30	402	538	4	0.30	2.26	3.36	2.21	156	154
560		180	432	498	5	3 190	6 910	24076RHA	24076RHAK30	402	538	4	0.29	2.32	3.45	2.27	142	139
620		194	458	533	5	3 590	7 320	23176R	23176RK	402	598	4	0.31	2.18	3.24	2.13	240	233
620		194	455	544	5	4 000	7 700	23176RHA	23176RHAK	402	598	4	0.30	2.26	3.36	2.21	224	217
620		243	444	525	5	4 220	8 220	24176R	24176RK30	402	598	4	0.38	1.78	2.65	1.74	302	297
620		243	446	530	5	4 830	9 840	24176RHA	24176RHAK30	402	598	4	0.38	1.78	2.65	1.74	288	283
680		240	476	580	6	5 200	9 500	23276R	23276RK	408	652	5	0.36	1.85	2.76	1.81	386	375
400		540	106	445	497	4	1 880	4 300	23980R	23980RK	418	522	3	0.18	3.76	5.59	3.67	73.0
	600	148	467	534	5	2 710	5 790	23080R	23080RK	422	578	4	0.24	2.84	4.23	2.78	155	151
	600	148	464	541	5	2 930	5 860	23080RHA	23080RHAK	422	578	4	0.23	2.94	4.37	2.87	142	138
	600	200	455	527	5	3 830	8 110	24080R	24080RK30	422	578	4	0.32	2.09	3.12	2.05	206	203
	600	200	456	530	5	3 780	8 140	24080RHA	24080RHAK30	422	578	4	0.31	2.21	3.29	2.16	192	189
	650	200	480	558	6	4 110	7 780	23180R	23180RK	428	622	5	0.31	2.19	3.25	2.14	273	265
	650	250	468	554	6	4 640	9 140	24180R	24180RK30	428	622	5	0.37	1.82	2.70	1.78	338	333
	650	250	469	555	6	5 180	10 600	24180RHA	24180RHAK30	428	622	5	0.37	1.82	2.71	1.78	322	317
	720	256	500	598	6	5 210	9 850	23280R	23280RK	428	692	5	0.37	1.80	2.69	1.76	468	454
	720	256	498	615	6	5 850	10 600	23280RHA	23280RHAK	428	692	5	0.35	1.92	2.86	1.88	441	427
	420	560	106	467	520	4	1 880	4 320	23984R	23984RK	438	542	3	0.17	3.91	5.82	3.82	76.0

[Remark] For bearings with lubrication holes and lubrication grooves on the outer ring, refer to page 367 and 368.

$d$  (420) ~ (480) mm

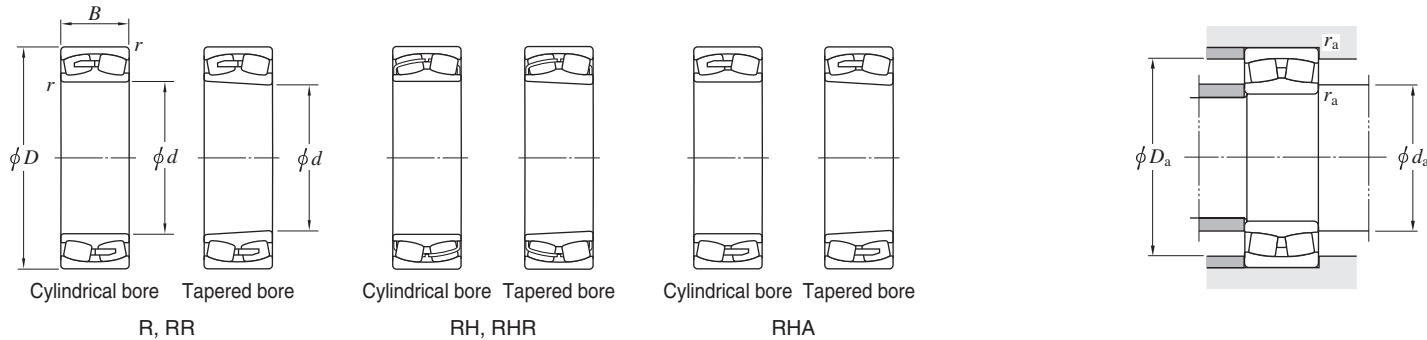

Boundary dimensions (mm)						Basic load ratings (kN)		Bearing No.		Mounting dimensions (mm)			Constant	Axial load factors			(Refer.) Mass (kg)	
$d$	$D$	$B$	$d_1$ (Refer.)	$D_1$ (Refer.)	$r$ min.	$C_r$	$C_{0r}$	Cylindrical bore	Tapered bore	$d_a$ min.	$D_a$ max.	$r_a$ max.	$e$	$Y_1$	$Y_2$	$Y_0$	Cylindrical bore	Tapered bore
420	620	150	487	554	5	2 800	6 120	<b>23084R</b>	<b>23084RK</b>	442	598	4	0.23	2.90	4.31	2.83	164	159
	620	200	477	550	5	3 590	7 600	<b>24084R</b>	<b>24084RK30</b>	442	598	4	0.30	2.23	3.32	2.18	212	209
	620	200	477	550	5	3 870	8 490	<b>24084RHA</b>	<b>24084RHAK30</b>	442	598	4	0.29	2.31	3.44	2.26	198	195
	700	224	510	598	6	4 470	9 110	<b>23184R</b>	<b>23184RK</b>	448	672	5	0.33	2.03	3.02	1.98	363	352
	700	224	507	611	6	5 040	9 630	<b>23184RHA</b>	<b>23184RHAK</b>	448	672	5	0.31	2.19	3.25	2.14	339	328
	700	280	494	589	6	5 450	10 600	<b>24184R</b>	<b>24184RK30</b>	448	672	5	0.40	1.71	2.54	1.67	445	438
	700	280	495	592	6	6 120	12 400	<b>24184RHA</b>	<b>24184RHAK30</b>	448	672	5	0.39	1.72	2.56	1.68	425	418
	760	272	521	646	7.5	6 500	11 500	<b>23284R</b>	<b>23284RK</b>	456	724	6	0.37	1.84	2.74	1.80	556	540
440	600	118	492	552	4	2 330	5 330	<b>23988R</b>	<b>23988RK</b>	458	582	3	0.18	3.75	5.58	3.66	101	97.8
	650	157	505	578	6	3 030	6 540	<b>23088R</b>	<b>23088RK</b>	468	622	5	0.24	2.76	4.11	2.70	188	183
	650	157	507	589	6	3 370	6 910	<b>23088RHA</b>	<b>23088RHAK</b>	468	622	5	0.22	3.04	4.53	2.97	172	167
	650	212	502	575	6	3 910	8 320	<b>24088R</b>	<b>24088RK30</b>	468	622	5	0.29	2.35	3.50	2.30	247	243
	720	226	530	618	6	5 040	9 600	<b>23188R</b>	<b>23188RK</b>	468	692	5	0.33	2.08	3.09	2.03	378	366
	720	226	527	631	6	5 250	10 300	<b>23188RHA</b>	<b>23188RHAK</b>	468	692	5	0.30	2.25	3.34	2.20	353	341
	720	280	515	611	6	5 640	11 200	<b>24188R</b>	<b>24188RK30</b>	468	692	5	0.38	1.76	2.62	1.72	460	453
	720	280	518	612	6	6 200	12 900	<b>24188RHA</b>	<b>24188RHAK30</b>	468	692	5	0.38	1.79	2.67	1.75	439	432
790	280	549	679	7.5	6 860	12 300	<b>23288R</b>	<b>23288RK</b>	476	754	6	0.36	1.86	2.77	1.82	613	595	
460	600	90	522	566	3	1 440	3 660	<b>23896R</b>	<b>23896RK</b>	476	586	2.5	0.13	5.06	7.53	4.95	60.4	58.4
	620	118	515	574	4	2 330	5 350	<b>23992R</b>	<b>23992RK</b>	478	602	3	0.17	3.89	5.79	3.80	107	104
	680	163	533	606	6	3 240	7 170	<b>23092R</b>	<b>23092RK</b>	488	652	5	0.23	2.92	4.34	2.85	215	209
	680	163	530	615	6	3 600	7 430	<b>23092RHA</b>	<b>23092RHAK</b>	488	652	5	0.22	3.04	4.53	2.97	197	191
	680	218	525	602	6	4 570	10 100	<b>24092R</b>	<b>24092RK30</b>	488	652	5	0.30	2.23	3.32	2.18	277	272
	760	240	515	574	7.5	5 180	10 800	<b>23192R</b>	<b>23192RK</b>	496	724	6	0.33	2.07	3.09	2.03	450	436
	760	300	546	641	7.5	6 040	12 200	<b>24192R</b>	<b>24192RK30</b>	496	724	6	0.35	1.95	2.90	1.91	550	541
	760	300	541	644	7.5	6 920	14 200	<b>24192RHA</b>	<b>24192RHAK30</b>	496	724	6	0.38	1.75	2.61	1.72	525	516
830	296	575	712	7.5	7 610	13 700	<b>23292R</b>	<b>23292RK</b>	496	794	6	0.36	1.85	2.76	1.81	720	699	
480	650	128	537	600	5	2 630	6 130	<b>23996R</b>	<b>23996RK</b>	502	628	4	0.18	3.75	5.59	3.67	123	119
	700	165	553	626	6	3 350	7 540	<b>23096R</b>	<b>23096RK</b>	508	672	5	0.22	3.01	4.47	2.94	225	218
	700	218	543	622	6	4 420	9 650	<b>24096R</b>	<b>24096RK30</b>	508	672	5	0.29	2.32	3.45	2.26	287	282

[Remark] For bearings with lubrication holes and lubrication grooves on the outer ring, refer to page 367 and 368.

d (480) ~ (600) mm

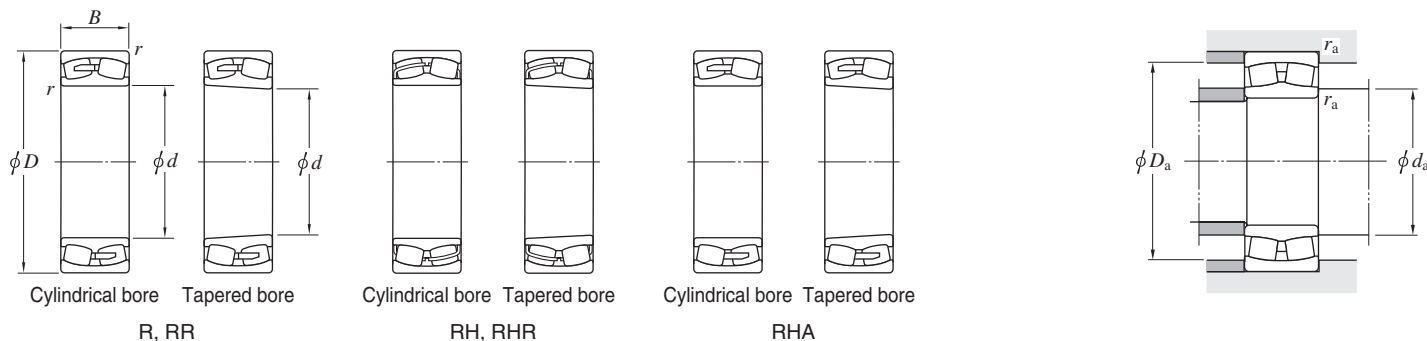

d	Boundary dimensions (mm)					Basic load ratings (kN)		Bearing No.		Mounting dimensions (mm)			Constant e	Axial load factors			(Refer.) Mass (kg)	
	D	B	d <sub>1</sub> (Refer.)	D <sub>1</sub> (Refer.)	r min.	C <sub>r</sub>	C <sub>0r</sub>	Cylindrical bore	Tapered bore	d <sub>a</sub> min.	D <sub>a</sub> max.	r <sub>a</sub> max.		Y <sub>1</sub>	Y <sub>2</sub>	Y <sub>0</sub>	Cylindrical bore	Tapered bore
480	700	218	544	622	6	4 750	10 700	24096RHA	24096RHAK30	508	672	5	0.28	2.41	3.59	2.35	268	263
	790	248	538	679	7.5	5 440	11 500	23196R	23196RK	516	754	6	0.32	2.09	3.12	2.05	503	488
	790	308	570	674	7.5	7 190	14 800	24196R	24196RK30	516	754	6	0.39	1.74	2.59	1.70	606	597
	870	310	596	740	7.5	8 380	15 100	23296R	23296RK	516	834	6	0.36	1.85	2.75	1.81	831	807
500	670	128	556	619	5	2 670	6 310	239/500R	239/500RK	522	648	4	0.17	3.87	5.76	3.79	131	127
	720	167	572	650	6	3 580	8 090	230/500R	230/500RK	528	692	5	0.23	2.94	4.37	2.87	235	228
	720	218	564	644	6	4 600	10 300	240/500R	240/500RK30	528	692	5	0.28	2.39	3.56	2.34	297	292
	830	264	607	709	7.5	6 160	13 000	231/500R	231/500RK	536	794	6	0.33	2.05	3.05	2.00	595	577
	830	325	598	707	7.5	7 710	15 900	241/500R	241/500RK30	536	794	6	0.36	1.85	2.76	1.81	712	701
	920	336	628	765	7.5	8 770	16 700	232/500R	232/500RK	536	884	6	0.39	1.74	2.59	1.70	1 020	992
530	710	136	589	657	5	2 980	7 120	239/530R	239/530RK	552	688	4	0.17	3.86	5.75	3.78	157	152
	780	185	609	696	6	4 090	9 050	230/530R	230/530RK	558	752	5	0.24	2.84	4.23	2.78	314	304
	780	185	610	707	6	4 090	9 050	230/530RHA	230/530RHAK	558	752	5	0.22	3.08	4.59	3.02	307	297
	780	250	604	691	6	5 430	12 100	240/530R	240/530RK30	558	752	5	0.30	2.26	3.36	2.21	414	408
	870	272	635	760	7.5	7 170	14 200	231/530R	231/530RK	566	834	6	0.32	2.14	3.18	2.09	661	641
	870	335	625	738	7.5	8 500	18 000	241/530R	241/530RK30	566	834	6	0.38	1.78	2.65	1.74	796	784
	980	355	666	832	9.5	10 500	18 900	232/530R	232/530RK	574	936	8	0.37	1.82	2.71	1.78	1 230	1 200
	560	680	90	601	647	3	1 640	4 470	238/560R	—	574	666	2	0.12	5.70	8.48	5.57	70.0
750		140	624	696	5	3 110	7 350	239/560R	239/560RK	582	728	4	0.17	3.96	5.90	3.87	182	176
750		140	623	696	5	3 120	7 470	239/560RHA	239/560RHAK	582	728	4	0.16	4.35	6.48	4.26	178	172
820		195	640	731	6	4 540	10 300	230/560R	230/560RK	588	792	5	0.24	2.83	4.21	2.77	353	342
820		258	636	729	6	5 970	13 300	240/560R	240/560RK30	588	792	5	0.29	2.34	3.49	2.29	468	460
920		280	673	806	7.5	7 800	15 500	231/560R	231/560RK	596	884	6	0.31	2.20	3.27	2.15	763	740
1 030		365	713	877	9.5	11 500	21 900	232/560RR	232/560RRK	604	986	8	0.36	1.86	2.77	1.82	1 400	1 360
600		800	150	665	740	5	3 530	8 550	239/600R	239/600RK	622	778	4	0.17	3.94	5.87	3.86	218
	870	200	688	794	6	5 500	11 900	230/600RR	230/600RRK	628	842	5	0.22	3.08	4.59	3.02	405	393
	870	200	694	794	6	5 450	12 300	230/600RRHA	230/600RRHAK	628	842	5	0.21	3.24	4.83	3.17	406	394

[Remark] For bearings with lubrication holes and lubrication grooves on the outer ring, refer to page 367 and 368.

Spherical roller bearings

d (600) ~ 850 mm

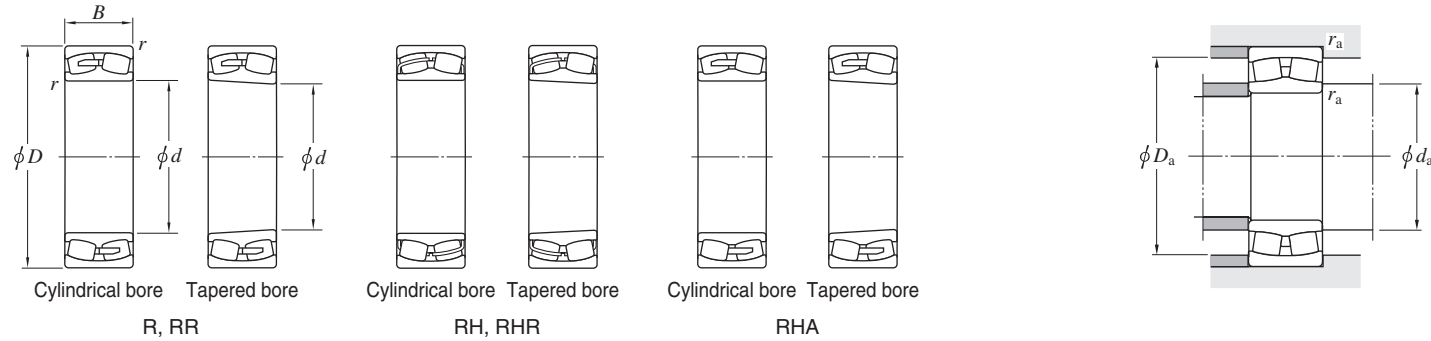

Boundary dimensions (mm)						Basic load ratings (kN)		Bearing No.		Mounting dimensions (mm)			Constant $e$	Axial load factors			(Refer.) Mass (kg)	
$d$	$D$	$B$	$d_1$ (Refer.)	$D_1$ (Refer.)	$r$ min.	$C_r$	$C_{0r}$	Cylindrical bore	Tapered bore	$d_a$ min.	$D_a$ max.	$r_a$ max.		$Y_1$	$Y_2$	$Y_0$	Cylindrical bore	Tapered bore
600	870	272	677	772	6	6 660	15 500	240/600R	240/600RK30	628	842	5	0.30	2.27	3.38	2.22	546	538
	980	300	717	857	7.5	9 040	18 400	231/600R	231/600RK	636	944	6	0.31	2.18	3.25	2.13	917	888
	980	375	706	833	7.5	10 200	21 600	241/600R	241/600RK30	636	944	6	0.38	1.77	2.63	1.73	1 120	1 100
	1 090	388	747	928	9.5	12 800	24 000	232/600R	232/600RK	644	1 046	8	0.36	1.85	2.76	1.81	1 640	1 590
630	850	165	704	787	6	4 050	9 680	239/630R	239/630RK	658	822	5	0.18	3.81	5.67	3.73	277	268
	920	212	724	831	7.5	5 770	12 800	230/630R	230/630RK	666	884	6	0.22	3.03	4.51	2.96	493	475
	920	212	725	838	7.5	6 000	13 000	230/630RHA	230/630RHAK	666	884	6	0.21	3.19	4.75	3.12	484	469
	920	290	716	818	7.5	7 410	17 200	240/630R	240/630RK30	666	884	6	0.29	2.30	3.42	2.25	659	650
	920	290	713	818	7.5	7 570	17 600	240/630RHA	240/630RHAK30	666	884	6	0.28	2.37	3.53	2.32	654	643
670	900	170	747	834	6	4 440	10 800	239/670R	239/670RK	698	872	5	0.17	3.92	5.83	3.83	317	308
	980	230	773	888	7.5	6 870	15 500	230/670R	230/670RK	706	944	6	0.22	3.01	4.47	2.94	609	589
	1 090	336	801	955	7.5	10 600	21 800	231/670R	231/670RK	706	1 054	6	0.31	2.17	3.23	2.12	1 270	1 240
	1 090	412	791	932	7.5	12 100	25 900	241/670R	241/670RK30	706	1 054	6	0.37	1.83	2.73	1.79	1 520	1 500
710	950	180	786	875	6	5 150	12 900	239/710R	239/710RK	738	922	5	0.17	3.89	5.79	3.80	365	353
	1 030	236	807	925	7.5	7 190	16 300	230/710R	230/710RK	746	994	6	0.22	3.05	4.54	2.98	681	657
	1 150	438	838	987	9.5	14 400	31 900	241/710R	241/710RK30	754	1 106	8	0.36	1.88	2.80	1.84	1 790	1 760
750	1 000	185	835	928	6	5 270	13 100	239/750R	239/750RK	778	972	5	0.17	4.00	5.95	3.91	410	396
	1 090	250	864	989	7.5	7 730	17 500	230/750R	230/750RK	786	1 054	6	0.22	3.14	4.67	3.07	809	781
	1 090	250	862	991	7.5	8 210	18 600	230/750RHA	230/750RHAK	786	1 054	6	0.21	3.20	4.76	3.12	799	775
	1 090	335	856	975	7.5	9 550	23 000	240/750R	240/750RK30	786	1 054	6	0.28	2.39	3.55	2.33	1 060	1 040
	1 220	365	890	1 063	9.5	13 300	28 000	231/750R	231/750RK	794	1 176	8	0.30	2.22	3.31	2.17	1 720	1 670
800	1 060	195	884	982	6	5 930	15 200	239/800R	239/800RK	828	1 032	5	0.17	4.02	5.99	3.93	480	464
	1 060	195	889	990	6	5 850	14 900	239/800RHA	239/800RHAK	828	1 032	5	0.15	4.47	6.65	4.37	480	464
	1 150	258	911	1 040	7.5	8 600	20 100	230/800R	230/800RK	836	1 114	6	0.21	3.15	4.69	3.08	909	876
850	1 120	200	936	1 038	6	6 410	16 700	239/850R	239/850RK	878	1 092	5	0.16	4.14	6.17	4.05	545	528
	1 220	272	972	1 110	7.5	9 570	22 600	230/850R	230/850RK	886	1 184	6	0.21	3.17	4.72	3.10	1 080	1 050

[Remark] For bearings with lubrication holes and lubrication grooves on the outer ring, refer to page 367 and 368.

$d$  900 ~ 1 400 mm

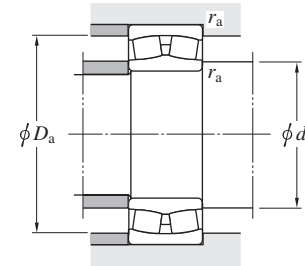
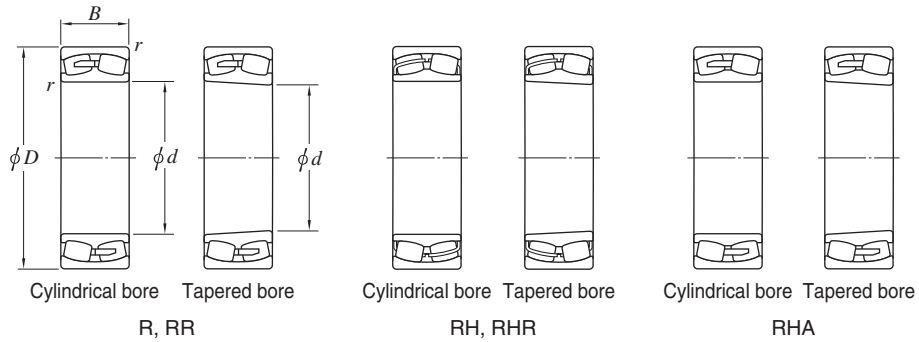

$d$	Boundary dimensions (mm)					Basic load ratings (kN)		Bearing No.		Mounting dimensions (mm)			Constant $e$	Axial load factors			(Refer.) Mass (kg)	
	$D$	$B$	$d_1$ (Refer.)	$D_1$ (Refer.)	$r$ min.	$C_r$	$C_{0r}$	Cylindrical bore	Tapered bore	$d_a$ min.	$D_a$ max.	$r_a$ max.		$Y_1$	$Y_2$	$Y_0$	Cylindrical bore	Tapered bore
<b>900</b>	1 180	206	989	1 095	6	6 850	18 100	<b>239/900R</b>	<b>239/900RK</b>	928	1 152	5	0.16	4.24	6.32	4.15	610	590
	1 280	280	1 019	1 160	7.5	10 300	24 800	<b>230/900R</b>	<b>230/900RK</b>	936	1 244	6	0.21	3.20	4.77	3.13	1 200	1 160
	1 420	412	1 049	1 241	12	16 800	37 100	<b>231/900R</b>	<b>231/900RK</b>	954	1 366	10	0.29	2.29	3.42	2.24	2 530	2 450
<b>950</b>	1 250	224	1 052	1 165	7.5	7 790	20 700	<b>239/950R</b>	<b>239/950RK</b>	986	1 214	6	0.16	4.15	6.18	4.06	755	731
	1 360	300	1 086	1 238	7.5	11 500	27 700	<b>230/950R</b>	<b>230/950RK</b>	986	1 324	6	0.21	3.20	4.77	3.13	1 470	1 420
<b>1 000</b>	1 220	165	1 078	1 160	6	4 640	13 600	<b>238/1000R</b>	—	1 028	1 192	5	0.12	5.65	8.42	5.53	410	396
	1 320	236	1 109	1 229	7.5	8 240	21 500	<b>239/1000R</b>	<b>239/1000RK</b>	1 036	1 284	6	0.16	4.14	6.16	4.05	895	866
	1 420	308	1 141	1 298	7.5	12 300	30 000	<b>230/1000R</b>	<b>230/1000RK</b>	1 036	1 384	6	0.21	3.26	4.85	3.18	1 620	1 570
<b>1 060</b>	1 400	250	1 176	1 304	7.5	9 500	25 300	<b>239/1060R</b>	<b>239/1060RK</b>	1 096	1 364	6	0.16	4.14	6.17	4.05	1 040	1 010
<b>1 120</b>	1 580	345	1 271	1 449	9.5	15 200	37 200	<b>230/1120R</b>	<b>230/1120RK</b>	1 164	1 536	8	0.21	3.28	4.88	3.21	2 190	2 120
<b>1 180</b>	1 540	272	1 302	1 439	7.5	10 900	29 800	<b>239/1180R</b>	<b>239/1180RK</b>	1 216	1 504	6	0.16	4.22	6.29	4.13	1 330	1 280
<b>1 400</b>	1 820	315	1 544	1 702	9.5	14 600	41 400	<b>239/1400R</b>	<b>239/1400RK</b>	1 444	1 776	8	0.16	4.32	6.43	4.22	2 230	2 160

[Remark] For bearings with lubrication holes and lubrication grooves on the outer ring, refer to page 367 and 368.

# Thrust ball bearings

■ Single direction

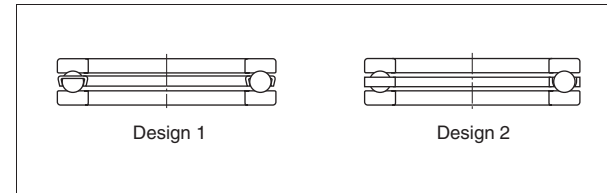

- Axial load can be accommodated in one direction.
- Although it is designed to carry high axial load, is not suitable for high-speed operation.
- The rolling elements normally contacts the shaft washer (or housing washer) with contact angle 90°.

<b>Boundary dimensions</b>	As specified in JIS B 1512.
<b>Tolerances</b>	As specified in JIS B 1514, class 0 or 6. (refer to Table 2-7 on page 26.)
<b>Allowable misalignment</b>	Misalignment not allowed.
<b>Amount of preload for thrust ball bearings</b>	<p>When a thrust ball bearing is rotated at high speed, balls slide on raceway due to centrifugal force and the gyro moment, which often causes the raceway to suffer from smearing or other defects.</p> <p>To eliminate such sliding, it is necessary to mount the bearing without clearance, and apply an axial load (preload) larger than the minimum necessary axial load determined by the following equation.</p> $F_{a \min} = 5.1 \left[ \frac{n}{1\,000} \right]^2 \cdot \left[ \frac{C_{0a}}{1\,000} \right]^2 \times 10^{-3} \dots\dots (\text{contact angle : } 90^\circ)$ <p>where :</p> <p><math>F_{a \min}</math> : minimum necessary axial load            N</p> <p><math>n</math> : rotational speed                                    min<sup>-1</sup></p> <p><math>C_{0a}</math> : static axial load rating                        N</p> <p>When an axial load from the outside is lower than 0.001 3 <math>C_{0a}</math>, there is no adverse effect on the bearing, as long as lubrication is satisfactory.</p> <p>Generally, deep groove and angular contact ball bearings are recommended for applications when a portion of rotation under axial load is present at high speed.</p>
<b>Standard cages</b>	Pressed cage (Design 1) or machined cage (Design 2)
<b>Equivalent axial load</b>	<p><b>Dynamic equivalent axial load</b> ..... <math>P_a = F_a</math></p> <p><b>Static equivalent axial load</b> ..... <math>P_{0a} = F_a</math></p>





d 100 ~ (160) mm

d (160) ~ (320) mm

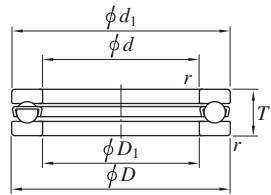

Design 1



Design 2

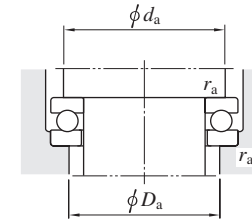

Boundary dimensions (mm)				Basic load ratings (kN)		Bearing No.	De-sign	Dimensions (mm)		Mounting dimensions (mm)			(Refer.) Mass (kg)
d	D	T	r min.	C <sub>a</sub>	C <sub>0a</sub>			d <sub>1</sub> max.	D <sub>1</sub> min.	d <sub>a</sub> min.	D <sub>a</sub> max.	r <sub>a</sub> max.	
<b>100</b>	135	25	1	85	268	<b>51120</b>	1	135	102	121	114	1	0.990
	150	38	1.1	146	410	<b>51220</b>	1	150	103	130	120	1	2.36
	170	55	1.5	236	595	<b>51320</b>	1	170	103	142	128	1.5	5.11
	210	85	3	368	983	<b>51420</b>	2	205	103	165	145	2.5	14.6
<b>110</b>	145	25	1	87	288	<b>51122</b>	1	145	112	131	124	1	1.08
	160	38	1.1	152	450	<b>51222</b>	1	160	113	140	130	1	2.57
	190	63	2	267	704	<b>51322</b>	2	187	113	158	142	2	7.72
	230	95	3	379	1 070	<b>51422</b>	2	225	113	181	159	2.5	19.8
<b>120</b>	155	25	1	89	305	<b>51124</b>	1	155	122	141	134	1	1.16
	170	39	1.1	154	470	<b>51224</b>	1	170	123	150	140	1	2.86
	210	70	2.1	311	869	<b>51324</b>	2	205	123	173	157	2	10.6
	250	102	4	480	1 460	<b>51424</b>	2	245	123	196	174	3	25.0
<b>130</b>	170	30	1	104	350	<b>51126</b>	1	170	132	154	146	1	1.87
	190	45	1.5	203	620	<b>51226</b>	1	187	133	166	154	1.5	4.09
	225	75	2.1	330	958	<b>51326</b>	2	220	134	186	169	2	13.0
	270	110	4	498	1 540	<b>51426</b>	2	265	134	212	188	3	31.4
<b>140</b>	180	31	1	107	375	<b>51128</b>	1	178	142	164	156	1	2.02
	200	46	1.5	205	650	<b>51228</b>	1	197	143	176	164	1.5	4.46
	240	80	2.1	365	1 130	<b>51328</b>	1	235	144	199	181	2	15.5
	280	112	4	520	1 680	<b>51428</b>	2	275	144	222	198	3	33.9
<b>150</b>	190	31	1	109	400	<b>51130</b>	1	188	152	174	166	1	2.15
	215	50	1.5	213	652	<b>51230</b>	2	212	153	189	176	1.5	5.64
	250	80	2.1	361	1 130	<b>51330</b>	2	245	154	209	191	2	16.3
	300	120	4	568	1 910	<b>51430</b>	2	295	154	238	212	3	41.6
<b>160</b>	200	31	1	112	425	<b>51132</b>	1	198	162	184	176	1	2.28
	225	51	1.5	223	718	<b>51232</b>	2	222	163	199	186	1.5	6.53

Boundary dimensions (mm)				Basic load ratings (kN)		Bearing No.	De-sign	Dimensions (mm)		Mounting dimensions (mm)			(Refer.) Mass (kg)
d	D	T	r min.	C <sub>a</sub>	C <sub>0a</sub>			d <sub>1</sub> max.	D <sub>1</sub> min.	d <sub>a</sub> min.	D <sub>a</sub> max.	r <sub>a</sub> max.	
<b>160</b>	270	87	3	410	1 340	<b>51332</b>	2	265	164	225	205	2.5	21.0
	320	130	5	681	2 410	<b>51432</b>	2	315	164	254	226	4	51.2
<b>170</b>	215	34	1.1	134	510	<b>51134</b>	1	213	172	197	188	1	3.25
	240	55	1.5	261	834	<b>51234</b>	2	237	173	212	198	1.5	8.12
	280	87	3	463	1 570	<b>51334</b>	2	275	174	235	215	2.5	22.0
	340	135	5	755	2 730	<b>51434</b>	2	335	174	270	240	4	60.0
<b>180</b>	225	34	1.1	135	525	<b>51136</b>	1	222	183	207	198	1	3.39
	250	56	1.5	265	874	<b>51236</b>	2	247	183	222	208	1.5	8.68
	300	95	3	463	1 580	<b>51336</b>	2	295	184	251	229	2.5	28.1
<b>190</b>	240	37	1.1	170	655	<b>51138</b>	1	237	193	220	210	1	3.95
	270	62	2	308	1 060	<b>51238</b>	2	267	194	238	222	2	11.7
	320	105	4	543	1 950	<b>51338</b>	2	315	195	266	244	3	36.0
<b>200</b>	250	37	1.1	172	675	<b>51140</b>	1	247	203	230	220	1	4.13
	280	62	2	314	1 110	<b>51240</b>	2	277	204	248	232	2	12.2
	340	110	4	596	2 220	<b>51340</b>	2	335	205	282	258	3	42.9
<b>220</b>	270	37	1.1	177	740	<b>51144</b>	1	267	223	250	240	1	4.50
	300	63	2	342	1 310	<b>51244</b>	2	297	224	268	252	2	13.5
<b>240</b>	300	45	1.5	241	1 020	<b>51148</b>	2	297	243	276	264	1.5	7.38
	340	78	2.1	442	1 800	<b>51248</b>	2	335	244	299	281	2	23.1
<b>260</b>	320	45	1.5	231	990	<b>51152</b>	2	317	263	296	284	1.5	7.93
	360	79	2.1	445	1 880	<b>51252</b>	2	355	264	319	301	2	25.0
<b>280</b>	350	53	1.5	329	1 430	<b>51156</b>	2	347	283	322	308	1.5	12.0
<b>300</b>	380	62	2	363	1 610	<b>51160</b>	2	376	304	348	332	2	17.5
	420	95	3	570	2 600	<b>51260</b>	2	415	304	371	349	2.5	42.5
<b>320</b>	400	63	2	379	1 760	<b>51164</b>	2	396	324	368	352	2	19.0

# Single direction thrust ball bearings

$d$  (320) ~ 600 mm

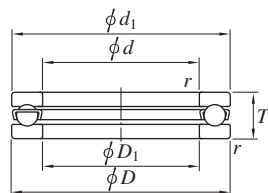

Design 1



Design 2

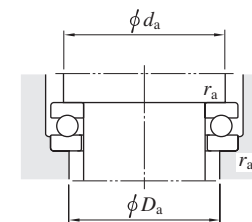

Boundary dimensions (mm)				Basic load ratings (kN)		Bearing No.	De-sign	Dimensions (mm)		Mounting dimensions (mm)			(Refer.) Mass (kg)
$d$	$D$	$T$	$r_{min.}$	$C_a$	$C_{0a}$			$d_1$ max.	$D_1$ min.	$d_a$ min.	$D_a$ max.	$r_a$ max.	
320	440	95	3	577	2 710	51264	2	435	325	391	369	2.5	45.0
	460	96	3	584	2 830								
340	420	64	2	387	1 860	51168	2	416	344	388	372	2	20.5
	460	96	3	584	2 830								
360	440	65	2	394	1 960	51172	2	436	364	408	392	2	21.5
	500	110	4	701	3 500								
380	460	65	2	395	2 010	51176	2	456	384	428	412	2	23.0
	520	112	4	712	3 650								
400	480	65	2	402	2 110	51180	2	476	404	448	432	2	24.0
	540	112	4	722	3 810								
420	500	65	2	410	2 210	51184	2	495	424	468	452	2	25.0
	580	130	5	818	4 420								
440	540	80	2.1	522	2 930	51188	2	535	444	499	481	2	41.5
	600	130	5	832	4 620								
460	560	80	2.1	524	3 000	51192	2	555	464	519	501	2	43.0
	620	130	5	847	4 830								
480	580	80	2.1	535	3 150	51196	2	575	484	539	521	2	44.0
500	600	80	2.1	546	3 300	511/500	2	595	505	559	541	2	46.0
530	640	85	3	603	3 750	511/530	2	635	535	595	575	2.5	57.5
560	670	85	3	613	3 930	511/560	2	665	565	625	605	2.5	60.5
600	710	85	3	628	4 200	511/600	2	705	605	665	645	2.5	64.0

# Tapered roller thrust bearings



- Tapered roller thrust bearings come in three types, single direction type, double direction type, and screw-down spindle type (single direction full complement type). They are suitable for extremely heavy axial load and impact load.
- The housing washer and shaft washer raceways are so designed that the extension lines of both raceways intersect at one point on the bearing centerline axis which promotes geometrically true rolling motion of the rolling elements.
- The contact areas between the rib provided for shaft washer and/or housing washer and the spherically ground roller large end face are designed so that the rollers can be guided securely, and proper oil film is formed.

■ Single direction (page 404)

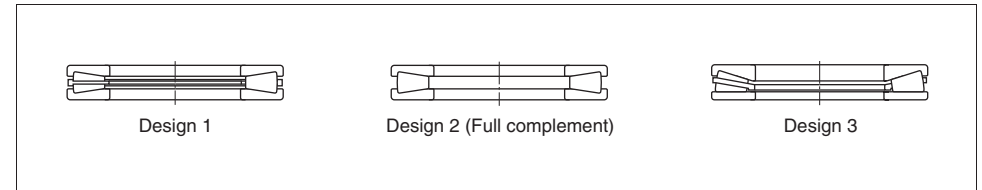

- Bearings having ribs for both shaft and housing washers are suitable for the locations where the bearings can be securely fixed in radial direction, and mainly used for crane hook and swivel of oil excavator.
- If extremely heavy axial load is required, use the full complement type bearings (Design 2).
- Bearings having flat housing washer raceway (Design 3) allow some misalignment of shaft (against housing hole) during rotation.

■ Double direction (page 408)

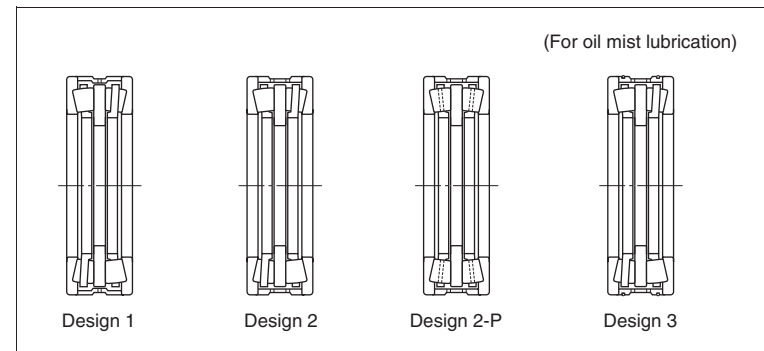

- The bearing of this type can support axial load in both directions, and is mainly used to support the axial load on roll neck of rolling mills.
- Since the shaft washer is treated with a clearance fit to the shaft, the shaft washer must be tightened and fixed securely with a sleeve.
- The axial clearance is commonly adjusted by means of spacer. The bearing without spacer is pre-loaded by spring, etc. for use.
- Some bearings have lubrication holes and O-rings on the spacer for oil mist lubrication.

■ For screw down spindles (Single direction full complement)

THR ... Type (page 412)

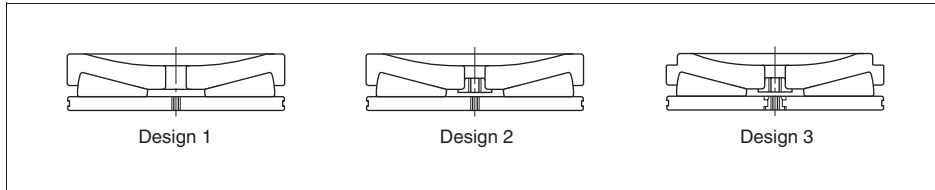

THR ... X Type (page 414)



- The bearings, suitable for low-speed and heavy load, have been designed for screw down spindles.
- The shaft washer surface is ground to convex or concave spherical surface to suit the profiles of the shaft end faces of screw-down spindles.
- Since the spherical shaft washer surface supports screw-down spindles, some misalignment of screw-down spindles during rotation is allowable. Some spindle runout is also allowable, since the housing washer raceway is designed flat.

- The bearings can be handled easily, as the shaft washer has the lifting hole in the center (some bearings have lifting nuts in the lifting holes: Design 2, 3, 5), and the housing washer also has lifting tapped hole.
- In many cases, housing washer is fixed to the housing with full dog point set screws. Thus, the outside surface is equipped with a groove to receive the tip of the set screws.

<b>Boundary dimensions</b>	Custom-manufactured to dimensions required for specific equipment.
<b>Tolerances</b>	Consult with JTEKT, as special tolerances are adopted for specific application. Generally equivalent to class 0 specified in JIS (refer to Table 2-8 on page 27).
<b>Misalignment</b>	No misalignment is allowable.
<b>Standard cage</b>	Machined cage
<b>Equivalent load</b>	<b>Dynamic equivalent load</b> ..... $P_a = F_a$ <b>Static equivalent load</b> ..... $P_{0a} = F_a$

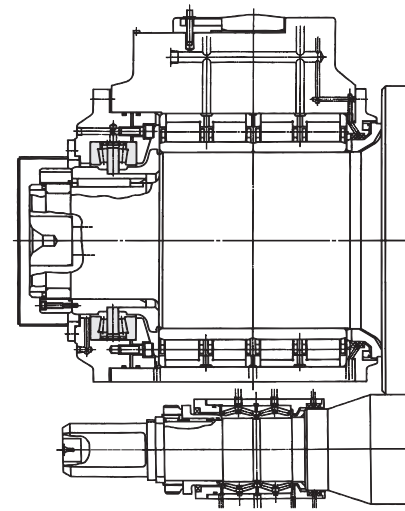

Mounting example of double direction tapered roller thrust bearing on the rolling mill roll neck

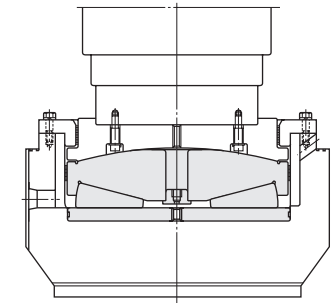

Mounting example of tapered roller thrust bearing for screw down spindle

# Single direction tapered roller thrust bearings

d 114.3 ~ 254 mm

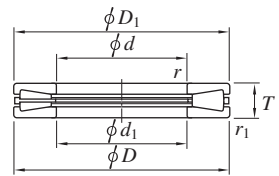

Design 1



Design 1-1

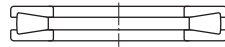

Design 2

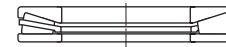

Design 3

Boundary dimensions										Basic load ratings (kN)		Bearing No.	Design	Max. fillet radius (mm)		Mass (kg)	
d	D	T	D <sub>1</sub>	d <sub>1</sub>	r <sup>1)</sup>	r <sub>1</sub> <sup>1)</sup>	C <sub>a</sub>	C <sub>0a</sub>	Shaft r <sub>a</sub>	Housing r <sub>b</sub>							
mm	1/25.4	mm	1/25.4	mm	1/25.4	mm	mm	mm	mm	mm	mm	mm	mm	mm	mm	mm	mm
114.3	—	250	—	53.975	—	250	114.3	4	4	959	3 960	THR2325	1	—	—	14.0	
115	—	280	—	70	—	280	117	6	6	1 300	5 160	T232807	1	—	—	24.0	
152.400	6.0000	317.500	12.5000	69.850	2.7500	317.500	152.400	6.4	6.4	1 520	6 530	T611	1	4	4	31.0	
152.4	—	317.5	—	69.85	—	317.5	152.7	6.4	6.4	1 500	6 290	THR303207A	3	—	—	29.0	
152.400	6.0000	317.500	12.5000	69.850	2.7500	317.500	152.400	6.4	6.4	1 990	9 410	T611V	2	4	4	31.0	
168.275	6.6250	304.800	12.0000	69.850	2.7500	304.800	168.275	6.4	6.4	1 310	5 170	T661	1	4	4	25.0	
	6.6250	304.800	12.0000	69.850	2.7500	302.500	169.000	6.4	6.4	1 190	4 530	THR343007A	3	4	4	24.0	
174.625	6.8750	358.775	14.1250	82.550	3.2500	358.775	174.625	6.4	6.4	1 950	8 570	T691	1	4	4	45.0	
	6.8750	358.775	14.1250	82.550	3.2500	358.775	174.625	6.4	6.4	2 440	11 500	T691V	2	4	4	46.0	
177.800	7.0000	368.300	14.5000	82.550	3.2500	368.300	177.800	7.9	7.9	2 070	9 150	T711	1	5	5	48.0	
180	—	360	—	109	—	358	190	6	6	2 250	7 690	THR363611	3	—	—	47.0	
203.200	8.0000	419.100	16.5000	92.075	3.6250	419.100	203.200	9.5	9.5	2 590	11 600	T811	1	6	6	69.0	
203.2	—	419.1	—	92.075	—	416.7	203.2	9.5	9.5	2 560	11 200	THR404292	3	—	—	68.0	
228.600	9.0000	482.600	19.0000	104.775	4.1250	482.600	228.600	SP	11.2	3 390	16 300	T911	1-1	7	7	107	
234.950	9.2500	546.100	21.5000	127.000	5.0000	546.100	234.950	15.9	15.9	4 470	21 500	T921	1	11	11	174	
	9.2500	546.100	21.5000	127.000	5.0000	546.100	234.950	15.9	15.9	5 560	28 400	T921V	2	11	11	175	
241	—	404	—	110	—	404	241	5	5	2 200	8 140	THR484011	3	3	3	62.0	
241.300	9.5000	496.888	19.5625	129	5.0787	496.888	241.300	SP	SP	3 420	15 600	THR4850129	1	5	5	137	
254	—	539.75	—	117.48	—	539.75	254	11.1	11.1	4 130	20 200	THR515412	3	—	—	143	

[Note] 1) SP indicates the specially chamfered form.

# Single direction tapered roller thrust bearings

$d$  279.400 ~ 830 mm

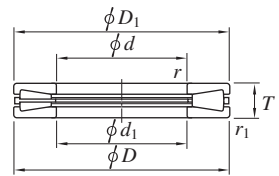

Design 1



Design 1-1

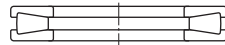

Design 2



Design 3

Boundary dimensions										Basic load ratings (kN)		Bearing No.	Design	Max. fillet radius (mm)		Mass (kg)
$d$ mm		$D$ mm		$T$ mm		$D_1$ mm	$d_1$ mm	$r^{1)}$	$r_1^{1)}$	$C_a$	$C_{0a}$			Shaft $r_a$	Housing $r_b$	
279.400	11.0000	603.250	23.7500	136.520	5.3748	603.250	279.400	SP	11.1	5 520	26 800	T1120	1-1	7	7	210
	11.0000	603.250	23.7500	136.520	5.3748	603.250	279.700	11.1	11.1	7 120	37 800					
290	—	395	—	80	—	395	291	SP	SP	1 200	4 780	THR584008	3	2.5	2.5	30.0
300	—	663.5	—	165	—	658	306	12	12	6 370	30 000	THR6066	3	—	—	312
340	—	460	—	96	—	460	340	4	4	1 510	6 960	THR684610	3	—	—	53.6
406.4	—	711.2	—	146.05	—	711.2	406.4	SP	9.7	6 470	32 500	T16021	1-1	—	—	256
609.6	—	812.8	—	101.6	—	812.8	609.6	SP	SP	4 400	27 300	THR610	3	—	—	152
749.3	—	955.975	—	127	—	952.5	749.8	5.1	5.1	5 590	30 500	THR749	3	2	2	230
830	—	1 010	—	80	—	1 010	830	5	5	2 790	20 300	THR830	1	—	—	136

[Note] 1) SP indicates the specially chamfered form.

Double direction tapered roller thrust bearings

d 94 ~ (380) mm

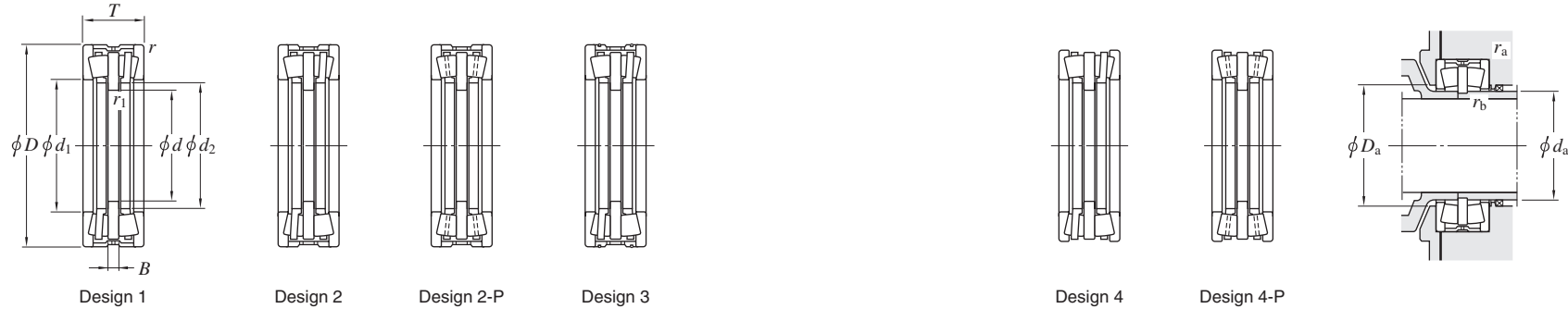

Boundary dimensions (mm)								Basic load ratings (kN)		Bearing No.	Design	Mounting dimensions (mm)				Mass (kg)
d	D	T	B	d <sub>1</sub>	d <sub>2</sub>	r	r <sub>1</sub>	C <sub>a</sub>	C <sub>0a</sub>			d <sub>a</sub> min.	D <sub>a</sub> max.	r <sub>a</sub> max.	r <sub>b</sub> max.	
94	190	76	16	116	112	2.5	2.5	289	988	2THR191908	2	109	121	1.5	1.5	9.50
160	280	130	50	190	190	2	1.5	658	2 950	2THR322813	1	184	196	1	1	33.0
170	240	84	20	184	182	4	1.5	321	1 310	2THR342408A	2	179	192	2.5	0.8	12.0
	240	84	20	184	182	4	1.5	367	1 400	2THR342408B	2	176	190	3	1	12.0
180	280	90	20	210	205	2	1	640	2 710	2THR362809A	4	199	216	1	0.5	19.0
	400	200	50	210	210	3	1	2 450	9 620	2THR364020	2	204	216	2	0.5	130
200	430	231	100	260	254	4	1.5	1 930	9 470	2THR404323-1	2	245	266	3	1	170
220	300	96	26	240	232	2	1	541	2 350	2THR443010	1	226	246	1	0.5	19.0
	300	96	22	240	232	2	1	541	2 350	2THR443010A	1	226	246	1	0.5	18.0
	340	130	39	250	245.6	2	1	922	3 870	2THR443413	4	239.6	256	1	0.5	40.0
	372	195	75	254	246	4	1.5	1 510	6 280	2THR443720	4	240	260	3	1	85.0
250	380	100	22	275	270	2	1.1	906	4 840	2THR503810	1	264	281	1	0.5	40.0
260	360	92	20	285	276	2	1	722	3 630	2THR52369	2	270	291	1	0.5	25.0
	360	92	20	285	276	2	1	722	3 630	2THR52369/DP	3	270	291	1	0.5	25.0
	400	120	25	290	280	4	2	1 210	5 820	2THR524012	2	276	298	2.5	1	50.0
291	520	266	118	349	349	12	2	2 130	10 800	2THR585227	2	343	357	10.5	1.5	245
320	440	108	20	355	349	4	2.5	881	4 570	2THR644411	1	344	363	2.5	1	45.0
	470	130	30	350	340	3	1	1 310	6 080	2THR644713	2	334	358	1.5	0.5	70.0
350	490	130	30	390	380	3	1	1 290	6 200	2THR704913A	1	374	398	1.5	0.5	70.0
	490	130	30	390	380	3	1	1 290	6 200	2THR704913A/DP	3	374	398	1.5	0.5	70.0
	490	130	30	390	380	4	2	1 290	6 200	2THR704913A/DP1	3	375	398	2.5	1	70.0
351	670	308	120	435	430	12	3	3 460	19 500	2THR706731	1	424	443	10	2	505
	670	319	131	435	430	12	3	3 460	19 500	2THR706732	1	424	443	10	2	505
380	560	130	32	430	416	3	1.5	1 570	8 860	2THR765613	2	410	438	1.5	0.5	110

Double direction tapered roller thrust bearings

$d$  (380) ~ 550 mm

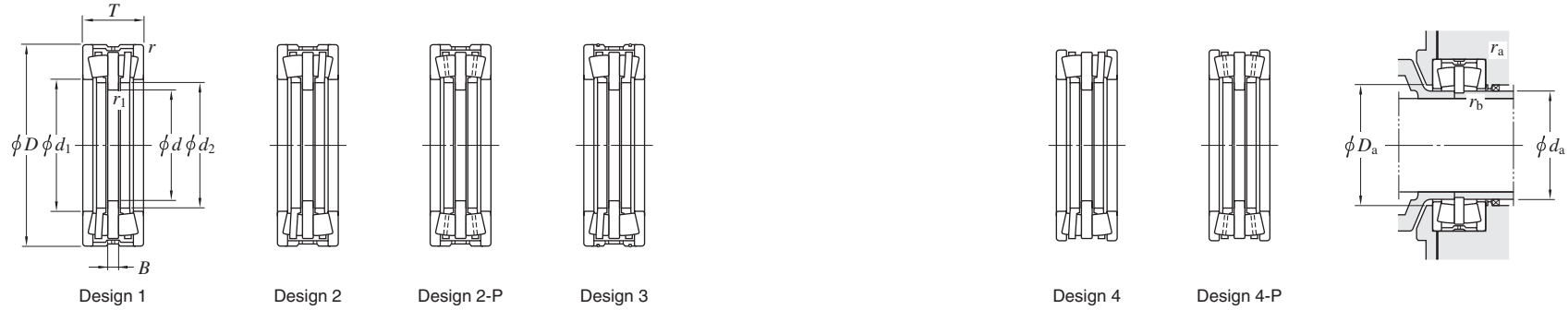

Boundary dimensions (mm)								Basic load ratings (kN)		Bearing No.	Design	Mounting dimensions (mm)				Mass (kg)
$d$	$D$	$T$	$B$	$d_1$	$d_2$	$r$	$r_1$	$C_a$	$C_{0a}$			$d_a$ min.	$D_a$ max.	$r_a$ max.	$r_b$ max.	
380	560	130	32	430	416	3	1.5	1 570	8 860	2THR765613A 2THR765613A/DP	3 3	410 410	438 438	1.5 2.5	0.5 1.5	110 100
	560	130	32	430	416	4	2.5	1 570	8 860							
420	620	170	35	465	455	3	1.5	2 570	14 000	2THR846217 2THR846524	2-P 2-P	449 480	473 504	1.5 2	0.5 1	160 260
	650	235	85	496	486	4	1.5	2 760	14 500							
440	650	240	90	492.5	485	7	1.5	2 870	15 200	2THR886524	4	479	502	5	0.5	270
470	720	200	40	535	516	5	3	3 490	19 700	2THR947220	2-P	508	545	3	2	270
482	680	250	90	535	524	7	2	3 090	16 000	2THR966825	4-P	516	545	5	1	280
520	860	382	168	625	610	20	2	5 220	32 800	2THR520	2-P	602	635	15	1	850
550	760	230	50	610	590	5	2	2 900	15 000	2THR550	2-P	580	622	3	1	290



Tapered roller thrust bearings for screw down spindle

THR...type (Full complement)

D 149.225 ~ 641.350 mm

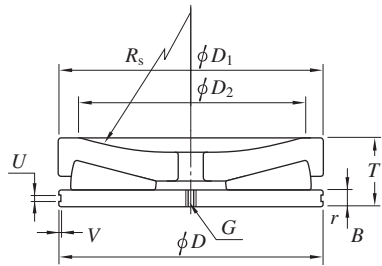

Design 1

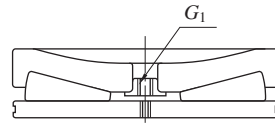

Design 2

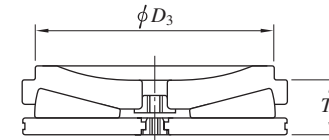

Design 3

Boundary dimensions									Basic load ratings (kN) C <sub>0a</sub>	Bearing No.	Design	Dimensions (mm)							Mass (kg)	
D mm	<sup>1/25.4</sup> D <sub>1</sub> mm	<sup>1/25.4</sup> D <sub>2</sub> mm	<sup>1/25.4</sup> T mm	<sup>1/25.4</sup> r	R <sub>s</sub>	B	D <sub>3</sub>	T <sub>1</sub>				U	V	G	G <sub>1</sub>					
<b>149.225</b>	5.8750	146.863	5.7820	127.0	5.0000	47.625	1.8750	1.6	2 190	<b>THR149</b>	1	228.6	12.700	—	—	4.8	1.2	M12	—	6.00
<b>174.625</b>	6.8750	172.263	6.7820	152.4	6.0000	52.375	2.0620	1.6	2 860	<b>THR175</b>	2	230.0	12.700	—	—	4.8	1.2	M12	M16	8.00
<b>203.200</b>	8.0000	200.838	7.9070	177.8	7.0000	65.075	2.5620	1.6	3 970	<b>THR203</b>	1	254.0	15.875	—	—	6.35	1.2	M12	—	14.0
<b>266.700</b>	10.5000	264.338	10.4070	228.6	9.0000	80.963	3.1875	1.6	7 490	<b>THR267-2</b>	1	250	19.050	—	—	7.9	2.0	M20	—	30.0
<b>320.675</b>	12.6250	318.313	12.5320	279.4	11.0000	95.250	3.7500	1.6	11 700	<b>THR321</b>	1	381.0	22.225	—	—	10.3	2.4	M20	—	50.0
<b>377.825</b>	14.8750	375.463	14.7820	330.2	13.0000	111.125	4.3750	1.6	15 600	<b>THR378</b>	2	457.2	25.400	—	—	10.3	2.4	M24	M42	80.0
<b>409.575</b>	16.1250	407.162	16.0300	330.2	13.0000	139.700	5.5000	3.2	18 700	<b>THR410A</b>	2	508.0	28.575	—	—	10.3	2.4	M24	M30	120
	16.1250	407.213	16.0320	355.5	13.9961	122.225	4.8120	3.2	18 700	<b>THR410</b>	2	508.0	28.575	—	—	10.3	2.4	M24	M30	120
<b>438.150</b>	17.2500	435.788	17.1570	381.0	15.0000	130.175	5.1250	3.2	21 500	<b>THR438</b>	2	568.0	31.750	—	—	13.5	3.2	M24	M24	130
<b>495.300</b>	19.5000	492.938	19.4070	431.8	17.0000	146.050	5.7500	3.2	28 000	<b>THR495A</b>	2	558.8	34.925	—	—	12.7	3.175	M24	M24	190
<b>524.000</b>	20.6299	520.000	20.4724	457.2	18.0000	152.400	6.0000	3.2	32 700	<b>THR524</b>	1	635.0	34.925	—	—	13.5	3.2	(W1)	—	220
<b>551.637</b>	21.7180	539.750	21.2500	406.4	16.0000	158.750	6.2500	1	32 900	<b>THR550A</b>	3	635.0	25.400	495.3	117.064	10.31	2.39	M24	M30	230
	21.7180	539.750	21.2500	406.4	16.0000	158.750	6.2500	1.5	32 900	<b>THR550A-1</b>	2	635.0	25.400	495.3	117.064	10.31	2.39	M24	M30	250
	21.7180	539.750	21.2500	434.975	17.1250	158.750	6.2500	1.5	32 900	<b>THR550</b>	3	635.0	25.400	495.3	115.888	9.525	2.54	M24	M30	250
<b>581.025</b>	22.8750	578.663	22.7820	508.0	20.0000	168.275	6.6250	3.2	38 400	<b>THR581</b>	2	711.2	38.100	—	—	13.5	3.2	M24	M42	300
<b>609.600</b>	24.0000	609.600	24.0000	436.0	17.1654	177.800	7.0000	3.2	44 600	<b>THR610A</b>	2	635.0	38.100	—	—	13.5	3.2	M24	M30	350
	24.0000	607.240	23.9071	—	—	177.800	7.0000	3.2	44 600	<b>THR610D</b>	2	—	38.100	—	—	13.5	3.2	M24	M30	390
	24.0000	609.600	24.0000	436.0	17.1654	177.800	7.0000	3.2	44 600	<b>THR610M</b>	3	635.0	38.100	560.0	87.800	13.5	3.2	M24	M30	340
<b>615.200</b>	24.2200	607.000	23.8976	—	—	161.800	6.3701	3	44 600	<b>THR615</b>	2	—	38.100	—	—	13.0	3.5	M24	M30	330
<b>641.350</b>	25.2500	638.988	25.1570	558.8	22.0000	184.150	7.2500	3.2	49 400	<b>THR641</b>	2	762.0	38.100	—	—	13.5	3.2	M24	M30	400

# Tapered roller thrust bearings for screw down spindle

## THR...X type (Full complement)

D 149.225 ~ 520.000 mm

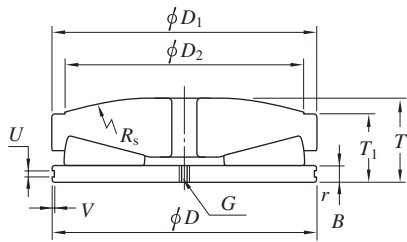

Design 1

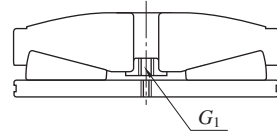

Design 2

Boundary dimensions					Basic load ratings		Design	Dimensions (mm)							Mass (kg)				
D	D <sub>1</sub>	D <sub>2</sub>	T	r	C <sub>0a</sub>	Bearing No.		B	T <sub>1</sub>	R <sub>s</sub>	U	V	G	G <sub>1</sub>					
mm	1/25.4	mm	1/25.4	mm	1/25.4	mm	1/25.4	mm	mm	mm	mm	mm	mm	mm	mm	mm	mm	mm	mm
149.225	5.8750	146.863	5.7820	127.0	5.0000	54.528	2.1468	1.6	2 190	THR149X	1	12.700	47.625	457.2	4.8	1.2	M12	—	6.00
174.625	6.8750	172.263	6.7820	152.4	6.0000	60.702	2.3901	1.6	2 860	THR175X	2	12.700	52.375	457.2	4.8	1.2	M12	M16	10.0
	6.8750	172.263	6.7820	152.4	6.0000	61.001	2.4016	1.6	2 860	THR175X-1	1	12.700	52.388	800.0	4.8	1.2	W 1/2	—	10.0
	6.8750	174.549	6.8720	152.4	6.0000	60.708	2.3901	1.6	2 860	THR175X-2	2	12.700	52.375	457.0	4.8	1.2	M12	M16	10.0
203.200	8.0000	200.838	7.9070	177.8	7.0000	74.729	2.9421	1.6	3 970	THR203X	1	15.875	65.075	508.0	6.35	1.2	M12	—	16.0
	8.0000	200.838	7.9070	177.8	7.0000	74.729	2.9421	1.6	3 970	THR203X-1	2	15.875	65.075	508.0	6.35	1.2	M12	M8	16.0
266.700	10.5000	264.338	10.4070	228.6	9.0000	93.491	3.6807	1.6	7 730	THR267X	1	19.050	80.963	609.6	7.9	2.0	M20	—	35.0
	10.5000	264.338	10.4070	228.6	9.0000	93.491	3.6807	1.6	7 730	THR267X-2	2	19.050	80.963	609.6	7.9	2	M20	M30	35.0
275.000	10.8288	270.000	10.6299	234.0	9.2126	98.994	3.8974	3.0	4 250	THR275X	1	20.000	85.000	609.6	—	—	—	—	40.0
320.675	12.6250	318.313	12.5320	279.4	11.0000	109.922	4.3276	1.6	11 700	THR321AX	2	22.225	95.250	762.0	10.3	2.4	M36	M42	60.0
	12.6250	318.313	12.5320	279.4	11.0000	109.922	4.3276	1.6	11 700	THR321BX	2	22.225	95.250	762.0	—	—	M36	M42	60.0
	12.6250	318.313	12.5320	279.4	11.0000	110.382	4.3457	1.6	11 700	THR321X	1	22.225	95.250	762.0	10.3	2.4	M20	—	60.0
377.825	14.8750	375.463	14.7820	330.2	13.0000	127.639	5.0251	1.6	15 600	THR378X	2	25.400	111.125	914.4	10.3	2.4	M24	M42	95.0
409.575	16.1250	407.213	16.0320	355.6	14.0000	139.979	5.5110	3.2	18 700	THR410X	2	28.575	122.225	1 016.0	10.3	2.4	M24	M30	120
438.150	17.2500	435.788	17.1570	381.0	15.0000	149.442	5.8835	3.2	21 500	THR438X	2	31.750	130.175	1 016.0	13.5	3.2	M12	M24	150
	17.2500	435.788	17.1570	381.0	15.0000	149.882	5.9009	3.2	21 500	THR438X-4	2	31.750	130.175	1 066.8	—	—	M12	M24	150
482.600	19.0000	480.210	18.9059	432.0	17.0078	144.065	5.6718	3.2	24 600	THR483XC	2	38.100	130.180	1 905.0	13.5	3.2	M24	M30	180
490.220	19.3000	492.938	19.4070	431.8	17.0000	169.440	6.6709	3.2	28 000	THR495X-1	1	34.925	146.050	1 066.8	12.7	3.2	M24	—	220
	19.3000	492.938	19.4070	431.8	17.0000	169.440	6.6709	3.2	28 000	THR495X-2	2	34.925	146.050	1 066.8	12.7	3.2	M24	M30	220
495.300	19.5000	492.938	19.4070	431.8	17.0000	169.440	6.6709	3.2	28 000	THR495X	1	34.925	146.050	1 066.8	13.5	3.3	M24	—	220
	19.5000	492.938	19.4070	431.8	17.0000	169.440	6.6709	3.3	28 000	THR495X-3	2	34.925	146.050	1 066.8	13.5	3.3	M24	M30	240
514.350	20.2500	521.386	20.5270	403.2	15.8740	188.712	7.4296	1.6	32 700	THR521X	2	34.925	154.813	635.0	—	—	W1	W1-1/4	250
520.000	20.4724	521.513	20.5320	457.2	18.0000	174.783	6.8812	3.2	32 700	THR524X-1	1	34.925	152.400	1 270.0	12.7	3.2	M24	—	250

Tapered roller thrust bearings for screw down spindle

THR...X type (Full complement)

D 523.875 ~ 900.000 mm

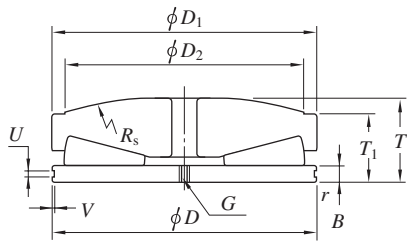

Design 1

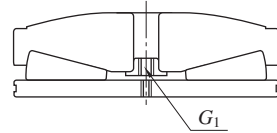

Design 2

Boundary dimensions					Basic load ratings (kN)		Design	Dimensions (mm)							Mass (kg)				
D	D <sub>1</sub>	D <sub>2</sub>	T	r	C <sub>0a</sub>	Bearing No.		B	T <sub>1</sub>	R <sub>s</sub>	U	V	G	G <sub>1</sub>					
mm	1/25.4	mm	1/25.4	mm	1/25.4	mm	1/25.4	mm	mm	mm	mm	mm	mm	mm					
523.875	20.6250	521.513	20.5320	457.2	18.0000	174.783	6.8812	3.2	32 700	THR524X	1	34.925	152.400	1 270.0	13.5	3.2	M24	—	250
533.400	21.0000	531.010	20.9059	457.2	18.0000	177.169	6.9752	1.6	32 700	THR533X	2	31.750	161.920	1 981.2	9.5	6	M24	M36	270
555.625	21.8750	553.260	21.7819	482.6	19.0000	189.438	7.4582	3.2	36 300	THR556AX	2	38.100	165.100	1 295.4	12.7	3.2	1-8UNC	1*1/4-7UNC	305
	21.8750	553.260	21.7819	482.6	19.0000	189.438	7.4582	3.2	36 300	THR556BX	2	38.100	165.100	1 270	—	—	M24	M36	310
	21.8750	553.260	21.7819	482.6	19.0000	189.438	7.4582	3.2	36 300	THR556D-2X	2	38.100	165.100	1 270	11	6.7	M24	M36	320
	21.8750	553.260	21.7819	482.6	19.0000	189.438	7.4582	3.2	36 300	THR556X-1	2	38.100	165.100	1 295.4	12.7	3.2	M24	M36	305
581.025	22.8750	578.663	22.7820	508.0	20.0000	192.511	7.5792	3.2	38 400	THR581X	2	38.100	168.275	1 422.4	13.5	3.2	M24	M42	340
	22.8750	578.663	22.7820	508.0	20.0000	196.650	7.7421	3.2	38 400	THR581X-3	2	38.100	168.275	1 308.1	13.5	3.2	M24	M42	350
609.600	24.0000	607.238	23.9070	533.4	21.0000	202.831	7.9855	3.2	44 600	THR610X	2	38.100	177.800	1 524.0	13.5	3.2	M24	M30	390
	24.0000	607.238	23.9070	533.4	21.0000	202.831	7.9855	3.2	44 600	THR610X-1	2	38.100	177.800	1 524.0	13.5	3.2	M30	M42	390
641.350	25.2500	638.988	25.1570	553.8	21.8031	211.492	8.3264	3.2	49 400	THR641X	2	38.100	184.150	1 524.0	13.5	3.2	M24	M30	450
	25.2500	638.988	25.1570	558.8	22.0000	211.854	8.3407	3	49 400	THR641CX	2	38.100	184.150	1 524.0	—	—	M24	M42	460
710.000	27.9527	710.000	27.9527	630.0	24.8031	259.107	10.2011	3.5	54 900	THR710XA	2	40.000	200.000	1 400.0	—	—	M24	M48	680
800.000	31.4960	798.000	31.4173	720.0	28.3464	260.268	10.2468	5	71 800	THR800X	2	50.000	214.000	1 524.0	—	—	M30	M30	870
	31.4960	840.000	33.0708	740.0	29.1338	265.000	10.4330	7	77 800	THR840X	2	50.000	221.000	1 800.0	—	—	M36	M48	940
847.600	33.3700	841.000	33.1102	650.0	25.5905	248.000	9.7638	5	77 800	THR848X	2	43.000	212.000	1 652.0	—	—	M42	M42	930
	33.3700	841.000	33.1102	650.0	25.5905	248.000	9.7638	5	77 800	THR848X-1	2	43.000	212.000	1 652.0	—	—	M36	M42	890
900.000	35.4330	900.000	35.4330	870.0	34.2520	228.739	9.0055	2	81 100	THR900X	2	40.000	177.840	1 800.0	11.0	7.5	M24	M48	970
	35.4330	930.000	36.6142	820.0	32.2835	275.000	10.8268	5	98 200	THR930XB	2	60.000	223.000	1 800.0	—	—	M36	M48	1 170

# Spherical thrust roller bearings

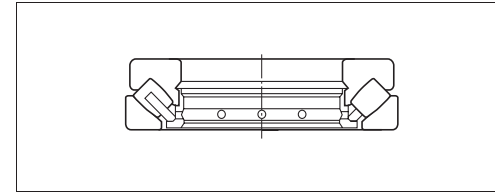

- Spherical thrust roller bearings are designed to carry high axial loads. They can also support radial load if magnitude is no more than 55 % of the axial load being carried.
- Having a spherical housing washer raceway surface, these bearings are self-alignings.
- These bearings are not suitable for high-speed rotation. In general, they are used with oil lubrication.

<b>Boundary dimensions</b>	As specified in JIS B 1512.
<b>Tolerances</b>	As specified in JIS B 1514, class 0. (refer to Table 2-8 on page 27.)
<b>Allowable aligning angle</b>	0.035 – 0.052 rad (2° – 3°) in general, depending on bearing series.
<b>Amount of preload for spherical thrust roller bearings</b>	<p>Spherical thrust roller bearings sometimes suffer from scuffing, smearing, or other defects due to sliding which occurs between the roller and raceway surface under normal operation.</p> <p>To eliminate such sliding, it is necessary to mount the bearing without clearance, and apply an axial load (preload) larger than the minimum necessary axial load determined by the following equation. (the higher value determined by the two equations should be taken)</p> $F_{a \min} = \frac{C_{0a}}{2\,000}$ $F_{a \min} = 1.8F_r + 1.33 \left( \frac{n}{1\,000} \right)^2 \cdot \left( \frac{C_{0a}}{1\,000} \right)^2 \times 10^{-4}$ <p>where :</p> <ul style="list-style-type: none"> <li><math>F_{a \min}</math> : minimum necessary axial load      N</li> <li><math>F_r</math> : radial load      N</li> <li><math>n</math> : rotational speed      min<sup>-1</sup></li> <li><math>C_{0a}</math> : static axial load rating      N</li> </ul>
<b>Standard cage</b>	Machined cage
<b>Equivalent axial load</b>	<p><b>Dynamic equivalent axial load</b> ..... <math>P_a = 1.2 F_r + F_a</math></p> <p><b>Static equivalent axial load</b> ..... <math>P_{0a} \cong 2.7 F_r + F_a</math>      (Note : <math>F_r / F_a \leq 0.55</math>)</p>



# Spherical thrust roller bearings

$d$  100 ~ (220) mm

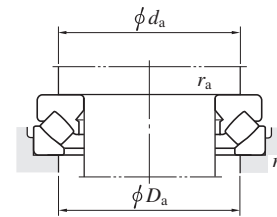
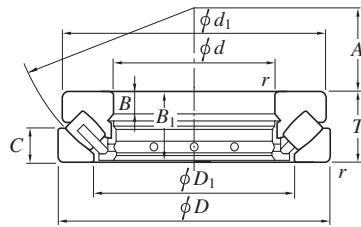

Boundary dimensions (mm)				Basic load ratings (kN)		Bearing No.	Dimensions (mm)						Mounting dimensions (mm)			(Refer.) Mass (kg)
$d$	$D$	$T$	$r_{min.}$	$C_a$	$C_{0a}$		$d_1$	$D_1$	$B$	$B_1$	$C$	$A$	$d_a$ min.	$D_a$ max.	$r_a$ max.	Mass
100	170	42	1.5	385	1 270	29320R 29420R	163	129	14	40	20.8	58	130	150	1.5	3.91
	210	67	3	730	2 220		200	146	24	64	32	62	150	175	2.5	11.2
110	190	48	2	502	1 690	29322R 29422R	182	143	16	45.5	23	64	145	165	2	5.67
	230	73	3	896	2 810		220	162	26	69	35	69	165	190	2.5	14.7
120	210	54	2.1	565	2 030	29324R 29424R	200	159	18	51	26	70	160	180	2	7.90
	250	78	4	1 040	3 270		236	174	29	74	37	74	180	205	3	18.5
130	225	58	2.1	715	2 440	29326R 29426R	215	171	19	55	28	76	170	195	2	9.45
	270	85	4	1 200	3 870		255	189	31	81	41	81	195	225	3	23.5
140	240	60	2.1	707	2 490	29328 29428R	230	183	20	57	29	82	185	205	2	11.1
	280	85	4	1 260	4 080		268	199	31	81	41	86	205	235	3	24.6
150	250	60	2.1	767	2 740	29330R 29430R	240	194	20	57	29	87	195	215	2	11.7
	300	90	4	1 380	4 620		285	214	32	86	44	92	220	250	3	29.6
160	270	67	3	862	3 070	29332 29432R	260	208	23	64	32	92	210	235	2.5	15.4
	320	95	5	1 590	5 370		306	229	34	91	45	99	230	265	4	35.9
170	280	67	3	922	3 180	29334A 29434R	270	216	23	64	32	96	220	245	2.5	15.4
	340	103	5	1 740	5 880		324	243	37	99	50	104	245	285	4	44.0
180	300	73	3	896	3 170	29336 29436R	290	232	25	69	35	103	235	260	2.5	20.7
	360	109	5	1 960	6 590		342	255	39	105	52	110	260	300	4	52.2
190	320	78	4	1 170	4 230	29338 29438R	308	246	27	74	38	110	250	275	3	25.1
	380	115	5	2 230	7 690		360	271	41	111	55	117	275	320	4	61.4
200	280	48	2	513	2 170	29240 29340 29440R	271	236	15	45	24	108	235	255	2	8.90
	340	85	4	1 360	5 040		325	261	29	81	41	116	265	295	3	31.2
	400	122	5	2 460	8 470		380	286	43	117	59	122	290	335	4	73.0
220	300	48	2	536	2 340	29244 29344	292	254	15	45	24	117	260	275	2	10.0
	360	85	4	1 380	5 240		345	280	29	81	41	125	285	315	3	33.3

$d$  (220) ~ (400) mm

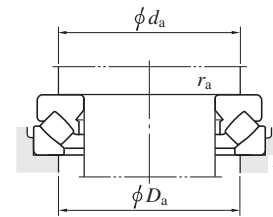
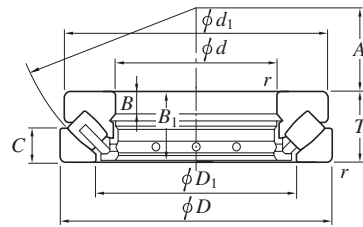

Boundary dimensions (mm)				Basic load ratings (kN)		Bearing No.	Dimensions (mm)						Mounting dimensions (mm)			(Refer.) Mass (kg)
$d$	$D$	$T$	$r_{min.}$	$C_a$	$C_{0a}$		$d_1$	$D_1$	$B$	$B_1$	$C$	$A$	$d_a$ min.	$D_a$ max.	$r_a$ max.	
220	420	122	6	2 540	8 990	<b>29444R</b>	400	308	43	117	58	132	310	355	5	74.2
240	340	60	2.1	822	3 670	<b>29248</b>	330	283	19	57	30	130	285	305	2	16.7
	380	85	4	1 430	5 330	<b>29348A</b>	365	300	29	81	41	135	300	330	3	35.5
	440	122	6	2 610	9 510	<b>29448R</b>	420	326	43	117	59	142	330	375	5	83.0
260	360	60	2.1	838	3 720	<b>29252</b>	350	302	19	57	30	139	305	325	2	18.5
	420	95	5	1 540	6 040	<b>29352</b>	405	329	32	91	45	148	330	365	4	51.5
	480	132	6	3 100	11 100	<b>29452R</b>	460	357	48	127	64	154	360	405	5	110
280	380	60	2.1	826	3 730	<b>29256</b>	370	323	19	57	30	150	325	345	2	19.5
	440	95	5	1 760	6 870	<b>29356</b>	423	348	32	91	46	158	350	390	4	53.2
	520	145	6	3 650	13 600	<b>29456R</b>	495	387	52	140	68	166	390	440	5	137
300	420	73	3	1 060	4 880	<b>29260</b>	405	353	21	69	38	162	355	380	2.5	30.5
	480	109	5	1 970	7 780	<b>29360</b>	460	379	37	105	50	168	380	420	4	74.9
	540	145	6	3 880	14 900	<b>29460R</b>	515	402	52	140	70	175	410	460	5	146
320	440	73	3	1 430	6 480	<b>29264R</b>	430	372	21	69	38	172	375	400	2.5	32.7
	500	109	5	2 310	9 380	<b>29364</b>	482	399	37	105	53	180	400	440	4	78.0
	580	155	7.5	4 160	16 100	<b>29464R</b>	555	435	55	149	75	191	435	495	6	179
340	460	73	3	1 390	6 420	<b>29268R</b>	445	395	21	69	37	183	395	420	2.5	34.7
	540	122	5	3 050	12 700	<b>29368R</b>	520	428	41	117	59	192	430	470	4	106
	620	170	7.5	4 960	19 400	<b>29468R</b>	590	462	61	164	82	201	465	530	6	224
360	500	85	4	1 310	6 080	<b>29272</b>	485	423	25	81	44	194	420	455	3	51.8
	560	122	5	3 120	13 200	<b>29372R</b>	540	448	41	117	59	202	450	495	4	110
	640	170	7.5	5 150	20 600	<b>29472R</b>	610	480	61	164	82	210	485	550	6	231
380	520	85	4	1 380	6 610	<b>29276</b>	505	441	27	81	42	202	440	475	3	52.8
	600	132	6	3 540	15 000	<b>29376R</b>	580	477	44	127	63	216	480	525	5	141
	670	175	7.5	5 420	22 000	<b>29476R</b>	640	504	63	168	85	230	510	575	6	263
400	540	85	4	1 580	7 610	<b>29280</b>	526	460	27	81	42	212	460	490	3	55.3
	620	132	6	3 700	16 100	<b>29380R</b>	596	494	44	127	64	225	500	550	5	144

# Spherical thrust roller bearings

$d$  (400) ~ 710 mm

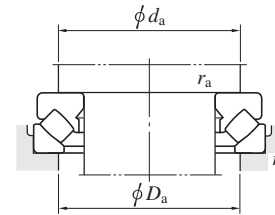
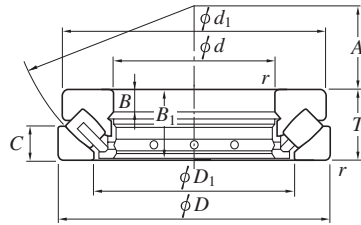

Boundary dimensions (mm)				Basic load ratings (kN)		Bearing No.	Dimensions (mm)						Mounting dimensions (mm)			(Refer.) Mass (kg)
$d$	$D$	$T$	$r_{\min.}$	$C_a$	$C_{0a}$		$d_1$	$D_1$	$B$	$B_1$	$C$	$A$	$d_a$ min.	$D_a$ max.	$r_a$ max.	
400	710	185	7.5	6 200	25 300	<b>29480R</b>	680	534	67	178	89	236	540	610	6	315
420	580	95	5	1 850	8 750	<b>29284</b>	564	489	30	91	46	225	490	525	4	75.4
	650	140	6	4 060	17 700	<b>29384R</b>	626	520	48	135	68	235	525	575	5	169
	730	185	7.5	6 380	26 500	<b>29484R</b>	700	556	67	178	89	244	560	630	6	330
440	600	95	5	1 870	8 970	<b>29288</b>	585	508	30	91	49	235	510	545	4	77.9
	680	145	6	4 290	18 800	<b>29388R</b>	655	548	49	140	70	245	550	600	5	190
	780	206	9.5	7 290	30 000	<b>29488R</b>	745	588	74	199	100	260	595	670	8	423
460	620	95	5	1 950	9 620	<b>29292</b>	605	530	30	91	46	245	530	570	4	81.0
	710	150	6	3 680	15 800	<b>29392</b>	685	567	51	144	72	257	575	630	5	216
	800	206	9.5	7 520	31 600	<b>29492R</b>	765	608	74	199	100	272	615	690	8	438
480	650	103	5	2 300	11 600	<b>29296</b>	635	556	33	99	55	259	555	595	4	89.0
	730	150	6	3 650	15 800	<b>29396</b>	705	590	51	144	72	270	595	650	5	218
	850	224	9.5	8 690	36 300	<b>29496R</b>	810	638	81	216	108	280	645	730	8	548
500	870	224	9.5	8 650	36 400	<b>294/500R</b>	830	661	81	216	107	290	670	750	8	562
530	710	109	5	2 480	12 700	<b>292/530</b>	692	610	35	105	56	287	615	650	4	122
	800	160	7.5	4 790	26 000	<b>293/530</b>	772	648	54	154	76	295	650	715	6	285
	920	236	9.5	9 450	40 000	<b>294/530R</b>	880	700	87	228	114	309	705	795	8	664
560	750	115	5	2 770	13 900	<b>292/560</b>	732	644	37	111	60	302	645	690	4	145
	850	175	7.5	5 390	29 100	<b>293/560</b>	822	690	60	168	85	310	695	760	6	355
	980	250	12	9 890	40 500	<b>294/560</b>	940	729	90	242	120	328	750	835	10	793
600	800	122	5	2 950	15 500	<b>292/600</b>	780	688	39	117	65	321	690	735	4	171
	1 030	258	12	11 200	54 400	<b>294/600</b>	990	785	92	248	127	347	790	890	10	905
630	1 090	280	12	12 200	58 300	<b>294/630</b>	1 040	830	100	270	136	365	835	940	10	1 110
710	950	145	6	4 230	22 500	<b>292/710</b>	930	815	46	140	75	380	820	870	5	290
	1 220	308	15	15 400	76 300	<b>294/710</b>	1 165	925	113	298	150	415	930	1 050	12	1 520

# Spherical thrust roller bearings

$d$  800 ~ 1 060 mm

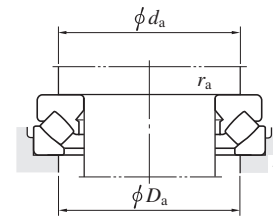
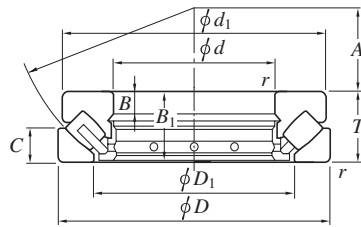

Boundary dimensions (mm)				Basic load ratings (kN)		Bearing No.	Dimensions (mm)						Mounting dimensions (mm)			(Refer.) Mass (kg)
$d$	$D$	$T$	$r_{\min.}$	$C_a$	$C_{0a}$		$d_1$	$D_1$	$B$	$B_1$	$C$	$A$	$d_a$ min.	$D_a$ max.	$r_a$ max.	
<b>800</b>	1 180	230	9.5	9 170	45 700	<b>293/800</b>	1 146	965	78	222	112	440	975	1 055	8	850
<b>1 060</b>	1 400	206	9.5	8 860	52 000	<b>292/1060</b>	1 370	1 208	66	199	108	566	1 210	1 285	8	865



# Bearings for continuous casting machines

- In continuous casting machines, roll support bearings are used under heavy loads and at extremely low speed. In addition, the operating conditions are severe, resulting in exposure to splashing water and scales.
- SCP bearings for fixed side and SC bearings for free side are used for end of rolls.
- HSC bearing units with half-round outer ring is used for the intermediate support section of beetle-shape rolls, such as driving rolls.
- JTEKT bearings for continuous casting machines are designed based on a full complement cylindrical roller bearing, with reference to maximized static load ratings. Crowning are set up on rolling surface of its rollers, according to the size of loads, which contributes to solve stress concentration at specific location.
- The bearing has the self-aligning mechanism to absorb roll bending and misalignment due to heavy load.

■ SC bearings (free side)  
(page 430)

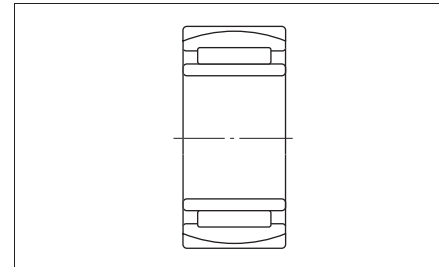

- To accommodate thermal contraction and expansion of roll, the inner ring of this bearing are designed to move smoothly in the axial direction.

■ SCP bearings (fixed side)  
(page 430)

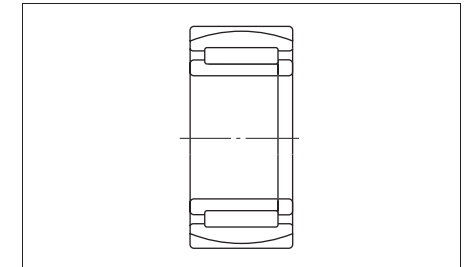

- The bearing has been developed for the purpose of improvement in short service life of spherical roller bearings most commonly used for continuous casting machines.
- The ribs provided for the inner and outer rings and loose rib allow accommodation of axial loads generated by thermal contraction and expansion of rolls.

■ HSC bearing units with half-round outer ring (page 436)

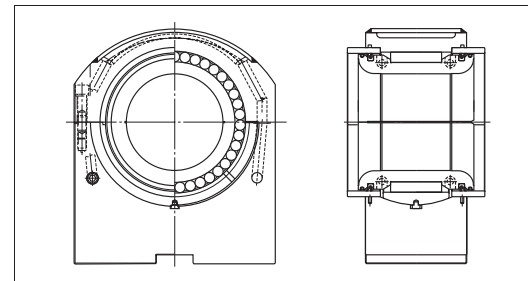

- To accommodate thermal contraction and expansion of roll, the inner ring and roller of this bearing are designed to move smoothly in the axial direction.
- This unit has unique structure, with a half-round outer ring placed on the loaded side only.
- This special half-round outer ring and compact seal design realizes a 15 % increase in static load rating over that of conventional products.
- The unique jacket design adjusts the flow of water and enables a high cooling efficiency, equivalent to that of conventional products with a lower water flow rate of 55 %.

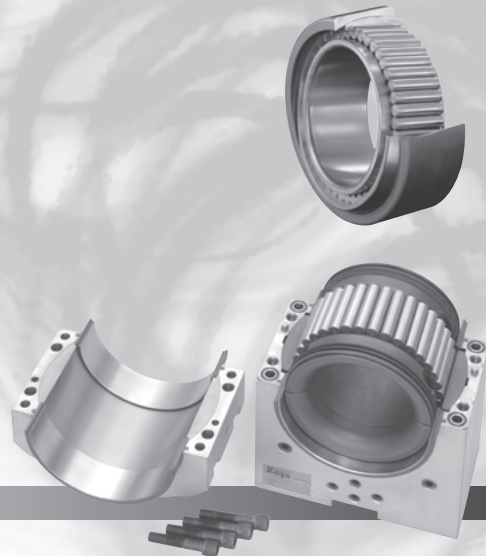

$d$  50 ~ (110) mm

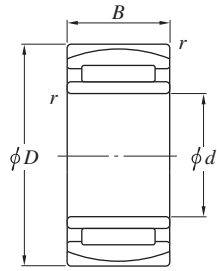

Design 1

SC bearings (free side)

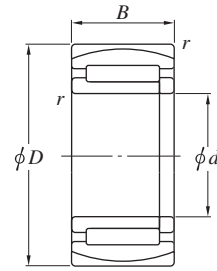

Design 2

SCP bearings (fixed side)

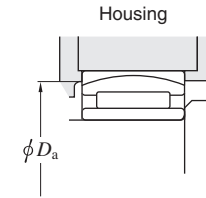

Boundary dimensions (mm)				Acceptable roll heat expansion (mm)	Basic load ratings (kN)		Bearing No.	Corresponding spherical roller bearing Bearing No.	Basic load ratings (kN)		Mass (kg)	Mounting dimensions (mm) $D_a$		Design
$d$	$D$	$B$	$r_{min.}$		$C_r$	$C_{0r}$			$C_r$	$C_{0r}$		min.	max.	
50	110	40	2	±4.5	164	254	SC101140VA	22310RHR	204	237	2.1	96	99	1
55	90	32	1.1	±3.5	89.9	202	SC119032VA	—	—	—	0.9	81	82	1
		100	25											
65	120	31	1.5	±4	118	206	SC131231V-1A	22213RHR	178	211	1.7	110	111	1
		140	48											
70	125	31	1.5	±6	126	213	SC141331VA	22214RHR	187	222	1.8	116	117	1
		150	51											
75	130	31	1.5	±5	148	237	SC151331VA	22215RHR	193	236	1.9	120	121	1
85	150	65	3	±8	280	621	SC171565VA	24217RHB	370	558	5.4	129	137	1
		150	65											
90	160	40	2	±4.5	240	427	SC181640-1VA	22218RHR	298	381	3.8	147	149	1
	160	40	2	—	194	400	SCP181640V-1A	22218RHR	298	381	3.9	147	149	2
	160	52.4	2	±5.5	309	555	SC181652VA	23218RH	336	482	4.9	144	148	1
	160	52.4	1.1	—	271	566	SCP181652V-2A	23218RH	336	482	5.1	144	148	2
	160	45/48	2	±5.5	249	507	SC181645/48V-1A	—	—	—	4.4	147	150	1
100	150	50	1.5	±6	232	543	SC201550VA	—	—	—	3.4	137	139	1
	150	50	1.5	—	232	543	SCP201550VA	—	—	—	3.4	137	139	2
	165	52	2	±5.5	279	600	SC201752V-1A	23120RH	328	510	4.8	149	153	1
105	160	56	2	±9	242	594	SC211656VA	24021RHA	317	550	4.4	144	149	1
110	170	45	2	±5.5	260	523	SC221745V-3A	23022RH	300	486	4.0	158	160	1
	170	45	2	—	260	523	SCP221745V-3A	23022RH	300	486	4.1	158	160	2
	170	60	2	±8	279	722	SC221760V-1A	24022RH	375	647	5.5	152	157	1
	170	64	2	±10	279	722	SC221764VA	—	—	—	5.8	151	157	1
	180	56	2	±7.5	296	667	SC221856V-8A	23122RH	385	605	6.1	162	167	1
	180	69	2	±9	355	842	SC221869V-3A	24122RH	469	778	7.6	157	164	1

$d$  (110) ~ (150) mm

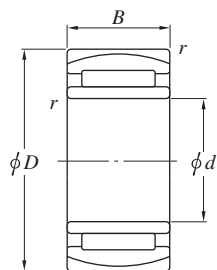

Design 1

SC bearings (free side)

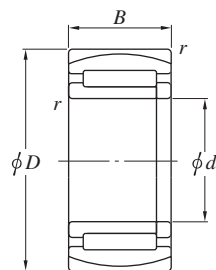

Design 2

SCP bearings (fixed side)

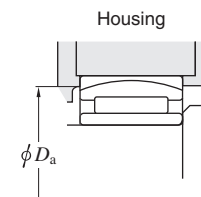

Boundary dimensions (mm)				Acceptable roll heat expansion (mm)	Basic load ratings (kN)		Bearing No.		Corresponding spherical roller bearing		Mass (kg)	Mounting dimensions (mm)		Design
$d$	$D$	$B$	$r_{min.}$		$C_r$	$C_{0r}$			Bearing No.	Basic load ratings (kN)		$D_a$	min.	
								$C_r$	$C_{0r}$					
110	180	69	2	—	355	842	SCP221869V-3A	24122RH	469	778	7.8	157	164	2
	200	53	2.1	—	333	626	SCP222053VA	22222RHR	491	642	8.2	182	187	2
120	180	46	2	$\pm 6$	231	588	SC241846V-2A	23024RH	314	524	4.5	168	170	1
	180	46	2	—	231	588	SCP241846V-2A	23024RH	314	524	4.6	168	170	2
	180	54	2	$\pm 12$	246	516	SC241854VA	—	—	—	5.0	165	169	1
	180	58	2	$\pm 8$	274	726	SC241858V-1A	—	—	—	5.7	164	168	1
	180	60	2	$\pm 9$	274	726	SC241860V-1A	24024RH	397	709	5.8	163	168	1
	180	56/46	2	$\pm 10$	279	626	SC241856/46VA	—	—	—	5.2	165	169	1
	200	80	2	$\pm 9.5$	521	1 120	SC242080VA	24124RH	605	1 020	11.1	174	183	1
200	80	2	—	431	1 040	SCP242080V-3A	24124RH	605	1 020	12.0	174	183	2	
130	200	52	2	—	295	701	SCP262052V-1A	23026RH	404	674	6.7	186	189	2
	200	69	2	$\pm 9$	381	969	SC262069V-1A	24026RH	512	914	8.7	179	186	1
	200	69	2	—	381	969	SCP262069V-1A	24026RH	512	914	8.9	179	186	2
	200	79/69	2	$\pm 11$	443	1 090	SC262079/69VA	—	—	—	9.6	177	185	1
	210	64	2	$\pm 10$	408	882	SC262164VA	23126RH	494	799	9.2	190	196	1
	210	80	2	$\pm 11.5$	448	1 120	SC262180V-2A	24126RH	620	1 080	11.9	184	193	1
	210	80	2	—	448	1 120	SCP262180V-2A	24126RH	620	1 080	12.2	184	193	2
	230	64	3	$\pm 9$	442	950	SC262364V-2A	22226RHR	658	914	12.5	209	215	1
140	210	53	2	$\pm 6$	331	834	SC282153V-1A	23028RH	422	723	7.1	195	199	1
	210	53	2	—	331	834	SCP282153V-1A	23028RH	422	723	7.2	195	199	2
	210	69	2	$\pm 9.5$	431	1 010	SC282169RVA	24028RH	524	957	8.8	191	196	1
	210	69	2	—	431	1 010	SCP282169RVA	24028RH	524	957	9.3	191	196	2
	225	68	2.1	$\pm 7$	512	1 150	SC282368RVA	23128RH	565	940	11.1	204	210	1
	225	68	2.1	—	465	1 020	SCP282368V-1A	23128RH	565	940	11.6	204	210	2
	225	85	2.1	$\pm 11.5$	521	1 300	SC282385V-1A	24128RH	702	1 220	14.4	199	208	1
	225	85	2.1	—	521	1 300	SCP282385V-1A	24128RH	702	1 220	14.8	199	208	2
150	225	75	2.1	$\pm 9$	492	1 220	SC302375V-6A	24030RH	593	1 100	11.4	203	209	1
	225	75	2.1	—	492	1 220	SCP302375V-6A	24030RH	593	1 100	11.8	203	209	2

$d$  (150) ~ 220 mm

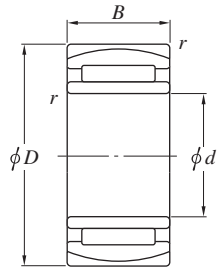

Design 1

SC bearings (free side)

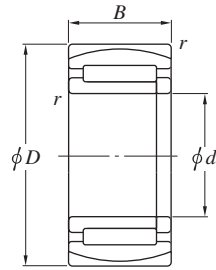

Design 2

SCP bearings (fixed side)

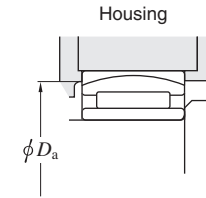

Boundary dimensions (mm)				Acceptable roll heat expansion (mm)	Basic load ratings (kN)		Bearing No.		Corresponding spherical roller bearing		Mass (kg)	Mounting dimensions (mm)		Design
$d$	$D$	$B$	$r_{min.}$		$C_r$	$C_{0r}$			Bearing No.	Basic load ratings (kN)		$D_a$	min.	
								$C_r$	$C_{0r}$					
150	250	100	2.1	±14	666	1 650	SC3025100V-1A SC302796VA	24130RH	915	1 590	21.9	218	230	1
	270	96	3	±12	806	1 670		23230RH	959	1 540	26.2	236	247	1
160	240	80	2.1	±13	542	1 280	SC322480-2VA SC3227109VA SC3234114VA	24032RH	679	1 270	13.6	216	225	1
	270	109	2.1	±13.5	867	1 980		24132RH	1 070	1 890	28.0	233	247	1
	340	114	4	±15	1 230	2 300		22332RHA	1 420	1 940	55.3	303	316	1
170	260	90	2.1	±14	622	1 560	SC342690V-1A SCP342690V-1A SC3431110VA	24034RH	828	1 540	18.7	232	241	1
	260	90	2.1	—	622	1 560		24034RH	828	1 540	19.1	232	241	2
	310	110	4	±14	1 010	2 180		23234RHA	1 210	1 940	40.1	270	285	1
180	280	100	2.1	±14	743	1 890	SC3628100V-1A SC3632112V-1A SCP3632112V-1A	24036RH	984	1 830	25.0	248	260	1
	320	112	4	±15	950	2 350		23236RHA	1 320	2 170	43.5	280	295	1
	320	112	4	—	950	2 350		23236RHA	1 320	2 170	44.1	280	295	2
190	290	75	2.1	—	595	1 530	SCP382975V-1A SC3829100V-1A SCP3829100V-1A	23038RHA	789	1 430	20.3	268	274	2
	290	100	2.1	±14	768	2 030		24038RHA	1 010	1 920	26.1	259	269	1
	290	100	2.1	—	768	2 030		24038RHA	1 010	1 920	26.8	259	269	2
	320	104	3	±12	1 030	2 270	SC3832104VA	23138RHA	1 210	2 080	37.2	288	298	1
	320	128	4	±15.5	1 120	2 790	SC3832128VA	24138RHA	1 460	2 630	46.7	278	293	1
	320	128	4	—	1 120	2 790	SCP3832128VA	24138RHA	1 460	2 630	47.8	278	293	2
	340	120	4	±16	1 110	2 720	SC3834120V-1A	23238RHA	1 490	2 470	53.0	301	315	1
200	310	82	2.1	—	692	1 810	SCP403182VA SC403111RVA SC4034112V-1A SC4034140VA	23040RHA	940	1 680	25.9	282	291	2
	310	109	2.1	±11	978	2 550		24040RHA	1 180	2 230	33.5	273	286	1
	340	112	3	±16	1 080	2 490		23140RHA	1 380	2 340	46.0	304	317	1
	340	140	3	±19	1 350	3 090		24140RHA	1 660	2 970	56.1	292	313	1
220	370	150	4	±19	1 540	3 750	SC4437150VA	24144RHA	1 920	3 550	72.3	320	340	1

D 195 ~ (260) mm

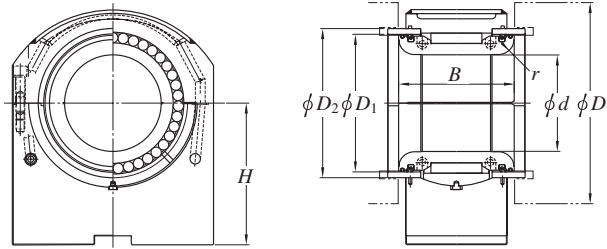

Roll outside dia. D	Boundary dimensions (mm)						Housing unit No.	Seal type		Bearing No.	Acceptable roll heat expansion (mm)	Basic load ratings (kN)	
	d	B	H	D <sub>1</sub>	D <sub>2</sub>	r		Recovery type	Non-recovery type			C <sub>r</sub>	C <sub>0r</sub>
195	100	145	175	133	143	C8	PBA391H	—	○	HSC2017-1C3	±7	373	876
220	110	139	225	155	168	18	PBA399H	○	—	HSC2219-7C3	±9	402	876
	110	139	225	155	168	18	PBA360H	○	—	HSC2219-6C3	±9	433	966
225	100	169	132	140	150	15	PBA328H	—	○	HSC2019C3	±8	603	1 250
230	110	113	185	160	173	13	PBA171H	—	○	HSC2219-3C3	±8	337	619
	110	113	185	160	173	13	PBA171H	○	—	HSC2219-8C3	±8	337	619
	110	141	246	160	173	18	PBA171AXH	—	○	HSC2219-1C3	±8	528	1 120
	110	148	351	160	173	13	PBA171AH	—	○	HSC2219C3	±8	421	846
	110	148	351	160	173	13	PBA171AH	○	—	HSC2219-9C3	±8	421	846
	110	150	190	160	173	15	PBA208H	—	○	HSC2219-2C3	±8	554	1 190
	110	150	190	160	173	15	PBA208H	○	—	HSC2219-11C3	±8	554	1 190
	110	154	180	160	173	20	PBA368H	—	○	HSC2219-4C3	±8	554	1 190
110	154	180	160	173	20	PBA404H	○	—	HSC2220C3	±9	575	1 270	
235	140	145	175	175	186.5	C8	PBA339H	—	○	HSC2821C3	±5	431	1 160
240	115	202	251	160	175	15	PBA316H	—	○	HSC2321C3	±10	745	1 550
	115	202	251	160	175	15	PBA316H	○	—	HSC2321-2C3	±10	745	1 550
	120	173	230	165	180	15	PBA396H	○	—	HSC2421-2C3	±9	673	1 510
250	120	151	190	172	185	20	PBA411H	○	—	HSC2421-6C3	±9	576	1 310
	120	153	185	175	190	20	PBA336H	—	○	HSC2421C3	±8	651	1 380
	120	153	145	175	190	20	PBA336AH	—	○	HSC2421C3	±8	651	1 380
	120	154	175	170	188	20	PBA378H	○	—	HSC2421-1C3	±10	578	1 190
	120	154	190	175	190	20	PBA251H-2	○	—	HSC2421-4C3	±9	605	1 400
	120	154	180	175	190	20	PBA251H	—	○	HSC2421-3C3	±9	605	1 400
	120	154	180	170	185	20	PBA407H	○	—	HSC2421-5C3	±9	605	1 400
255	125	174	180	180	195	20	PBA410H	○	—	HSC2522C3	±9	793	1 740
260	120	154	180	170	188	20	PBA379H	○	—	HSC2421-1C3	±10	578	1 190

D (260) ~ 320 mm

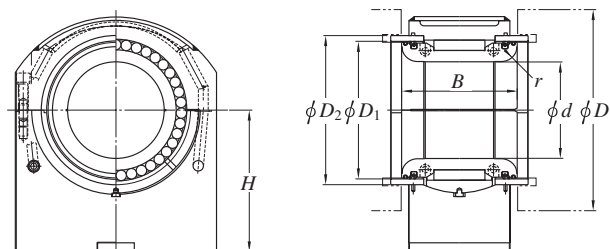

Roll outside dia. <i>D</i>	Boundary dimensions (mm)						Housing unit No.		Seal type		Bearing No.	Acceptable roll heat expansion (mm)	Basic load ratings (kN)	
	<i>d</i>	<i>B</i>	<i>H</i>	<i>D</i> <sub>1</sub>	<i>D</i> <sub>2</sub>	<i>r</i>			Recovery type	Non-recovery type			<i>C</i> <sub>r</sub>	<i>C</i> <sub>0r</sub>
260	130	157	180	185	200	20	PBA412H	○	—	HSC2622-2C3	±9	623	1 480	
265	140	175	242.5	190	205	20	PBA397H	○	—	HSC2823-2C3	±9	699	1 640	
	140	191	250	190	205	20	PBA355H	—	○	HSC2823-1C3	±7	721	1 710	
270	130	154	190	185	200	20	PBA252H	—	○	HSC2622C3	±9	623	1 480	
	140	126	205	199	212	16	PBA176H	—	○	HSC2823C3	±8	505	992	
	140	126	205	199	212	16	PBA176H	○	—	HSC2823-3C3	±8	505	992	
	140	174	205	199	212	20	PBA207H	—	○	HSC2824-1C3	±8	863	1 980	
	140	174	205	199	212	20	PBA207H	○	—	HSC2824-4C3	±8	863	1 980	
275	150	163	175	190	203.5	C10	PBA389H	—	○	HSC3024C3	±7	711	1 800	
280	130	174	205	185	200	20	PBA337H	—	○	HSC2624C3	±8	846	1 910	
	130	174	160	185	200	20	PBA337AH	—	○	HSC2624C3	±8	846	1 910	
	145	196	260	200	215	20	PBA356H	—	○	HSC2925-1C3	±6	840	1 930	
290	140	139	215	208	223	16	PBA177H	—	○	HSC2825C3	±8	863	1 980	
	140	139	215	208	223	16	PBA177H	○	—	HSC2825-1C3	±8	863	1 980	
	145	178	215	208	223	20	PBA206H	—	○	HSC2925C3	±8	967	2 260	
	145	178	215	208	223	20	PBA206H	○	—	HSC2925-2C3	±8	967	2 260	
295	145	208	270	200	215	20	PBA357H	—	○	HSC2926C3	±6	880	2 260	
305	150	169	205	205	220	20	PBA408H	○	—	HSC3025C3	±8.5	855	1 990	
310	140	184	215	205	220	20	PBA338H	—	○	HSC2827C3	±8	1 000	2 210	
	140	184	175	205	220	20	PBA338AH	—	○	HSC2827C3	±8	1 000	2 210	
320	150	187	220	220	235	20	PBA380H	—	○	HSC3028C3	±9	1 040	2 370	
	160	150	291	240	255	18	PBA178H	—	○	HSC3228C3	±8	816	1 680	
	160	150	291	240	255	18	PBA178H	○	—	HSC3228-2C3	±8	816	1 680	
	160	199	270	215	230	20	PBA398H	○	—	HSC3227C3	±9	1 000	2 410	
	165	228	280	230	245	25	PBA358H	—	○	HSC3328C3	±6	1 030	2 550	

$D$  340 ~ 370 mm

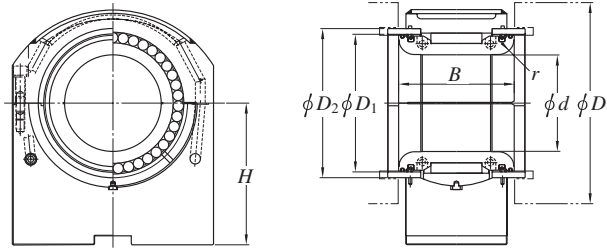

Roll outside dia. $D$	Boundary dimensions (mm)						Housing unit No.	Seal type		Bearing No.	Acceptable roll heat expansion (mm)	Basic load ratings (kN)	
	$d$	$B$	$H$	$D_1$	$D_2$	$r$		Recovery type	Non-recovery type			$C_r$	$C_{0r}$
340	180	235	280	245	260	25	PBA359H	—	○	HSC3630C3	±6	1 140	2 720
370	190	233	280	326	336	20	PBA324H	—	○	HSC3834C3	±7	1 540	3 540

# Cylindrical roller bearings for the backing shafts of multi-roll mills

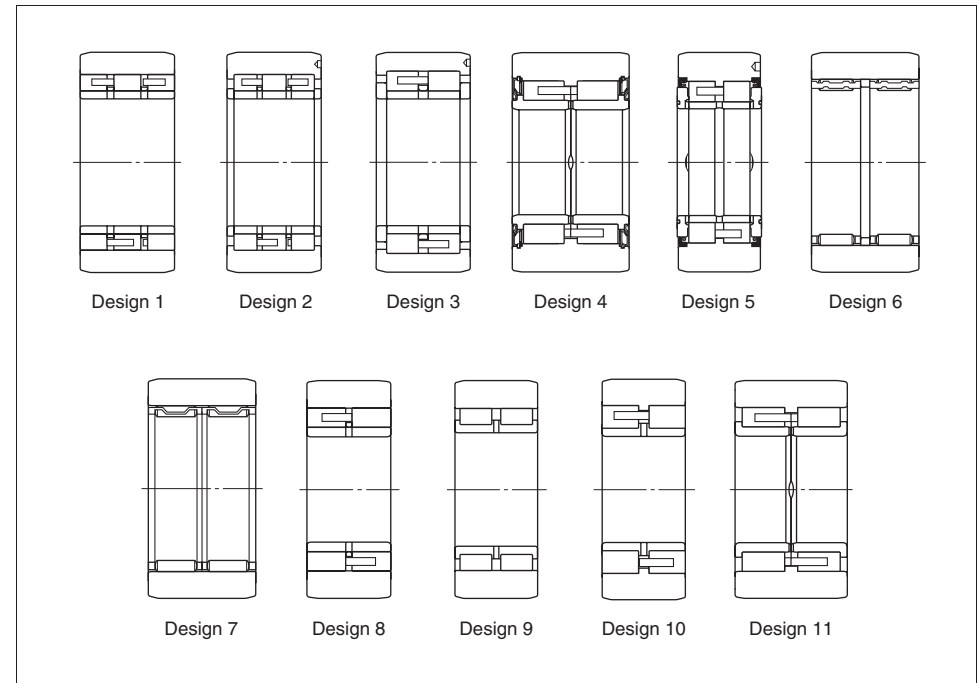

- Since the bearing is used as the back up roll in multi-roll mills, the outer ring is designed thicker than ordinary bearings.
- Since high accuracy is required for these bearings under high pressure, they are designed to have high load rating and accuracy.
- Since several bearings are mounted on a shaft, radial runout of outer ring and variations of bearing section height per unit after assembly are minimized.
- Even if the outside surface of bearing's outer ring gets rough due to foreign matters caught in, the bearing can be used again by grinding.
- Bearings installed on the backing shaft come in cylindrical roller bearing and long cylindrical roller bearing. Either of both type bearings is used appropriately depending on the characteristics of rolling mills. Above all, the cylindrical roller bearing is most commonly used.
- **These bearings are commonly used for the backing shafts of multi-roll mills.**

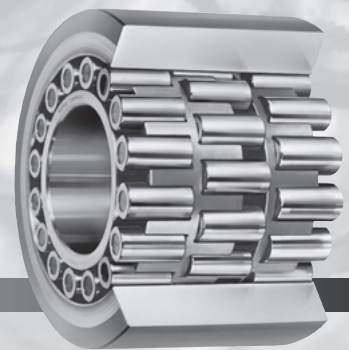



# Cylindrical roller bearings for the backing shafts of multi-roll mills

$d$  31.75 ~ (130) mm,  $F_w$  18 ~ 45 mm

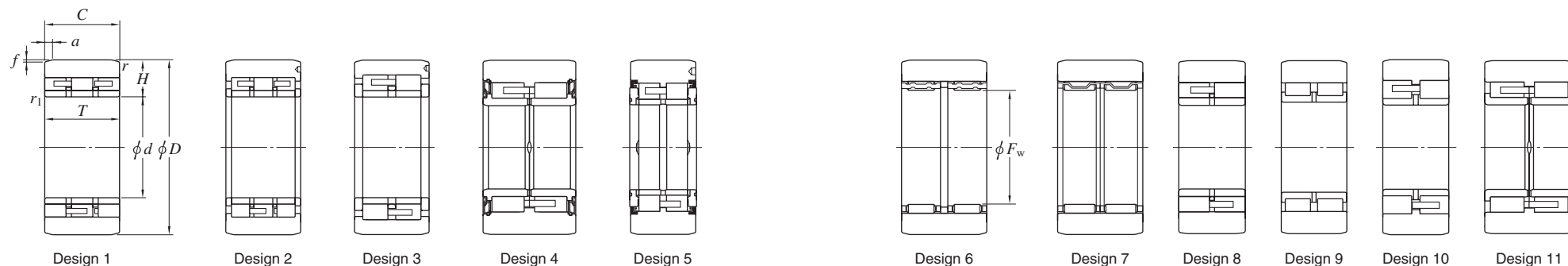

$d, (F_w)$	Boundary dimensions (mm)					Basic load ratings (kN)		Bearing No.	De-sign	Bearing section height at the time of manufacture (mm) $H$	Mass (kg)	Compatible rolling mill model	Number of bearings used
	$D$	$T$	$C$	$r$	$r_1$	$C_r$	$C_{0r}$						
(18)	35	—	46	0.5	—	33.8	52.0	04DC04046ADS	6	8.4875	0.225	Z-HIGH MILL	24
(25)	45	—	45	0.8	—	35.3	59.3	05DC05045ADS	6	9.9875	0.35	Z-HIGH MILL	64, 48
(28)	54	—	55	0.8	—	44.5	93.3	06DC05055DS	7	12.9875	0.677	Z-HIGH MILL	64
31.75	76.2	46.23	45.85	0.8	1.5	96.3	183	06DC0846A	9	22.200	1.27	ZR34	40
(45)	85	—	55	0.8	—	59.1	160	09DC09055DS	7	19.9925	1.69	Z-HIGH MILL	128
50	120	80	80	1.5	1.5	268	379	10DC1280DS	3	34.976	5.15	12-ROLL MILL	32
55	120	52.197	52	1.6	1.6	203	341	11DC1252	9	32.483	3.27	ZR24	40
65	165	70	70	1.5	2	424	586	13DC1770DS	10	49.982	8.83	20-ROLL MILL	40
70	160	90	90	1.5	1.5	347	546	14DC1690LDS-1	11	44.977	10.1	ZR33	40
	160.07	90	90	1.5	1.5	379	667	14DC1690ADS	1	45.000	10.5	ZR33	32, 48
90	220	94	94	2	1.5	687	997	18DC2294DS	10	64.976	21.2	20-ROLL MILL	40
	220	96	94	3	3	494	700	18DC2294/96DS	5	65.000	21.0	20-ROLL MILL	64
	220	95	95	2	2	532	795	18DC2295DS	3	64.982	20.9	20-ROLL MILL	40
	220	130	130	2	2	699	1 130	18DC22130ADS	2	64.982	28.7	20-ROLL MILL	40, 32
99.995	225	120	120	3	3	625	995	20DC23120KDS-2	4	62.474	26.0	ZR23	32, 40, 48
100	225	100	100	3	1.5	547	838	20DC23100NDS-1	11	62.480	21.7	ZR23	40
	225.021	80	80	1.5	1.5	607	991	20DC23080DS	8	62.474	18.2	ZR23	12
	225.021	120	120	1.5	1.5	814	1 440	20DC23120MDS	1	62.474	27.2	ZR23	32
115	260	140	140	3	2	976	1 690	23DC26140DS	2	72.470	41.9	20-ROLL MILL	40
130	300.02	130	129	2	3	1 050	1 740	26DC30130DS	3	85.010	52.2	20-ROLL MILL	56
	300.02	130	129	4	3.5	1 070	1 620	26DC30130BDS	5	85.010	51.8	20-ROLL MILL	80
	300.02	132	129	2	3	1 140	1 830	26DC30132ADS	3	85.010	53.8	20-ROLL MILL	72
	300	160	159.5	4	3.5	1 330	2 340	26DC30160DS	1	84.9617	64.8	ZR22	40, 48

*d* (130) ~ 180 mm

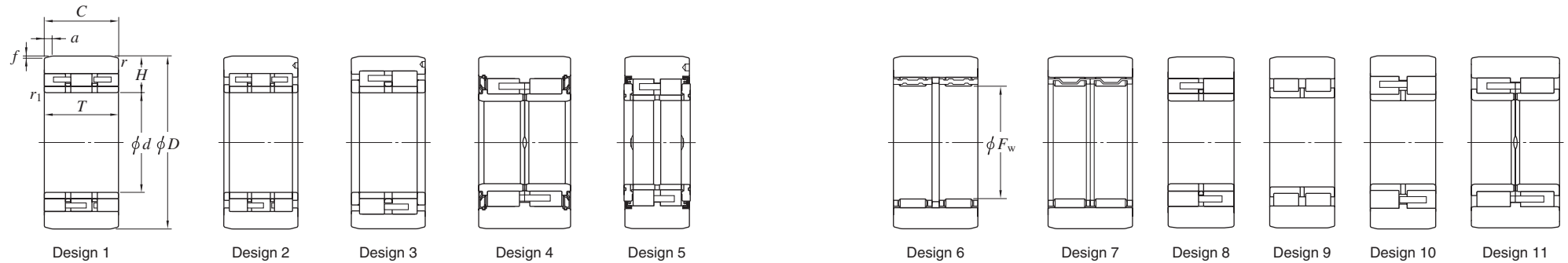

Boundary dimensions (mm)						Basic load ratings (kN)		Bearing No.	De- sign	Bearing section height at the time of manufacture (mm) <i>H</i>	Mass (kg)	Compatible rolling mill model	Number of bearings used
<i>d</i> , ( <i>F<sub>w</sub></i> )	<i>D</i>	<i>T</i>	<i>C</i>	<i>r</i>	<i>r</i> <sub>1</sub>	<i>C<sub>r</sub></i>	<i>C</i> <sub>0r</sub>						
<b>130</b>	300	172.644	172.644	4	3.5	1 560	2 900	<b>26DC30170MDS-5</b>	1	84.955	72.6	ZR22	40, 48
	300	172.644	172.644	4	3.5	1 320	2 210	<b>26DC30170KDS-3</b>	4	84.955	70.0	ZR22	40, 48
<b>179.984</b>	406.430	224.250	220	4	3	1 870	3 340	<b>36DC41224KDS</b>	4	113.181	150	ZR21	32, 48
<b>180</b>	406.420	171.04	171.04	4	4	2 060	3 810	<b>36DC41171DS</b>	1	113.155	130	ZR21	48, 56
	406.42	171.04	171.04	4	3	1 550	2 700	<b>36DC41171KDS</b>	4	113.155	121	ZR21	48
	406.420	223.96	217	4	0.5	2 350	4 500	<b>36DC41217DS+DP</b>	1	113.155	161	ZR21	40, 48
	406.42	224.25	224	4	3	2 290	4 230	<b>36DC41224QDS</b>	11	113.155	162	ZR21	40, 48

# Slewing rim bearings for tunnel-boring machine

- These bearings are designed to support the main cutters of tunnel-boring machines.

## ■ DTR...T (triple-row combined roller type) (page 450)

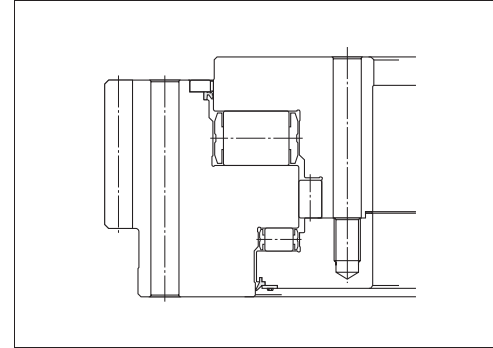

The DTR...T slewing rim bearing is a triple-row combined cylindrical roller bearing. This bearing is provided with various features required to support the main cutters of tunnel-boring machines, including superior impact resistance, high load ratings, and excellent sealing performance. When used with forced oil circulation, this bearing is provided with oil supply and oil drain ports.

As the sealing mechanism of this bearing, a labyrinth, dust seal, or pressure-resistant seal featuring high sealing performance (resistant to a static pressure of 0.3 MPa) can be selected, depending on the lubrication method used.

For convenience of transportation, DTR...T bearings with the bearing rings split cylindrically into two or four parts are also available (SP/DTR...T).

## ■ 2TR... (double-row tapered roller type) (page 458)

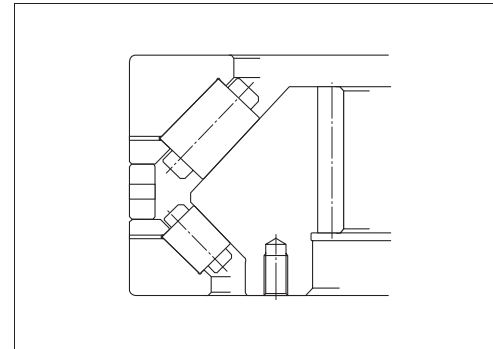

The 2TR... slewing rim bearing is a double-row tapered roller bearing. To ensure high axial load ratings, this bearing features a large contact angle. Large-sized rollers are provided on the axial load-accommodating side.

The bearing ring on the non-gear side is made from bearing steel. It is treated through normal hardening, so therefore does not have any "soft zone," which an induction-hardened bearing may have, thus eliminating limits in determining the location of the non-gear-side bearing ring on machines or equipment.

The 2TR... bearing was developed to support the main cutters (oil bath lubrication) of tunnel-boring machines.

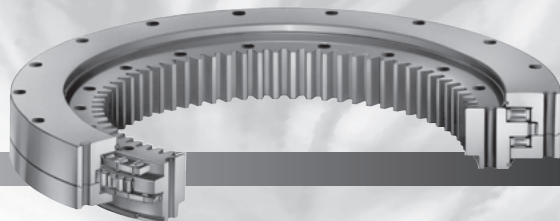

# Slewing rim bearings for tunnel-boring machine

## DTR...T type (With internal gear)

$D_a$  2 550 ~ 5 200 mm

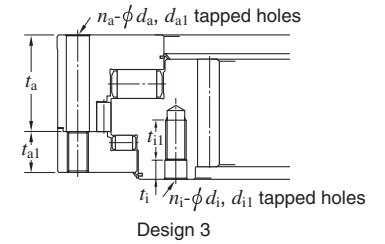
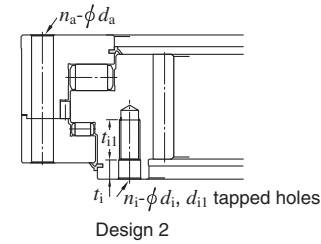
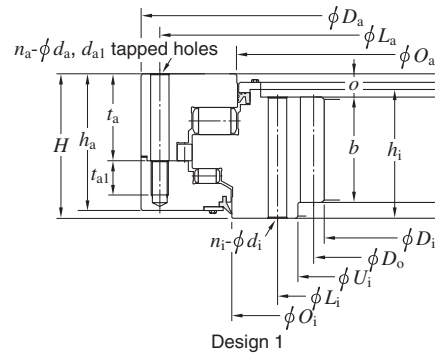

Bearing No.	De-sign	Outside dia. $D_a$	Bore dia. $D_i$	Height $H$	Gear data (pressure angle 20°)			Dimensions							Mounting-hole of outer ring					Mounting-hole of inner ring					Roller PCD	Basic static axial load rating $C_{0a}$ (kN)	Gear specifications		(Refer.) Mass (kg)		
					$D_o$	Module	No. of tooth	$b$	$h_a$	$h_i$	$o$	$O_a$	$O_i$	$U_i$	Qty.	$L_a$	$n_a$	$d_a$	$t_a$	$d_{a1}$	$t_{a1}$	Qty.	$L_i$	$n_i$			$d_i$	$t_i$		$d_{i1}$	$t_{i1}$
DTR2096TBGS	1 <sup>1)</sup>	2 550	2 096	240	2 128	16	133	190	175	210	30	2 298	2 324	2 180	2 500	48	φ24	110	M22	45	2 230	48	φ24	—	—	—	2 357	20 900	—	○	2 150
DTR2156TBGS-1	1 <sup>2)</sup>	2 595	2 156	240	2 184	14	156	190	175	210	30	2 384	2 383	2 230	2 545	48	φ24	120	M22	40	2 285	48	φ24	—	—	—	2 428	19 000	—	○	2 140
DTR2176TBGS	1 <sup>1)</sup>	2 630	2 176	240	2 208	16	138	190	175	210	30	2 378	2 404	2 260	2 580	48	φ24	110	M22	45	2 310	48	φ24	—	—	—	2 437	21 400	—	○	2 200
DTR2160TBGS	1	2 660	2 160	220	2 192	16	137	160	195	190	30	2 420	2 425	2 240	2 600	60	φ26	123	M24	50	2 300	60	φ26	—	—	—	2 474	20 200	—	○	2 480
DTR2240TBGS	1 <sup>1)</sup>	2 705	2 240	240	2 272	16	142	190	175	210	30	2 451	2 477	2 325	2 655	60	φ24	110	M22	45	2 380	60	φ24	—	—	—	2 510	22 300	—	○	2 360
DTR2296ATBGS-1	1 <sup>2)</sup>	2 735	2 296	200	2 324	16	142	190	175	210	30	2 451	2 477	2 325	2 655	60	φ24	110	M22	45	2 380	60	φ24	—	—	—	2 550	29 500	—	○	2 360
DTR2208TBG	1	2 855	2 208	275	2 240	16	140	150	265	240	35	2 512	2 575	2 295	2 790	48	φ33	175	M30	50	2 350	48	φ33	—	—	—	2 595	35 000	—	○	4 470
DTR2674TBGS	2	3 025	2 674	245	2 702	14	193	160	230	215	30	2 855	2 920	2 750	3 140	48	φ33	—	—	—	2 810	48	φ33	30	M30	60	2 940	39 500	—	○	3 790
DTR2816TBGS	1	3 460	2 816	260	2 848	16	178	160	245	230	30	3 125	3 180	2 900	3 400	60	φ30	155	M27	50	2 960	72	φ30	—	—	—	3 210	43 500	—	○	5 240
DTR2960TBGS-1	1	3 645	2 960	300	3 000	20	150	225	270	265	35	3 300	3 320	3 065	3 570	48	φ39	165	M36	60	3 140	60	φ39	—	—	—	3 375	50 300	—	○	6 570
DTR3080TBGS	3	3 750	3 080	295	3 120	20	156	220	280	245	50	3 310	3 415	3 180	3 660	72	φ45	197	M42	83	3 260	72	—	—	M42	85	3 419	63 500	—	○	6 540
DTR3240ATBGS-1	1	3 925	3 240	300	3 280	20	164	225	270	265	35	3 580	3 600	3 345	3 850	48	φ39	165	M36	60	3 420	60	φ39	—	—	—	3 655	53 000	—	○	7 120
DTR3250TBGS	1	3 925	3 250	300	3 280	20	164	225	270	265	35	3 570	3 610	3 355	3 850	48	φ39	165	M36	60	3 430	60	φ39	—	—	—	3 655	53 000	0.25	○	6 970
DTR3834BTBGS	3	4 480	3 834	305	3 870	18	215	200	280	275	30	4 050	4 155	3 925	4 400	60	φ39	197	M36×3	83	4 000	60	φ39	40	M36×3	80	4 159	78 600	—	○	8 120
DTR3996TBGS-1	3	4 700	3 996	348	4 032	18	224	210	328	296	52	4 215	4 330	4 085	4 615	88	φ39	225	M36	103	4 175	88	φ39	50	M36	75	4 335	92 100	—	○	10 500
DTR4176ATBGS	1	5 200	4 176	380	4 224	24	176	290	345	340	40	4 560	4 755	4 300	5 080	100	φ48	230	M45	75	4 395	100	φ48	—	—	—	4 733	159 000	—	○	6 970

[Notes] 1) Without oil seals.  
2) With seal upper sideonly.

# Slewing rim bearings for tunnel-boring machine

## DTR...T type (With external gear)

$D_a$  2 688 ~ 4 550 mm

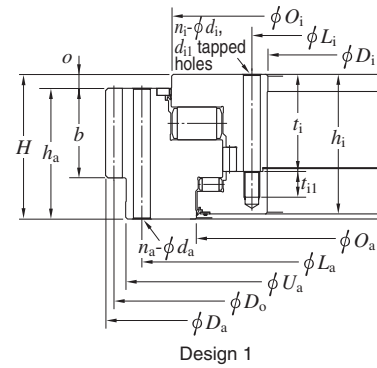

Design 1

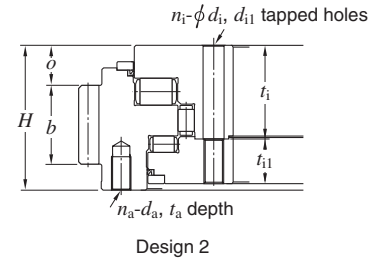

Design 2

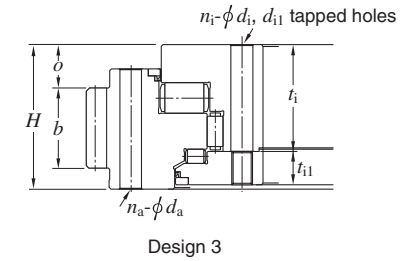

Design 3

Bearing No.	De- sign	Outside dia. $D_a$	Bore dia. $D_i$	Height $H$	Gear data (pressure angle 20°)			Dimensions							Mounting-hole of outer ring				Mounting-hole of inner ring					Roller PCD	Basic static axial load rating $C_{0a}$ (kN)	Gear specifications		(Refer.) Mass (kg)	
					$D_o$	Module	No. of tooth	$b$	$h_a$	$h_i$	$o$	$O_a$	$O_i$	$U_a$	Qty. $L_a$	$n_a$	$d_a$	$t_a$	Qty. $L_i$	$n_i$	$d_i$	$t_i$	$d_{i1}$			$t_{i1}$	Addendum modification coefficient		Induction hardened tooth flanks and bottoms
DTR2060TAGS	1	2 688	2 060	260	2 656	16	166	160	230	245	30	2 340	2 395	2 610	2 550	60	φ30	—	2 120	60	φ30	155	M27	50	2 310	31 100	—	○	3 780
DTR2150TAGS	1	2 830	2 150	300	2 800	20	140	180	240	285	60	2 480	2 540	2 730	2 650	48	φ39	—	2 235	48	φ39	178	M36	70	2 445	39 500	0.25	○	4 670
DTR2045TAGS	1	2 880	2 045	310	2 840	20	142	225	275	300	35	2 375	2 567	2 774	2 700	44	φ42	—	2 125	40	φ42	195	M39	70	2 420	79 700	—	○	6 320
DTR2020ATAG	1	2 950	2 020	400	2 900	25	116	270	355	375	45	2 420	2 550	2 825	2 720	64	φ48	—	2 120	48	φ48	265	M45	70	2 430	53 100	—	○	8 700
DTR2350TAGS-1	1	3 030	2 350	295	3 000	20	150	180	235	280	60	2 649	2 745	2 930	2 860	48	φ39	—	2 425	48	φ39	197	M36	83	2 645	47 700	0.25	○	4 980
DTR2510CTAGS	1	3 256	2 510	335	3 212	22	146	225	295	310	40	2 860	2 902	3 134	3 060	52	φ48	—	2 590	42	φ48	197	M45	70	2 820	50 700	—	○	6 660
DTR2475TAGS-1	1	3 275	2 475	355	3 225	25	129	270	315	345	40	2 850	2 905	3 134	3 060	52	φ48	—	2 555	42	φ48	225	M45	70	2 813	56 700	—	○	7 800
DTR2475TAGS-2	1	3 328	2 475	380	3 264	32	102	295	340	345	40	2 850	2 905	3 134	3 060	52	φ48	—	2 555	42	φ48	225	M45	70	2 813	56 700	—	○	8 570
DTR2735TAGS	1	3 490	2 735	350	3 460	20	173	190	290	335	60	3 087	3 185	3 390	3 315	64	φ39	—	2 810	64	φ39	215	M36	70	3 062	62 600	0.25	○	7 700
DTR2760TAGS-1	1	3 636	2 760	415	3 600	24	150	240	335	400	80	3 150	3 305	3 515	3 440	80	φ39	—	2 845	80	φ39	282	M36	75	3 155	81 500	0.25	○	10 900
DTR2870TAGS-8	1	3 696	2 870	365	3 648	24	152	290	325	350	40	3 240	3 305	3 534	3 460	72	φ48	—	2 960	60	φ48	248	M45	65	3 205	66 100	—	○	9 390
DTR2990TAG-1	2	3 740	2 990	350	3 696	22	168	190	295	335	60	3 410	3 470	3 630	3 535	48	M48	80	3 085	48	φ52	228	M48	107	3 365	60 500	—	○	8 380
DTR3460TAGS	1 <sup>1)</sup>	3 984	3 460	245	3 920	14	280	190	215	245	30	3 722	3 735	3 865	3 815	48	φ33	—	3 515	48	φ33	140	M30	50	3 663	40 600	—	○	4 350
DTR3400TAGS	1	4 250	3 400	365	4 200	25	168	290	325	350	40	3 770	3 873	4 120	4 030	100	φ48	—	3 490	80	φ48	248	M45	65	3 745	84 600	—	○	11 300
DTR3330TAGS-3	1	4 268	3 330	435	4 224	22	192	290	395	415	40	3 810	3 893	4 140	4 050	100	φ48	—	3 420	80	φ48	287	M45	85	3 745	99 600	—	○	14 800
DTR3205TAGS-1	1	4 464	3 205	550	4 416	24	184	400	500	480	50	3 650	4 042	4 340	4 230	100	φ62	—	3 295	80	φ48	320	M45	85	3 755	200 000	—	○	25 600
DTR3450TAG	1	4 500	3 450	540	4 450	25	178	250	460	520	80	3 990	4 083	4 350	4 265	108	φ48	—	3 540	91	φ48	360	M45×3 110	110	3 905	128 000	—	○	21 000
DTR3600TAGS-1	1	4 550	3 600	435	4 500	25	180	300	390	415	45	4 080	4 163	4 410	4 320	100	φ48	—	3 690	80	φ48	287	M45	85	4 015	107 000	—	○	16 100

[Note] 1) Without oil seals.

# Slewing rim bearings for tunnel-boring machine

## DTR...T type (With external gear)

$D_a$  4 851 ~ 7 200 mm

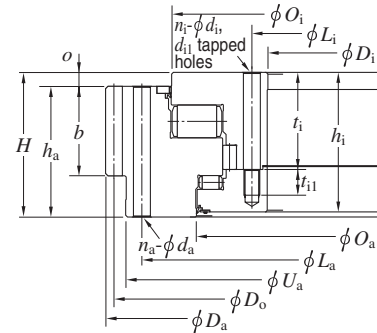

Design 1

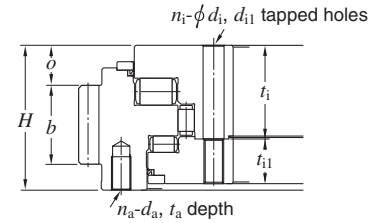

Design 2

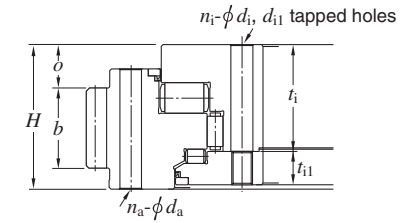

Design 3

Bearing No.	De- sign	Outside dia. $D_a$	Bore dia. $D_i$	Height $H$	Gear data (pressure angle 20°)			Dimensions							Mounting-hole of outer ring				Mounting-hole of inner ring						Roller PCD	Basic static axial load rating $C_{0a}$ (kN)	Gear specifications		(Refer.) Mass (kg)
					$D_o$	Module	No. of tooth	$b$	$h_a$	$h_i$	$o$	$O_a$	$O_i$	$U_a$	Qty. $L_a$	Qty. $n_a$	$d_a$	$t_a$	Qty. $L_i$	Qty. $n_i$	$d_i$	$t_i$	$d_{i1}$	$t_{i1}$			Addendum modification coefficient	Induction hardened tooth flanks and bottoms	
DTR3915TAGS	1	4 851	3 915	420	4 818	22	219	260	350	405	70	4 327	4 480	4 735	4 640	120	$\phi 45$	—	4 010	96	$\phi 48$	282	M45	75	4 330	113 000	0.25	○	16 500
DTR4075TAGS	1	4 851	4 075	365	4 818	22	219	260	295	345	70	4 440	4 538	4 740	4 650	96	$\phi 45$	—	4 160	96	$\phi 45$	225	M42	80	4 415	92 100	0.25	○	11 800
DTR4210TAG-2	3	5 202.4	4 210	400	5 152	28	184	224	335	390	119	4 710	4 780	5 070	4 950	60	$\phi 60$	—	4 330	72	$\phi 60$	297	M56	93	4 652	114 000	—	○	17 500
DTR4555ATAGS	1	5 500	4 555	420	5 456	22	248	260	380	405	40	4 975	5 117	5 385	5 290	120	$\phi 48$	—	4 650	96	$\phi 48$	282	M45	75	4 970	131 000	—	○	19 400
DTR4600TAG	1	5 544	4 600	420	5 500	22	250	260	380	405	40	5 075	5 160	5 430	5 335	96	$\phi 48$	—	4 695	96	$\phi 48$	282	M45	75	5 020	123 000	—	○	19 700
DTR4510TAG-1	1	5 550	4 510	440	5 500	25	220	320	390	430	50	5 035	5 140	5 420	5 310	100	$\phi 60$	—	4 620	100	$\phi 60$	300	M56	85	4 993	135 000	—	○	22 200
DTR5850TAG	1	7 200	5 850	535	7 140	30	238	300	455	515	80	6 415	6 713	7 045	6 930	120	$\phi 62$	—	5 960	120	$\phi 62$	375	M56	85	6 475	345 000	—	○	46 000

# Slewing rim bearings for tunnel-boring machine

## SP/DTR...T type (Splitted race and with external gear)

$D_a$  2 950 ~ 7 140 mm

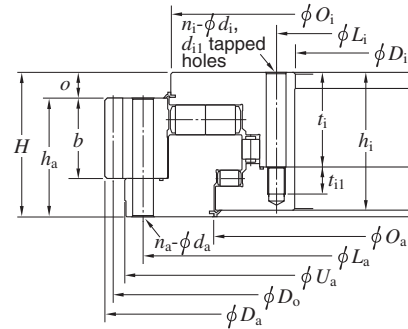

Design 1 (quarter split type)

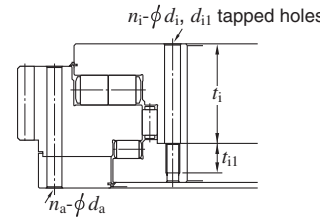

Design 2 (double split type)

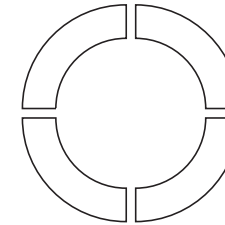

quarter split type

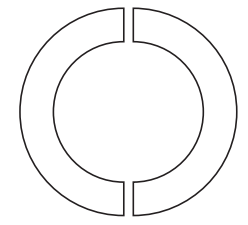

double split type

Bearing No.	De-sign	Outside dia. $D_a$	Bore dia. $D_i$	Height $H$	Gear data (pressure angle 20°)			Dimensions							Mounting-hole of outer ring			Mounting-hole of inner ring					Roller PCD	Basic static axial load rating $C_{0a}$ (kN)	Gear specifications Induction hardened tooth flanks and bottoms	(Refer.) Mass (kg)	
					$D_o$	Module	No. of tooth	$b$	$h_a$	$h_i$	$o$	$O_a$	$O_i$	$U_a$	Qty. $L_a$	Qty. $n_a$	$d_a$	Qty. $L_i$	Qty. $n_i$	$d_i$	$t_i$	$d_{i1}$					$t_{i1}$
SP/DTR2020ATAG	1	2 950	2 020	400	2 900	25	116	270	355	375	45	2 420	2 550	2 825	2 720	64	φ50	2 120	48	φ50	265	M45	70	2 430	47 200	○	8 700
SP/DTR4430TAG	1	5 550	4 430	410	5 500	25	220	250	360	390	50	4 925	5 140	5 420	5 310	80	φ62	4 550	80	φ62	280	M56	110	4 955	159 000	○	22 300
SP/DTR4860TAG	1	6 050	4 860	450	6 000	25	240	250	370	430	80	5 370	5 640	5 920	5 810	80	φ62	4 980	80	φ62	295	M56	85	5 420	222 000	○	28 000
SP/DTR5060TAG	1	6 250	5 060	450	6 200	25	248	250	370	430	80	5 570	5 840	6 120	6 010	80	φ62	5 180	80	φ62	295	M56	85	5 620	232 000	○	29 100
SP/DTR5060TAG-2	1	6 250	5 060	450	6 200	25	248	285	405	430	45	5 570	5 840	6 120	6 010	80	φ62	5 180	72	φ62	300	M56	85	5 620	232 000	○	30 000
SP/DTR5060TAG-1	1	6 300	5 060	450	6 240	30	208	250	370	430	80	5 570	5 840	6 120	6 010	96	φ62	5 180	72	φ62	300	M56	85	5 620	232 000	○	29 700
SP/DTR5790TAG	1	7 140	5 790	535	7 080	30	236	300	455	515	80	6 340	6 685	6 985	6 870	120	φ62	5 900	96	φ62	235	M56	85	6 415	319 000	○	45 600

## 2TR...type (with internal gear)

$D_a$  2 580 ~ 3 800 mm

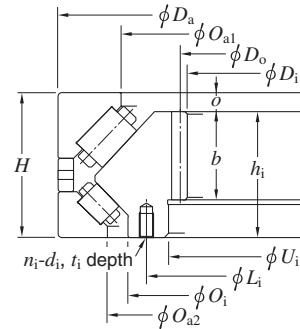

Design 1

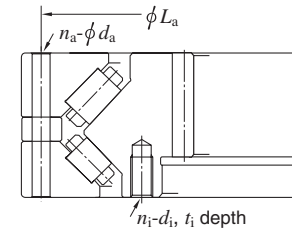

Design 2

Bearing No.	De-sign	Outside dia. $D_a$	Bore dia. $D_i$	Outer ring width $H$	Gear data (pressure angle 20°)			Dimensions							Mounting-hole of outer ring			Mounting-hole of inner ring				Basic static axial load rating $C_{0a}$ (kN)	Gear specifications Induction hardened tooth flanks and bottoms	(Refer.) Mass (kg)
					$D_o$	Module	No. of tooth	$b$	$h_i$	$o$	$O_{a1}$	$O_{a2}$	$O_i$	$U_i$	$L_a$	Qty. $n_a$	$d_a$	$L_i$	Qty. $n_i$	$d_i$	$t_i$			
2TR2048-1CS	1	2 580	2 048	320	2 080	16	130	160	260	60	2 320	2 385	2 310	2 140	—	—	—	2 230	48	M30×3	50	13 600	○	3 530
2TR2376CS	2	2 800	2 376	180	2 400	12	200	130	180	—	2 582	2 605	2 550	2 450	2 750	84	$\phi 23.5$	2 500	84	M27	50	7 200	○	1 920
2TR2448-1CS	1	2 980	2 448	330	2 480	16	155	160	265	65	2 710	2 770	2 700	2 540	—	—	—	2 630	60	M30×3	50	15 200	○	4 240
2TR2450CS	1	2 980	2 464	330	2 492	14	178	160	265	65	2 710	2 770	2 700	2 540	—	—	—	2 630	60	M30×3	50	15 200	○	4 200
2TR3000ACS	2	3 500	2 996	210	3 024	14	216	160	210	-10	3 256	3 266	3 210	3 070	3 455	96	$\phi 23$	3 140	96	M33×3	50	10 000	○	3 300
2TR3180-1CS	1	3 797	3 180	330	3 220	20	161	220	285	45	3 516	3 580	3 488	3 305	—	—	—	3 405	96	M36×3	60	20 300	○	6 390
2TR3216CS	1	3 800	3 216	330	3 248	16	203	200	285	45	3 516	3 580	3 488	3 305	—	—	—	3 405	96	M33×3	55	20 300	○	6 200



Spherical roller bearing for wind turbine generator main shaft

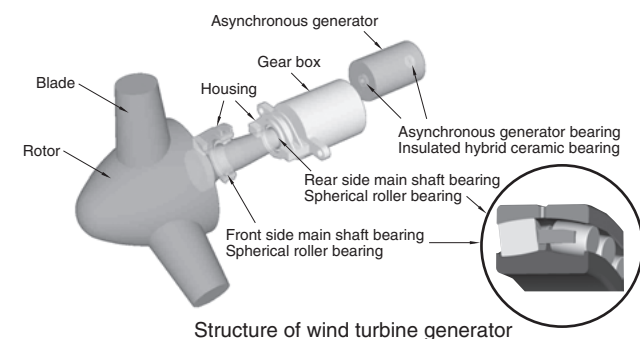
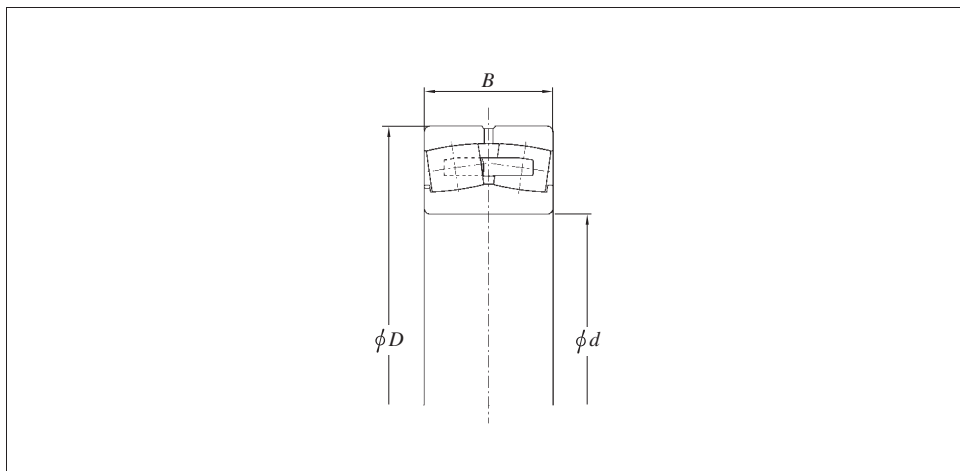

Structure of wind turbine generator

Features of spherical roller bearing for wind turbine generator main shaft

- The bearing, featuring superior radial load rating, can accommodate radial load and axial load in both directions.
- Optimization of raceway profile allows stable rotation performance.
- It absorbs misalignment in mounting and deflection. (Allowable aligning angle : 1° or more)

Bearing No.	Boundary dimensions (mm)			Bearing No.	Boundary dimensions (mm)			Bearing No.	Boundary dimensions (mm)		
	d	D	B		d	D	B		d	D	B
24156	280	460	180	24188	440	720	280	240/630	630	920	290
23060	300	460	118	24096	480	700	218	240/710	710	1 030	315
23160	300	500	160	230/530	530	780	185	230/750	750	1 090	250
23064	320	480	121	230/560	560	820	195	230/850	850	1 220	272
24064	320	480	160	240/600	600	870	272				
23188	440	720	226	230/630	630	920	212				

Back-up roll units for hot leveler

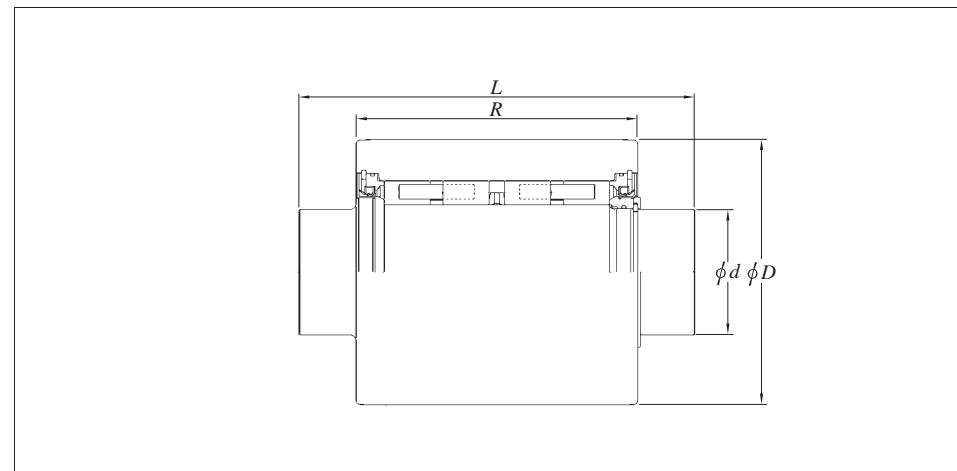

Boundary dimensions (mm)				Bearing No.	Basic load ratings (kN)		Mass (kg)
D	d	R	L		C <sub>r</sub>	C <sub>0r</sub>	
190	75	191	280	RM783C	591	964	42
200	90	230	310	RM962A	830	1 590	55
255	120	300	410	RM876B	1 440	2 890	120
310	130	370	480	RM1004	2 200	4 450	209
320	150	277	380	RM782H	1 760	3 340	171
412	180	295	420	RM736D	2 810	5 540	309
442	185	320	460	RM821C	2 910	5 350	374

Back-up roll units for tension leveler

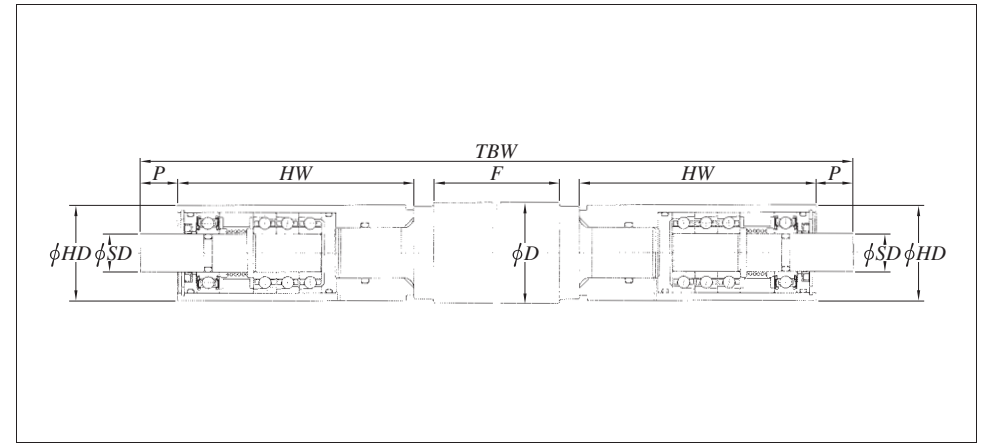
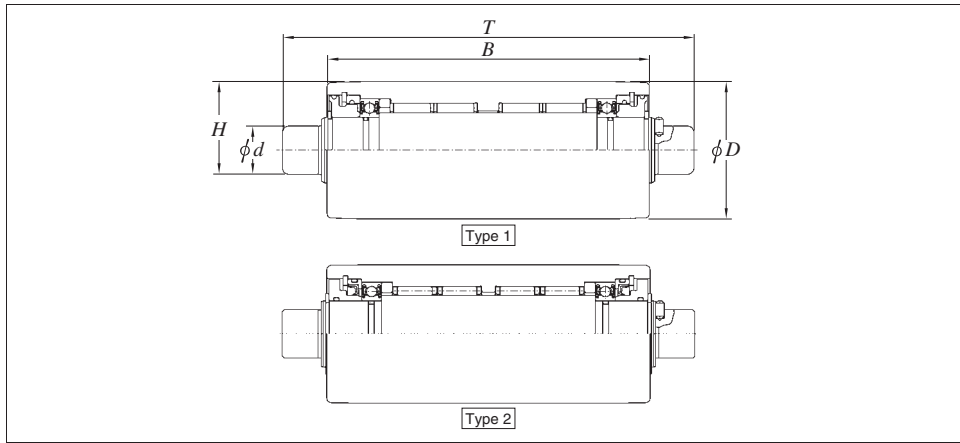

Boundary dimensions (mm)					Bearing No.	Basic load ratings (kN)		Types
D	B	d	T	H		C <sub>r</sub>	C <sub>0r</sub>	
47	115	20	145	33.5	TLW47115	58.5	113	2
50	80	24	106	37	TLD50080	42	70.5	1
	115	20	153	35	TLD50115	75.8	120	1
	180	20	218	35	TLD50180	75.8	120	1
51	150	22	191	36.5	TLD51150	75.8	120	1
	240	22	281	36.5	TLD51240	75.8	120	1
53	128	24	178	38.5	TLW53128	53.3	122	2
	218	24	268	38.5	TLW53218	53.3	122	2
63	163	22.2	204	42.5	TLD63163	92.6	187	1
	240	22	281	42.5	TLW63240	92.6	187	2
	275	22.2	316	42.5	TLD63275	92.6	187	1
	352	22	393	42.5	TLW63352	92.6	187	2
<b>Boundary dimensions (mm)</b>								
D	B	d	T	H	Bearing No.	Basic load ratings (kN)		Types
65	155	24	205	44.5	TLW65155A	92.6	187	2
	204	24	243	44.5	TLD65204	92.6	187	1
	258	24	308	44.5	TLW65258A	92.6	187	2
	275	24	314	44.5	TLD65275	92.6	187	1
75	155	30	205	52.5	TLW75155E	147	253	2
	170	30	215	52.5	TLD75170A	147	253	1
	258	30	308	52.5	TLW75258E	147	253	2
	265	30	310	52.5	TLD75265A	147	253	1
90	170	31	218	60.5	TLW90170	149	227	2
	280	31	328	60.5	TLW90280	149	227	2
130	285	69.5	348	99.75	TLW130285E	154	349	2
	450	69.5	513	99.75	TLW130450E	154	349	2

Boundary dimensions (mm)							Bearing No.	Mass (kg)
D	F	SD	HW	P	TBW	HD		
30	1 250	8	92	10	1 466	26	WTL301250S08B	7.5
	1 500	8	92	10	1 716	26	WTL301500S08A	8.9
38	1 250	12	70	10	1 410	29	WTL381250AS12F	11.5
	1 500	12	92	10	1 716	32	WTL381500S12	14.2
40	1 250	12	80	10	1 482	29	WTL401250AS12E	13.1
	1 500	12	92	10	1 716	32	WTL401500AS12D-1	15.6
46	1 900	15	94	14.75	2 133.5	38	WTL461900S15	26.0
50	1 250	12	92	10	1 466	32	WTL501250S12D	20.2
	1 500	12	92	10	1 716	32	WTL501500AS12D-1	23.3
52	1 900	15	94	14.75	2 133.5	38	WTL521900S15B-1	32.5
60	1 250	12	80	10	1 482	29	WTL601250S12E	28.6
	1 500	25	110	15	1 810	56	WTL601500S25	36.5
	1 900	15	94	14.75	2 133.5	38	WTL601900S15B-1	43.0
80	1 250	12	92	10	1 466	32	WTL801250S12D	49.7
	1 500	12	92	10	1 716	32	WTL801500S12D-1	58.8
100	1 250	12	92	10	1 466	32	WTL1001250S12D	77.1
	1 500	12	92	10	1 716	32	WTL1001500S12	92.3

Ladder bearing for converter

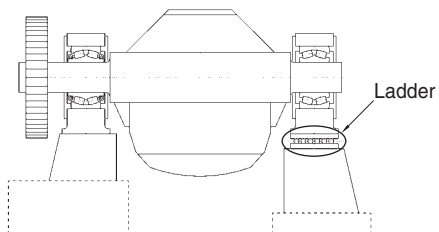
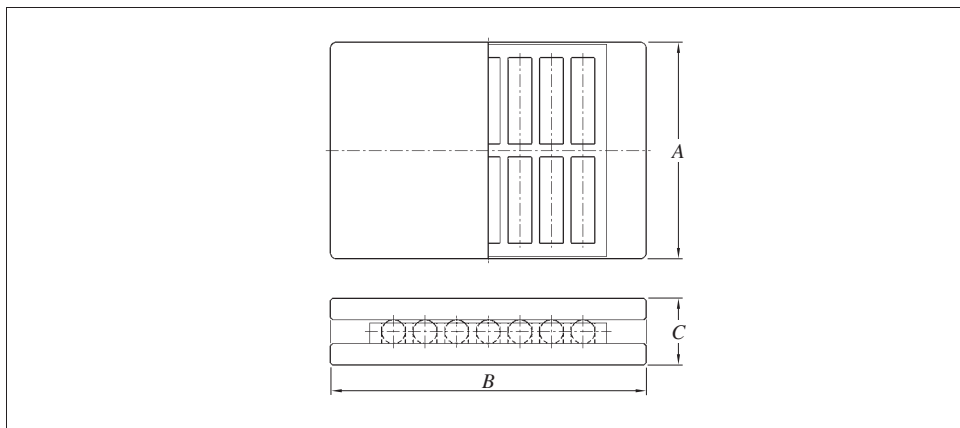

Ladder bearings smoothly absorb (let off) thermal expansion of the trunnion ring during operation.

Boundary dimensions (mm)			Bearing No.	Basic static load rating (kN) $C_{0r}$	Converter capacity (ton)
A	B	C			
83	340	90	<b>THP83X340B</b>	2 570	60
280	420	95	<b>THP280X420</b>	11 800	200
300	400	80	<b>THP300X400B</b>	6 690	150
400	400	85	<b>THP400X400</b>	14 900	200

Trunnion split bearing for converter

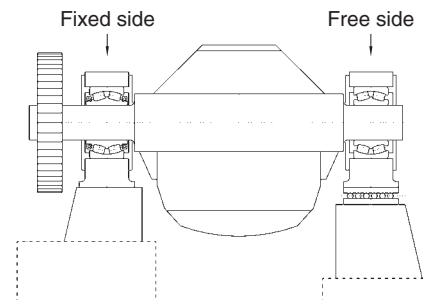

In integral type bearings, if they are required to be replaced at fixed side, all the tilting units surrounding the bearings must be removed, and exceedingly major replacement work has been required.

Use of split bearing enables easy handling of bearings and easy maintenance in the future.

Boundary dimensions (mm)				Bearing No.	Basic load ratings (kN)		Converter capacity (ton)
Bore diameter	Outside diameter	Inner ring width	Outer ring width		$C_r$	$C_{0r}$	
420	620	150	94	<b>SP/92532W33CC3</b>	2 130	4 060	160
750	1 090	395	250	<b>SP/SR750W33-1C3</b>	7 950	18 200	—
1 250	1 750	610	390	<b>SP/SR1250W33-1C3</b>	18 800	48 100	—
1 396	1 700	168+10	90	<b>SP/SC1400CS780</b>	2 780	8 620	—

Sealed bearing for sintered equipment

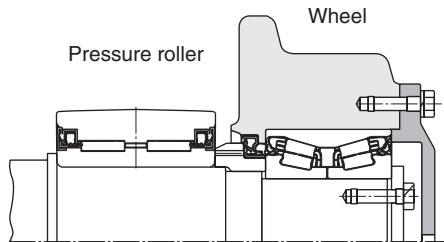
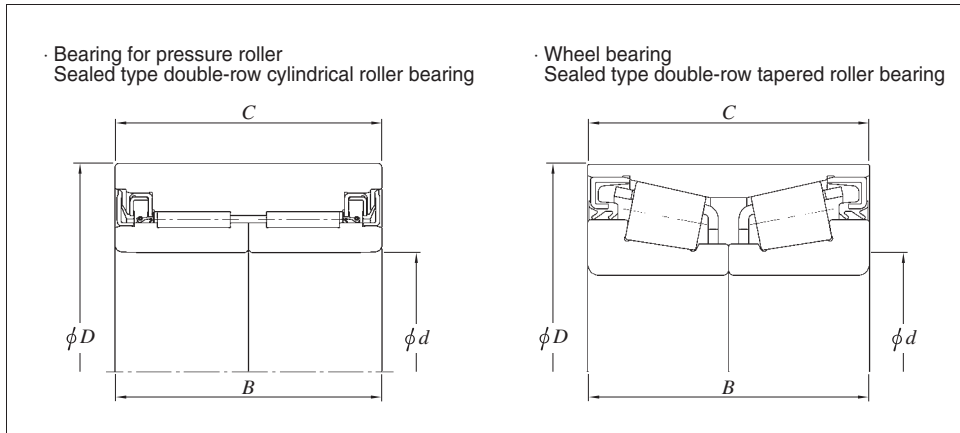

**Bearing for pressure roller**

- Special seals are provided on both sides to prevent ingress of sintered dusts.
- Special heat resistant grease withstanding high temperature and long use is adopted.
- High load rating full complement type.
- Thickness is optimized to secure strength of outer ring.
- Internal clearance of bearing is optimized.

**Wheel bearing**

- The seal mechanism prevents ingress of foreign matters into bearings.
- Special heat resistant grease withstanding high temperature and long use is adopted.
- Crowning is optimized to accommodate heavy load.
- Internal clearance of bearing is optimized.
- Bearing with the inner ring having locating snap ring to improve retrofitting performance is also available.

**Bearing for pressure roller**

Boundary dimensions (mm)				Bearing No.	Basic load ratings (kN)	
d	D	B	C		C <sub>r</sub>	C <sub>0r</sub>
120	210	132	132	24DCS21132V	449	1 400
130	210	150	150	26DCS21150V	540	1 830
160	250	140	140	32DCS25140BV	922	2 120

**Wheel bearing**

Boundary dimensions (mm)				Bearing No.	Basic load ratings (kN)	
d	D	B	C		C <sub>r</sub>	C <sub>0r</sub>
90	160	78	78	46T181608A-1RS-1	350	522
100	180	100	100	46T201810RS-5	443	676
110	200	90	90	46T222009BRS	477	704

Spherical roller bearings for shaker screens

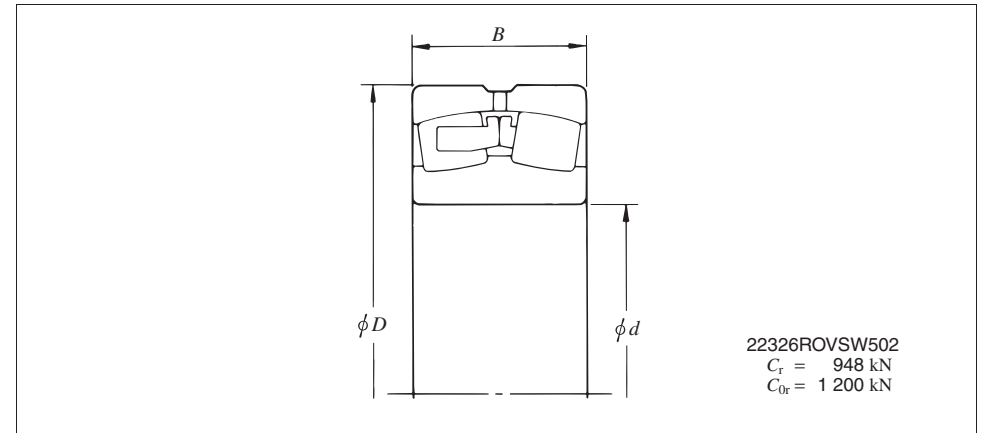

**Features of the bearings for shaker screens**

- (1) Considering lubricant flow under vibration and lubricating status of sliding surface, outer ring guided cage in special profile is used.
- (2) The cage is made of high-tensile brass casting for sufficient strength and resistance to wear.
- (3) While the bearing is rotated, peripheral speed difference occurs to the double row rollers. To prevent damages to cage including wear and breakage, separate and non-incorporated, prong type machined cage is used.
- (4) For smooth rolling motion of rollers, asymmetrical rollers having cone center are adopted.
- (5) Especially, bearing outside diameter tolerance is held to a small allowable variation.
- (6) C3 or C4 bearing internal clearance is used.

Bearing No.	Boundary dimensions (mm)		
	d	D	B
22320RROVSW502	100	215	73
22322RROVSW502	110	240	80
22324RROVSW502	120	260	86
22326RROVSW502	130	280	93
22328ROVSW502	140	300	102
22330ROVSW502	150	320	108

Bearing No.	Boundary dimensions (mm)		
	d	D	B
22332ROVSW502	160	340	114
22334ROVSW502	170	360	120
22336ROVSW502	180	380	126
22338ROVSW502	190	400	132
22340ROVSW502	200	420	138

• Bearing number of spherical roller bearings (mainly 223 series) should be followed by "R (RR) OVS W502".

Regrinding jigs for bearings for backing shafts

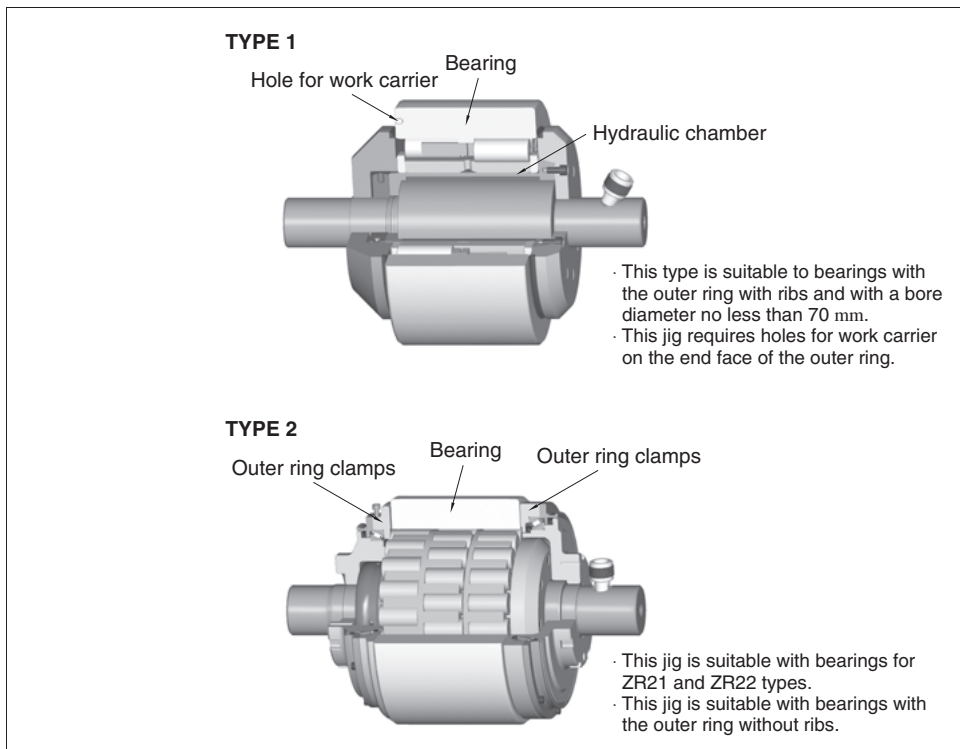

- The regrinding jig grinds the outside surfaces of bearings used on the backing shafts of multi-roll mills with high precision.
- The jig hydraulically grinds the outside surface while turning the outer ring and retaining the inner ring stationary, while it completely nullifies any clearance on the fitting surface between the jig and bearing and the internal clearance of the bearing, minimizing radial runout.
- The jig grinds bearing assemblies without need of disassembly, causing improvement in workability of installation and removal.

Oil / air lubricator for steel making and rolling equipment

- High sealing performance ..... Elimination of ingress of foreign matters by pressure in chock (housing)
- High reliability of lubrication ..... Superior lubricating performance by using oil of high viscosity and synthetic oil
- Clean working environment ..... Clean environment by recovering oil

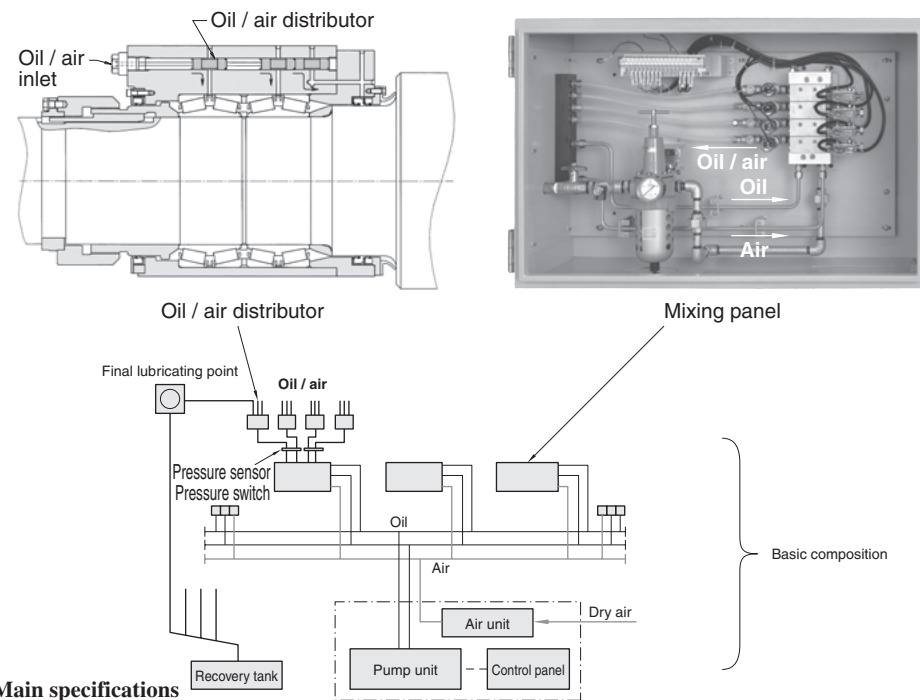

Main specifications

<b>Lubricated object</b>	Rolling mill roll neck bearing Rolling mill auxiliary roll bearing Continuous casting machine guide roll bearing Feed roll bearing, etc.
<b>Tank capacity</b>	From 250 to 2 000 ℓ
<b>Number of lubricating points</b>	1 000 points or more are available
<b>Alarm unit</b>	Respective sections in main unit End of oil and air piping
<b>Lubricated oil q'ty</b>	$Q = 0.085 \cdot d \cdot R/A$ Q : Lubricated oil q'ty cm <sup>3</sup> /hour d : Bearing bore diameter mm R : Bearing row number A : Speed coefficient (normally A = 5)

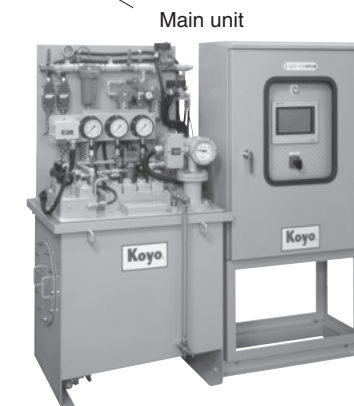

Supplementary table 1 (1) SI units and conversion factors

Mass	SI units	Other units <sup>1)</sup>	Conversion into SI units	Conversion from SI units
Angle	rad [radian(s)]	° [degree(s)] ' [minute(s)] " [second(s)]	* 1° = π /180 rad * 1' = π /10 800 rad * 1" = π /648 000 rad	1 rad = 57.295 78°
Length	m [meter(s)]	Å [Angstrom unit] μ [micron(s)] in [inch(es)] ft [foot(feet)] yd [yard(s)] mile [mile(s)]	1 Å = 10 <sup>-10</sup> m = 0.1 nm = 100 pm 1 μ = 1 μm 1 in = 25.4 mm 1 ft = 12 in = 0.304 8 m 1 yd = 3 ft = 0.914 4 m 1 mile = 5 280 ft = 1 609.344 m	1 m = 10 <sup>10</sup> Å 1 m = 39.37 in 1 m = 3.280 8 ft 1 m = 1.093 6 yd 1 km = 0.621 4 mile
Area	m <sup>2</sup>	a [are(s)] ha [hectare(s)] acre [acre(s)]	1 a = 100 m <sup>2</sup> 1 ha = 10 <sup>4</sup> m <sup>2</sup> 1 acre = 4 840 yd <sup>2</sup> = 4 046.86 m <sup>2</sup>	1 km <sup>2</sup> = 247.1 acre
Volume	m <sup>3</sup>	ℓ, L [liter(s)] cc [cubic centimeters] gal(US) [gallon(s)] floz(US) [fluid ounce(s)] barrel(US) [barrels(US)]	* 1 ℓ = 1 dm <sup>3</sup> = 10 <sup>-3</sup> m <sup>3</sup> 1 cc = 1 cm <sup>3</sup> = 10 <sup>-6</sup> m <sup>3</sup> 1 gal(US) = 231 in <sup>3</sup> = 3.785 41 dm <sup>3</sup> 1 floz(US) = 29.573 5 cm <sup>3</sup> 1 barrel(US) = 158.987 dm <sup>3</sup>	1 m <sup>3</sup> = 10 <sup>3</sup> ℓ 1 m <sup>3</sup> = 10 <sup>6</sup> cc 1 m <sup>3</sup> = 264.17 gal 1 m <sup>3</sup> = 33 814 floz 1 m <sup>3</sup> = 6.289 8 barrel
Time	s [second(s)]	min [minute(s)] h [hour(s)] d [day(s)]	* * *	
Angular velocity	rad/s			
Velocity	m/s	kn [knot(s)] m/h	* 1 kn = 1 852 m/h	1 km/h = 0.539 96 kn
Acceleration	m/s <sup>2</sup>	G	1 G = 9.806 65 m/s <sup>2</sup>	1 m/s <sup>2</sup> = 0.101 97 G
Frequency	Hz [hertz]	c/s [cycle(s)/second]	1 c/s = 1 s <sup>-1</sup> = 1 Hz	
Rotational frequency	s <sup>-1</sup>	rpm [revolutions per minute] min <sup>-1</sup> r/min	* 1 rpm = 1 / 60 s <sup>-1</sup>	1 s <sup>-1</sup> = 60 rpm
Mass	kg [kilogram(s)]	t [ton(s)] lb [pound(s)] gr [grain(s)] oz [ounce(s)] ton (UK) [ton(s)(UK)] ton (US) [ton(s)(US)] car [carat(s)]	* 1 t = 10 <sup>3</sup> kg 1 lb = 0.453 592 37 kg 1 gr = 64.798 91 mg 1 oz = 1/16 lb = 28.349 5 g 1 ton (UK) = 1 016.05 kg 1 ton (US) = 907.185 kg 1 car = 200 mg	1 kg = 2.204 6 lb 1 g = 15.432 4 gr 1 kg = 35.274 0 oz 1 t = 0.984 2 ton (UK) 1 t = 1.102 3 ton (US) 1 g = 5 car

[Note] \* : Unit can be used as an SI unit.  
No asterisk : Unit cannot be used.

Supplementary table 1 (2) SI units and conversion factors

Mass	SI units	Other units <sup>1)</sup>	Conversion into SI units	Conversion from SI units
Density	kg/m <sup>3</sup>			
Linear density	kg/m			
Momentum	kg·m/s			
Moment of momentum, angular momentum	} kg·m <sup>2</sup> /s			
Moment of inertia				
Force	N [newton(s)]	dyn [dyne(s)] kgf [kilogram-force] gf [gram-force] tf [ton-force] lbf [pound-force]	1 dyn = 10 <sup>-5</sup> N 1 kgf = 9.806 65 N 1 gf = 9.806 65×10 <sup>-3</sup> N 1 tf = 9.806 65×10 <sup>3</sup> N 1 lbf = 4.448 22 N	1 N = 10 <sup>5</sup> dyn 1 N = 0.101 97 kgf  1 N = 0.224 809 lbf
Moment of force	N·m [Newton meter(s)]	gf·cm kgf·cm kgf·m tf·m lbf·ft	1 gf·cm = 9.806 65×10 <sup>-5</sup> N·m 1 kgf·cm = 9.806 65×10 <sup>-2</sup> N·m 1 kgf·m = 9.806 65 N·m 1 tf·m = 9.806 65×10 <sup>3</sup> N·m 1 lbf·ft = 1.355 82 N·m	1 N·m = 0.101 97 kgf·m 1 N·m = 0.737 56 lbf·ft
Pressure, Normal stress	Pa [Pascal(s)] or N/m <sup>2</sup> { 1 Pa = 1 N/m <sup>2</sup> }	gf/cm <sup>2</sup> kgf/mm <sup>2</sup> kgf/m <sup>2</sup> lbf/in <sup>2</sup> bar [bar(s)] at [engineering air pressure] mH <sub>2</sub> O, mAq [meter water column] atm [atmosphere] mHg [meter mercury column] Torr [torr]	1 gf/cm <sup>2</sup> = 9.806 65×10 Pa 1 kgf/mm <sup>2</sup> = 9.806 65×10 <sup>6</sup> Pa 1 kgf/m <sup>2</sup> = 9.806 65 Pa 1 lbf/in <sup>2</sup> = 6 894.76 Pa 1 bar = 10 <sup>5</sup> Pa 1 at = 1 kgf/cm <sup>2</sup> = 9.806 65×10 <sup>4</sup> Pa 1 mH <sub>2</sub> O = 9.806 65×10 <sup>3</sup> Pa 1 atm = 101 325 Pa 1 mHg = $\frac{101\ 325}{0.76}$ Pa 1 Torr = 1 mmHg = 133.322 Pa	1 MPa = 0.101 97 kgf/mm <sup>2</sup> 1 Pa = 0.101 97 kgf/m <sup>2</sup> 1 Pa = 0.145×10 <sup>-3</sup> lbf/in <sup>2</sup> 1 Pa = 10 <sup>-2</sup> mbar  1 Pa = 7.500 6×10 <sup>-3</sup> Torr
Viscosity	Pa·s [pascal second]	P [poise] kgf·s/m <sup>2</sup>	10 <sup>-2</sup> P = 1 cP = 1 mPa·s 1 kgf·s/m <sup>2</sup> = 9.806 65 Pa·s	1 Pa·s = 0.101 97 kgf·s/m <sup>2</sup>
Kinematic viscosity	m <sup>2</sup> /s	St [stokes]	10 <sup>-2</sup> St = 1 cSt = 1 mm <sup>2</sup> /s	
Surface tension	N/m			

Supplementary table 1 (3) SI units and conversion factors

Mass	SI units	Other units <sup>1)</sup>	Conversion into SI units	Conversion from SI units																																								
Work, energy	J [joule(s)] {1 J=1 N·m}	eV [electron volt(s)] * erg [erg(s)] kgf·m lbf·ft	1 eV = (1.602 189 2± 0.000 004 6)×10 <sup>-19</sup> J 1 erg = 10 <sup>-7</sup> J 1 kgf·m = 9.806 65 J 1 lbf·ft = 1.355 82 J	1 J = 10 <sup>7</sup> erg 1 J = 0.101 97 kgf·m 1 J = 0.737 56 lbf·ft																																								
					Power	W [watt(s)]	erg / s [ergs per second] kgf·m / s PS [French horse-power] HP [horse-power (British)] lbf·ft / s	1 erg / s = 10 <sup>-7</sup> W 1 kgf·m / s = 9.806 65 W 1 PS = 75 kgf·m / s = 735.5 W 1 HP = 550 lbf·ft / s = 745.7 W 1 lbf·ft / s = 1.355 82 W	1 W = 0.101 97 kgf·m / s 1 W = 0.001 36 PS 1 W = 0.001 34 HP	Thermo-dynamic temperature	K [kelvin(s)]				Celsius temperature	°C [Celsius(s)] {t °C = (t + 273.15) K}	°F [degree(s) Fahrenheit]	t °F = $\frac{5}{9}(t - 32) °C$	t °C = $(\frac{9}{5}t + 32) °F$	Linear expansion coefficient	K <sup>-1</sup>	°C <sup>-1</sup> [per degree]			Heat	J [joule(s)] {1 J=1 N·m}	erg [erg(s)] kgf·m cal <sub>IT</sub> [I. T. calories]	1 erg = 10 <sup>-7</sup> J 1 cal <sub>IT</sub> = 4.186 8 J 1 Mcal <sub>IT</sub> = 1.163 kW·h	1 J = 10 <sup>7</sup> erg 1 J = 0.238 85 cal <sub>IT</sub> 1 kW·h = 0.86 × 10 <sup>6</sup> cal <sub>IT</sub>	Thermal conductivity	W / (m·K)	W / (m·°C) cal / (s·m·°C)	1 W / (m·°C) = 1 W / (m·K) 1 cal / (s·m·°C) = 4.186 05 W / (m·K)		Coefficient of heat transfer	W / (m <sup>2</sup> ·K)	W / (m <sup>2</sup> ·°C) cal / (s·m <sup>2</sup> ·°C)	1 W / (m <sup>2</sup> ·°C) = 1 W / (m <sup>2</sup> ·K) 1 cal / (s·m <sup>2</sup> ·°C) = 4.186 05 W / (m <sup>2</sup> ·K)		Heat capacity	J/K	J / °C	1 J / °C = 1 J / K	
Power	W [watt(s)]	erg / s [ergs per second] kgf·m / s PS [French horse-power] HP [horse-power (British)] lbf·ft / s	1 erg / s = 10 <sup>-7</sup> W 1 kgf·m / s = 9.806 65 W 1 PS = 75 kgf·m / s = 735.5 W 1 HP = 550 lbf·ft / s = 745.7 W 1 lbf·ft / s = 1.355 82 W	1 W = 0.101 97 kgf·m / s 1 W = 0.001 36 PS 1 W = 0.001 34 HP																																								
					Thermo-dynamic temperature	K [kelvin(s)]				Celsius temperature	°C [Celsius(s)] {t °C = (t + 273.15) K}	°F [degree(s) Fahrenheit]	t °F = $\frac{5}{9}(t - 32) °C$	t °C = $(\frac{9}{5}t + 32) °F$	Linear expansion coefficient	K <sup>-1</sup>	°C <sup>-1</sup> [per degree]			Heat	J [joule(s)] {1 J=1 N·m}	erg [erg(s)] kgf·m cal <sub>IT</sub> [I. T. calories]	1 erg = 10 <sup>-7</sup> J 1 cal <sub>IT</sub> = 4.186 8 J 1 Mcal <sub>IT</sub> = 1.163 kW·h	1 J = 10 <sup>7</sup> erg 1 J = 0.238 85 cal <sub>IT</sub> 1 kW·h = 0.86 × 10 <sup>6</sup> cal <sub>IT</sub>	Thermal conductivity	W / (m·K)	W / (m·°C) cal / (s·m·°C)	1 W / (m·°C) = 1 W / (m·K) 1 cal / (s·m·°C) = 4.186 05 W / (m·K)		Coefficient of heat transfer	W / (m <sup>2</sup> ·K)	W / (m <sup>2</sup> ·°C) cal / (s·m <sup>2</sup> ·°C)	1 W / (m <sup>2</sup> ·°C) = 1 W / (m <sup>2</sup> ·K) 1 cal / (s·m <sup>2</sup> ·°C) = 4.186 05 W / (m <sup>2</sup> ·K)		Heat capacity	J/K	J / °C	1 J / °C = 1 J / K		Massic heat capacity	J / (kg·K)	J / (kg·°C)		
Thermo-dynamic temperature	K [kelvin(s)]																																											
Celsius temperature	°C [Celsius(s)] {t °C = (t + 273.15) K}	°F [degree(s) Fahrenheit]	t °F = $\frac{5}{9}(t - 32) °C$	t °C = $(\frac{9}{5}t + 32) °F$																																								
					Linear expansion coefficient	K <sup>-1</sup>	°C <sup>-1</sup> [per degree]			Heat	J [joule(s)] {1 J=1 N·m}	erg [erg(s)] kgf·m cal <sub>IT</sub> [I. T. calories]	1 erg = 10 <sup>-7</sup> J 1 cal <sub>IT</sub> = 4.186 8 J 1 Mcal <sub>IT</sub> = 1.163 kW·h	1 J = 10 <sup>7</sup> erg 1 J = 0.238 85 cal <sub>IT</sub> 1 kW·h = 0.86 × 10 <sup>6</sup> cal <sub>IT</sub>	Thermal conductivity	W / (m·K)	W / (m·°C) cal / (s·m·°C)	1 W / (m·°C) = 1 W / (m·K) 1 cal / (s·m·°C) = 4.186 05 W / (m·K)		Coefficient of heat transfer	W / (m <sup>2</sup> ·K)	W / (m <sup>2</sup> ·°C) cal / (s·m <sup>2</sup> ·°C)	1 W / (m <sup>2</sup> ·°C) = 1 W / (m <sup>2</sup> ·K) 1 cal / (s·m <sup>2</sup> ·°C) = 4.186 05 W / (m <sup>2</sup> ·K)		Heat capacity	J/K	J / °C	1 J / °C = 1 J / K		Massic heat capacity	J / (kg·K)	J / (kg·°C)												
Linear expansion coefficient	K <sup>-1</sup>	°C <sup>-1</sup> [per degree]																																										
Heat	J [joule(s)] {1 J=1 N·m}	erg [erg(s)] kgf·m cal <sub>IT</sub> [I. T. calories]	1 erg = 10 <sup>-7</sup> J 1 cal <sub>IT</sub> = 4.186 8 J 1 Mcal <sub>IT</sub> = 1.163 kW·h	1 J = 10 <sup>7</sup> erg 1 J = 0.238 85 cal <sub>IT</sub> 1 kW·h = 0.86 × 10 <sup>6</sup> cal <sub>IT</sub>																																								
					Thermal conductivity	W / (m·K)	W / (m·°C) cal / (s·m·°C)	1 W / (m·°C) = 1 W / (m·K) 1 cal / (s·m·°C) = 4.186 05 W / (m·K)		Coefficient of heat transfer	W / (m <sup>2</sup> ·K)	W / (m <sup>2</sup> ·°C) cal / (s·m <sup>2</sup> ·°C)	1 W / (m <sup>2</sup> ·°C) = 1 W / (m <sup>2</sup> ·K) 1 cal / (s·m <sup>2</sup> ·°C) = 4.186 05 W / (m <sup>2</sup> ·K)		Heat capacity	J/K	J / °C	1 J / °C = 1 J / K		Massic heat capacity	J / (kg·K)	J / (kg·°C)																						
Thermal conductivity	W / (m·K)	W / (m·°C) cal / (s·m·°C)	1 W / (m·°C) = 1 W / (m·K) 1 cal / (s·m·°C) = 4.186 05 W / (m·K)																																									
					Coefficient of heat transfer	W / (m <sup>2</sup> ·K)	W / (m <sup>2</sup> ·°C) cal / (s·m <sup>2</sup> ·°C)	1 W / (m <sup>2</sup> ·°C) = 1 W / (m <sup>2</sup> ·K) 1 cal / (s·m <sup>2</sup> ·°C) = 4.186 05 W / (m <sup>2</sup> ·K)		Heat capacity	J/K	J / °C	1 J / °C = 1 J / K		Massic heat capacity	J / (kg·K)	J / (kg·°C)																											
Coefficient of heat transfer	W / (m <sup>2</sup> ·K)	W / (m <sup>2</sup> ·°C) cal / (s·m <sup>2</sup> ·°C)	1 W / (m <sup>2</sup> ·°C) = 1 W / (m <sup>2</sup> ·K) 1 cal / (s·m <sup>2</sup> ·°C) = 4.186 05 W / (m <sup>2</sup> ·K)																																									
					Heat capacity	J/K	J / °C	1 J / °C = 1 J / K		Massic heat capacity	J / (kg·K)	J / (kg·°C)																																
Heat capacity	J/K	J / °C	1 J / °C = 1 J / K																																									
					Massic heat capacity	J / (kg·K)	J / (kg·°C)																																					
Massic heat capacity	J / (kg·K)	J / (kg·°C)																																										

[Note] \* : Unit can be used as an SI unit.  
No asterisk : Unit cannot be used.

Supplementary table 2 Inch/millimeter conversion

Inch	Inches										
	0	1	2	3	4	5	6	7	8	9	10
	mm										
0	0	0	0	0	0	0	0	0	0	0	0
1/64	0.015625	0.3969	25.7969	51.1969	76.5969	101.9969	127.3969	152.7969	178.1969	203.5969	228.9969
1/32	0.03125	0.7938	26.1938	51.5938	76.9938	102.3938	127.7938	153.1938	178.5938	203.9938	229.3938
3/64	0.046875	1.1906	26.5906	51.9906	77.3906	102.7906	128.1906	153.5906	178.9906	204.3906	229.7906
1/16	0.0625	1.5875	26.9875	52.3875	77.7875	103.1875	128.5875	153.9875	179.3875	204.7875	230.1875
5/64	0.078125	1.9844	27.3844	52.7844	78.1844	103.5844	128.9844	154.3844	179.7844	205.1844	230.5844
3/32	0.09375	2.3812	27.7812	53.1812	78.5812	103.9812	129.3812	154.7812	180.1812	205.5812	230.9812
7/64	0.109375	2.7781	28.1781	53.5781	78.9781	104.3781	129.7781	155.1781	180.5781	205.9781	231.3781
1/8	0.125	3.1750	28.5750	53.9750	79.3750	104.7750	130.1750	155.5750	180.9750	206.3750	231.7750
9/64	0.140625	3.5719	28.9719	54.3719	79.7719	105.1719	130.5719	155.9719	181.3719	206.7719	232.1719
5/32	0.15625	3.9688	29.3688	54.7688	80.1688	105.5688	130.9688	156.3688	181.7688	207.1688	232.5688
11/64	0.171875	4.3656	29.7656	55.1656	80.5656	105.9656	131.3656	156.7656	182.1656	207.5656	232.9656
3/16	0.1875	4.7625	30.1625	55.5625	80.9625	106.3625	131.7625	157.1625	182.5625	207.9625	233.3625
13/64	0.203125	5.1594	30.5594	55.9594	81.3594	106.7594	132.1594	157.5594	182.9594	208.3594	233.7594
7/32	0.21875	5.5562	30.9562	56.3562	81.7562	107.1562	132.5562	157.9562	183.3562	208.7562	234.1562
15/64	0.234375	5.9531	31.3531	56.7531	82.1531	107.5531	132.9531	158.3531	183.7531	209.1531	234.5531
1/4	0.25	6.3500	31.7500	57.1500	82.5500	107.9500	133.3500	158.7500	184.1500	209.5500	234.9500
17/64	0.265625	6.7469	32.1469	57.5469	82.9469	108.3469	133.7469	159.1469	184.5469	209.9469	235.3469
9/32	0.28125	7.1438	32.5438	57.9438	83.3438	108.7438	134.1438	159.5438	184.9438	210.3438	235.7438
19/64	0.296875	7.5406	32.9406	58.3406	83.7406	109.1406	134.5406	159.9406	185.3406	210.7406	236.1406
5/16	0.3125	7.9375	33.3375	58.7375	84.1375	109.5375	134.9375	160.3375	185.7375	211.1375	236.5375
21/64	0.328125	8.3344	33.7344	59.1344	84.5344	109.9344	135.3344	160.7344	186.1344	211.5344	236.9344
11/32	0.34375	8.7312	34.1312	59.5312	84.9312	110.3312	135.7312	161.1312	186.5312	211.9312	237.3312
23/64	0.359375	9.1281	34.5281	59.9281	85.3281	110.7281	136.1281	161.5281	186.9281	212.3281	237.7281
3/8	0.375	9.5250	34.9250	60.3250	85.7250	111.1250	136.5250	161.9250	187.3250	212.7250	238.1250
25/64	0.390625	9.9219	35.3219	60.7219	86.1219	111.5219	136.9219	162.3219	187.7219	213.1219	238.5219
13/32	0.40625	10.3188	35.7188	61.1188	86.5188	111.9188	137.3188	162.7188	188.1188	213.5188	238.9188
27/64	0.421875	10.7156	36.1156	61.5156	86.9156	112.3156	137.7156	163.1156	188.5156	213.9156	239.3156
7/16	0.4375	11.1125	36.5125	61.9125	87.3125	112.7125	138.1125	163.5125	188.9125	214.3125	239.7125
29/64	0.453125	11.5094	36.9094	62.3094	87.7094	113.1094	138.5094	163.9094	189.3094	214.7094	240.1094
15/32	0.46875	11.9062	37.3062	62.7062	88.1062	113.5062	138.9062	164.3062	189.7062	215.1062	240.5062
31/64	0.484375	12.3031	37.7031	63.1031	88.5031	113.9031	139.3031	164.7031	190.1031	215.5031	240.9031
1/2	0.5	12.7000	38.1000	63.5000	88.9000	114.3000	139.7000	165.1000	190.5000	215.9000	241.3000
33/64	0.515625	13.0969	38.4969	63.8969	89.2969	114.6969	140.0969	165.4969	190.8969	216.2969	241.6969
17/32	0.53125	13.4938	38.8938	64.2938	89.6938	115.0938	140.4938	165.8938	191.2938	216.6938	242.0938
35/64	0.546875	13.8906	39.2906	64.6906	90.0906	115.4906	140.8906	166.2906	191.6906	217.0906	242.4906
9/16	0.5625	14.2875	39.6875	65.0875	90.4875	115.8875	141.2875	166.6875	192.0875	217.4875	242.8875
37/64	0.578125	14.6844	40.0844	65.4844	90.8844	116.2844	141.6844	167.0844	192.4844	217.8844	243.2844
19/32	0.59375	15.0812	40.4812	65.8812	91.2812	116.6812	142.0812	167.4812	192.8812	218.2812	243.6812
39/64	0.609375	15.4781	40.8781	66.2781	91.6781	117.0781	142.4781	167.8781	193.2781	218.6781	244.0781
5/8	0.625	15.8750	41.2750	66.6750	92.0750	117.4750	142.8750	168.2750	193.6750	219.0750	244.4750
41/64	0.640625	16.2719	41.6719	67.0719	92.4719	117.8719	143.2719	168.6719	194.0719	219.4719	244.8719
21/32	0.65625	16.6688	42.0688	67.4688	92.8688	118.2688	143.6688	169.0688	194.4688	219.8688	245.2688
43/64	0.671875	17.0656	42.4656	67.8656	93.2656	118.6656	144.0656	169.4656	194.8656	220.2656	245.6656
11/16	0.6875	17.4625	42.8625	68.2625	93.6625	119.0625	144.4625	169.8625	195.2625	220.6625	246.0625
45/64	0.703125	17.8594	43.2594	68.6594	94.0594	119.4594	144.8594	170.2594	195.6594	221.0594	246.4594
23/32	0.71875	18.2562	43.6562	69.0562	94.4562	119.8562	145.2562	170.6562	196.0562	221.4562	246.8562
47/64	0.734375	18.6531	44.0531	69.4531	94.8531	120.2531	145.6531	171.0531	196.4531	221.8531	247.2531
3/4	0.75	19.0500	44.4500	69.8500	95.2500	120.6500	146.0500	171.4500	196.8500	222.2500	247.6500
49/64	0.765625	19.4469	44.8469	70.2469	95.6469	121.0469	146.4469	171.8469	197.2469	222.6469	248.0469
25/32	0.78125	19.8438	45.2438	70.6438	96.0438	121.4438	146.8438	172.2438	197.6438	223.0438	248.4438
51/64	0.796875	20.2406	45.6406	71.0406	96.4406	121.8406	147.2406	172.6406	198.0406	223.4406	248.8406
13/16	0.8125	20.6375	46.0375	71.4375	96.8375	122.2375	147.6375	173.0375	198.4375	223.8375	249.2375
53/64	0.828125	21.0344	46.4344	71.8344	97.2344	122.6344	148.0344	173.4344	198.8344	224.2344	249.6344
27/32	0.84375	21.4312	46.8312	72.2312	97.6312	123.0312	148.4312	173.8312	199.2312	224.6312	250.0312
55/64	0.859375	21.8281	47.2281	72.6281	98.0281	123.4281	148.8281	174.2281	199.6281	225.0281	250.4281
7/8	0.875	22.2250	47.6250	73.0250	98.4250	123.8250	149.2250	174.6250	200.0250	225.4250	250.8250
57/64	0.890625	22.6219	48.0219	73.4219	98.8219	124.2219	149.6219	175.0219	200.4219	225.8219	251.2219
29/32	0.90625	23.0188	48.4188	73.8188	99.2188	124.6188	150.0188	175.4188	200.8188	226.2188	251.6188
59/64	0.921875	23.4156	48.8156	74.2156	99.6156	125.0156	150.4156	175.8156	201.2156	226.6156	252.0156
15/16	0.9375	23.8125	49.2125	74.6125	100.0125	125.4125	150.8125	176.2125	201.6125	227.0125	252.4125
61/64	0.953125	24.2094	49.6094	75.0094	100.4094	125.8094	151.2094	176.6094	202.0094	227.4094	252.8094
31/32	0.96875	24.6062	50.0062	75.4062	100.8062	126.2062	151.6062	177.0062	202.4062	227.8062	253.2062
63/64	0.										

Supplementary table 3 Steel hardness conversion

Rockwell C-scale 1 471.0 N (150 kgf)	Vicker's	Brinell		Rockwell		Shore
		Standard ball	Tungsten carbide ball	A-scale 588.4 N (60 kgf)	B-scale 980.7 N (100 kgf)	
68	940			85.6		97
67	900			85.0		95
66	865			84.5		92
65	832		739	83.9		91
64	800		722	83.4		88
63	772		705	82.8		87
62	746		688	82.3		85
61	720		670	81.8		83
60	697		654	81.2		81
59	674		634	80.7		80
58	653		615	80.1		78
57	633		595	79.6		76
56	613		577	79.0		75
55	595	-	560	78.5		74
54	577	-	543	78.0		72
53	560	-	525	77.4		71
52	544	500	512	76.8		69
51	528	487	496	76.3		68
50	513	475	481	75.9		67
49	498	464	469	75.2		66
48	484	451	455	74.7		64
47	471	442	443	74.1		63
46	458	432	432	73.6		62
45	446		421	73.1		60
44	434		409	72.5		58
43	423		400	72.0		57
42	412		390	71.5		56
41	402		381	70.9		55
40	392		371	70.4	-	54
39	382		362	69.9	-	52
38	372		353	69.4	-	51
37	363		344	68.9	-	50
36	354		336	68.4	(109.0)	49
35	345		327	67.9	(108.5)	48
34	336		319	67.4	(108.0)	47
33	327		311	66.8	(107.5)	46
32	318		301	66.3	(107.0)	44
31	310		294	65.8	(106.0)	43
30	302		286	65.3	(105.5)	42
29	294		279	64.7	(104.5)	41
28	286		271	64.3	(104.0)	41
27	279		264	63.8	(103.0)	40
26	272		258	63.3	(102.5)	38
25	266		253	62.8	(101.5)	38
24	260		247	62.4	(101.0)	37
23	254		243	62.0	100.0	36
22	248		237	61.5	99.0	35
21	243		231	61.0	98.5	35
20	238		226	60.5	97.8	34
(18)	230		219	-	96.7	33
(16)	222		212	-	95.5	32
(14)	213		203	-	93.9	31
(12)	204		194	-	92.3	29
(10)	196		187		90.7	28
( 8)	188		179		89.5	27
( 6)	180		171		87.1	26
( 4)	173		165		85.5	25
( 2)	166		158		83.5	24
( 0)	160		152		81.7	24

Supplementary table 4 Viscosity conversion

Kinematic viscosity mm <sup>2</sup> /s	Saybolt SUS (second)		Redwood R (second)		Engler E (degree)
	100 °F	210 °F	50 °C	100 °C	
	2	32.6	32.8	30.8	
3	36.0	36.3	33.3	33.7	1.22
4	39.1	39.4	35.9	36.5	1.31
5	42.3	42.6	38.5	39.1	1.40
6	45.5	45.8	41.1	41.7	1.48
7	48.7	49.0	43.7	44.3	1.56
8	52.0	52.4	46.3	47.0	1.65
9	55.4	55.8	49.1	50.0	1.75
10	58.8	59.2	52.1	52.9	1.84
11	62.3	62.7	55.1	56.0	1.93
12	65.9	66.4	58.2	59.1	2.02
13	69.6	70.1	61.4	62.3	2.12
14	73.4	73.9	64.7	65.6	2.22
15	77.2	77.7	68.0	69.1	2.32
16	81.1	81.7	71.5	72.6	2.43
17	85.1	85.7	75.0	76.1	2.54
18	89.2	89.8	78.6	79.7	2.64
19	93.3	94.0	82.1	83.6	2.76
20	97.5	98.2	85.8	87.4	2.87
21	102	102	89.5	91.3	2.98
22	106	107	93.3	95.1	3.10
23	110	111	97.1	98.9	3.22
24	115	115	101	103	3.34
25	119	120	105	107	3.46
26	123	124	109	111	3.58
27	128	129	112	115	3.70
28	132	133	116	119	3.82
29	137	138	120	123	3.95
30	141	142	124	127	4.07
31	145	146	128	131	4.20
32	150	150	132	135	4.32
33	154	155	136	139	4.45
34	159	160	140	143	4.57
35	163	164	144	147	4.70
36	168	170	148	151	4.83
37	172	173	153	155	4.96
38	177	178	156	159	5.08
39	181	183	160	164	5.21
40	186	187	164	168	5.34
41	190	192	168	172	5.47
42	195	196	172	176	5.59
43	199	201	176	180	5.72
44	204	205	180	185	5.85
45	208	210	184	189	5.98
46	213	215	188	193	6.11
47	218	219	193	197	6.24
48	222	224	197	202	6.37
49	227	228	201	206	6.50
50	231	233	205	210	6.63
55	254	256	225	231	7.24
60	277	279	245	252	7.90
65	300	302	266	273	8.55
70	323	326	286	294	9.21
75	346	349	306	315	9.89
80	371	373	326	336	10.5
85	394	397	347	357	11.2
90	417	420	367	378	11.8
95	440	443	387	399	12.5
100	464	467	408	420	13.2
120	556	560	490	504	15.8
140	649	653	571	588	18.4
160	742	747	653	672	21.1
180	834	840	734	757	23.7
200	927	933	816	841	26.3
250	1 159	1 167	1 020	1 051	32.9
300	1 391	1 400	1 224	1 241	39.5

[Remark] 1 mm<sup>2</sup> / s = 1 cSt (centi stokes)



Supplementary table 5 Shaft tolerances (deviation from nominal dimensions)

Unit :  $\mu\text{m}$  (Refer.)

Nominal shaft dia. (mm)		Deviation classes of shaft dia.																					Nominal shaft dia. (mm)		$\Delta d_{mp}^{(1)}$ of bearing (class 0)						
over	up to	d 6	e 6	f 6	g 5	g 6	h 5	h 6	h 7	h 8	h 9	h 10	js 5	js 6	js 7	j 5	j 6	k 5	k 6	k 7	m 5	m 6	m 7	n 5		n 6	p 6	r 6	r 7	over	up to
30	50	-80 -96	-50 -66	-25 -41	-9 -20	-9 -25	0 -11	0 -16	0 -25	0 -39	0 -62	0 -100	$\pm 5.5$	$\pm 8$	$\pm 12.5$	+6 -5	+11 -5	+13 +2	+18 +2	+27 +2	+20 +9	+25 +9	+34 +9	+28 +17	+33 +17	+42 +26	+50 +34	+59 +34	30	50	0 -12
50	80	-100 -119	-60 -79	-30 -49	-10 -23	-10 -29	0 -13	0 -19	0 -30	0 -46	0 -74	0 -120	$\pm 6.5$	$\pm 9.5$	$\pm 15$	+6 -7	+12 -7	+15 +2	+21 +2	+32 +2	+24 +11	+30 +11	+41 +11	+33 +20	+39 +20	+51 +32	+60 +41	+71 +41	50	65	0 -15
		65	80	+62 +43	+73 +43	+73 +86	+51 +51	+80 +89	+94 +54	+105 +65	+108 +68	+123 +77	+146 +94	+150 +98	+155 +155	+189 +126	+210 +210	+250 +250	+265 +185	+300 +300	+330 +330	+425 +300	+455 +330	+492 +140	+520 +370	+550 +400	+1800 +1800	+1800 +1800	1800	2000	0 -200
80	120	-120 -142	-72 -94	-36 -58	-12 -27	-12 -34	0 -15	0 -22	0 -35	0 -54	0 -87	0 -140	$\pm 7.5$	$\pm 11$	$\pm 17.5$	+6 -9	+13 -9	+18 +3	+25 +3	+38 +3	+28 +13	+35 +13	+48 +13	+38 +23	+45 +23	+59 +37	+76 +89	+89 +54	80	100	0 -20
		120	180	+88 +63	+103 +63	+106 +77	+109 +80	+123 +77	+126 +80	+130 +84	+144 +108	+165 +108	+189 +126	+210 +210	+250 +250	+265 +185	+300 +300	+330 +330	+425 +300	+455 +330	+492 +140	+520 +370	+550 +400	+1800 +1800	+1800 +1800	1800	2000	0 -200			
120	180	-145 -170	-85 -110	-43 -68	-14 -32	-14 -39	0 -18	0 -25	0 -40	0 -63	0 -100	0 -160	$\pm 9$	$\pm 12.5$	$\pm 20$	+7 -11	+14 -11	+21 +3	+28 +3	+43 +3	+33 +15	+40 +15	+55 +15	+45 +27	+52 +27	+68 +43	+90 +65	+105 +65	120	160	0 -25
		160	180	+93 +68	+108 +68	+106 +77	+109 +80	+123 +77	+126 +80	+130 +84	+144 +108	+165 +108	+189 +126	+210 +210	+250 +250	+265 +185	+300 +300	+330 +330	+425 +300	+455 +330	+492 +140	+520 +370	+550 +400	+1800 +1800	+1800 +1800	1800	2000	0 -200			
180	250	-170 -199	-100 -129	-50 -79	-15 -35	-15 -44	0 -20	0 -29	0 -46	0 -72	0 -115	0 -185	$\pm 10$	$\pm 14.5$	$\pm 23$	+7 -13	+16 -13	+24 +4	+33 +4	+50 +4	+37 +17	+46 +17	+63 +17	+51 +31	+60 +31	+79 +50	+109 +80	+126 +80	180	225	0 -30
		225	250	+113 +84	+130 +84	+144 +108	+165 +108	+189 +126	+210 +210	+250 +250	+265 +185	+300 +300	+330 +330	+425 +300	+455 +330	+492 +140	+520 +370	+550 +400	+1800 +1800	+1800 +1800	1800	2000	0 -200								
250	315	-190 -222	-110 -142	-56 -88	-17 -40	-17 -49	0 -23	0 -32	0 -52	0 -81	0 -130	0 -210	$\pm 11.5$	$\pm 16$	$\pm 26$	+7 -16	+16 -16	+27 +4	+36 +4	+56 +4	+43 +20	+52 +20	+72 +20	+57 +34	+66 +34	+88 +56	+126 +94	+146 +94	250	280	0 -35
		280	315	+130 +84	+146 +94	+165 +108	+189 +126	+210 +210	+250 +250	+265 +185	+300 +300	+330 +330	+425 +300	+455 +330	+492 +140	+520 +370	+550 +400	+1800 +1800	+1800 +1800	1800	2000	0 -200									
315	400	-210 -246	-125 -161	-62 -98	-18 -43	-18 -54	0 -25	0 -36	0 -57	0 -89	0 -140	0 -230	$\pm 12.5$	$\pm 18$	$\pm 28.5$	+7 -18	+18 -18	+29 +4	+40 +4	+61 +4	+46 +21	+57 +21	+78 +21	+62 +37	+73 +37	+98 +62	+144 +108	+165 +108	315	355	0 -40
		355	400	+150 +114	+171 +114	+189 +126	+210 +210	+250 +250	+265 +185	+300 +300	+330 +330	+425 +300	+455 +330	+492 +140	+520 +370	+550 +400	+1800 +1800	+1800 +1800	1800	2000	0 -200										
400	500	-230 -270	-135 -175	-68 -108	-20 -47	-20 -60	0 -27	0 -40	0 -63	0 -97	0 -155	0 -250	$\pm 13.5$	$\pm 20$	$\pm 31.5$	+7 -20	+20 -20	+32 +5	+45 +5	+68 +5	+50 +23	+63 +23	+86 +23	+67 +40	+80 +40	+108 +68	+166 +189	+189 +126	400	450	0 -45
		450	500	+172 +132	+195 +132	+210 +210	+250 +250	+265 +185	+300 +300	+330 +330	+425 +300	+455 +330	+492 +140	+520 +370	+550 +400	+1800 +1800	+1800 +1800	1800	2000	0 -200											
500	630	-260 -304	-145 -189	-76 -120	-22 -54	-22 -66	0 -32	0 -44	0 -70	0 -110	0 -175	0 -280	$\pm 16$	$\pm 22$	$\pm 35$	-	-	+32 0	+44 0	+70 0	+58 +26	+70 +26	+96 +26	+76 +44	+88 +44	+122 +78	+194 +150	+220 +150	500	560	0 -50
		560	630	+199 +155	+225 +155	+250 +175	+265 +185	+300 +300	+330 +330	+425 +300	+455 +330	+492 +140	+520 +370	+550 +400	+1800 +1800	+1800 +1800	1800	2000	0 -200												
630	800	-290 -340	-160 -210	-80 -130	-24 -60	-24 -74	0 -36	0 -50	0 -80	0 -125	0 -200	0 -320	$\pm 18$	$\pm 25$	$\pm 40$	-	-	+36 0	+50 0	+80 0	+66 +30	+80 +30	+110 +30	+86 +50	+100 +50	+138 +88	+225 +175	+255 +175	630	710	0 -75
		710	800	+235 +185	+265 +185	+300 +300	+330 +330	+425 +300	+455 +330	+492 +140	+520 +370	+550 +400	+1800 +1800	+1800 +1800	1800	2000	0 -200														
800	1000	-320 -376	-170 -226	-86 -142	-26 -66	-26 -82	0 -40	0 -56	0 -90	0 -140	0 -230	0 -360	$\pm 20$	$\pm 28$	$\pm 45$	-	-	+40 0	+56 0	+90 0	+74 +34	+90 +34	+124 +34	+96 +56	+112 +56	+156 +100	+266 +210	+300 +210	800	900	0 -100
		900	1000	+276 +220	+310 +220	+355 +250	+365 +260	+408 +330	+455 +330	+492 +140	+520 +370	+550 +400	+1800 +1800	+1800 +1800	1800	2000	0 -200														
1000	1250	-350 -416	-195 -261	-98 -164	-28 -75	-28 -94	0 -47	0 -66	0 -105	0 -165	0 -260	0 -420	$\pm 23.5$	$\pm 33$	$\pm 52.5$	-	-	+47 0	+66 0	+105 0	+87 +40	+106 +40	+145 +40	+113 +66	+132 +66	+186 +120	+316 +250	+355 +250	1000	1120	0 -125
		1120	1250	+326 +260	+365 +260	+408 +330	+455 +330	+492 +140	+520 +370	+550 +400	+1800 +1800	+1800 +1800	1800	2000	0 -200																
1250	1600	-390 -468	-220 -298	-110 -188	-30 -85	-30 -108	0 -55	0 -78	0 -125	0 -195	0 -310	0 -500	$\pm 27.5$	$\pm 39$	$\pm 62.5$	-	-	+55 0	+78 0	+125 0	+103 +48	+126 +48	+173 +48	+133 +78	+156 +78	+218 +140	+378 +300	+425 +300	1250	1400	0 -160
		1400	1600	+408 +330	+455 +330	+492 +140	+520 +370	+550 +400	+1800 +1800	+1800 +1800	1800	2000	0 -200																		
1600	2000	-430 -522	-240 -332	-120 -212	-32 -97	-32 -124	0 -65	0 -92	0 -150	0 -230	0 -370	0 -600	$\pm 32.5$	$\pm 46$	$\pm 75$	-	-	+65 0	+92 0	+150 0	+123 +58	+150 +58	+208 +58	+157 +92	+184 +92	+262 +170	+462 +370	+520 +370	1600	1800	0 -200
		1800	2000	+492 +400	+550 +400	+600 +400	+660 +400	+720 +400	+780 +400	+840 +400	+900 +400	+960 +400	+1020 +400	+1080 +400	+1140 +400	+1200 +400	+1260 +400	+1320 +400	+1380 +400	+1440 +400	+1500 +400	+1560 +400	+1620 +400	+1680 +400	+1740 +400	+1800 +400	+1860 +400	+1920 +400	+1980 +400	+2040 +400	+2100 +400

[Note] 1)  $\Delta d_{mp}$  : single plane mean bore diameter deviation

Supplementary table 6 Housing bore tolerances (deviation from nominal dimensions)

Unit :  $\mu\text{m}$  (Refer.)

Nominal Bore dia. (mm)		Deviation classes of housing bore																			Nominal Bore dia. (mm)		$\Delta D_{mp}^{(1)}$ of bearing (class 0)										
over	up to	E 6	F 6	F 7	G 6	G 7	H 6	H 7	H 8	H 9	H 10	JS 5	JS 6	JS 7	J 6	J 7	K 5	K 6	K 7	M 5	M 6	M 7		N 5	N 6	N 7	P 6	P 7	R 7	over	up to		
50	80	+ 79	+ 49	+ 60	+ 29	+ 40	+ 19	+ 30	+ 46	+ 74	+120	± 6.5	± 9.5	±15	+13	+18	+ 3	+ 4	+ 9	- 6	- 5	0	- 15	- 14	- 9	- 26	- 21	- 30	50	65	0		
		+ 60	+ 30	+ 30	+ 10	+ 10	0	0	0	0	0	0				- 6	- 12	-10	- 15	- 21	- 19	- 24	- 30	- 28	- 33	- 39	- 45	- 51	- 32	- 62	65	80	- 13
80	120	+ 94	+ 58	+ 71	+ 34	+ 47	+ 22	+ 35	+ 54	+ 87	+140	± 7.5	±11	±17.5	+16	+22	+ 2	+ 4	+ 10	- 8	- 6	0	- 18	- 16	- 10	- 30	- 24	- 38	80	100	0		
		+ 72	+ 36	+ 36	+ 12	+ 12	0	0	0	0	0	0				- 6	- 13	-13	- 18	- 25	- 23	- 28	- 35	- 33	- 38	- 45	- 52	- 59	- 38	- 73	100	120	- 15
120	180	+110	+ 68	+ 83	+ 39	+ 54	+ 25	+ 40	+ 63	+100	+160	± 9	±12.5	±20	+18	+26	+ 3	+ 4	+ 12	- 9	- 8	0	- 21	- 20	- 12	- 36	- 28	- 48	120	140	(up to 150)		
		+ 85	+ 43	+ 43	+ 14	+ 14	0	0	0	0	0	0				- 7	- 14	-15	- 21	- 28	- 27	- 33	- 40	- 39	- 45	- 52	- 61	- 68	- 50	- 90	140	160	0
																													- 53	- 93	160	180	(over to 150)
																														- 60	- 106	180	200
180	250	+129	+ 79	+ 96	+ 44	+ 61	+ 29	+ 46	+ 72	+115	+185	±10	±14.5	±23	+22	+30	+ 2	+ 5	+ 13	- 11	- 8	0	- 25	- 22	- 14	- 41	- 33	- 63	200	225	0		
		+100	+ 50	+ 50	+ 15	+ 15	0	0	0	0	0	0				- 7	- 16	-18	- 24	- 33	- 31	- 37	- 46	- 45	- 51	- 60	- 70	- 79	- 63	- 109	225	250	- 30
																													- 67	- 113	225	250	
																													- 74	- 126	250	280	0
250	315	+142	+ 88	+108	+ 49	+ 69	+ 32	+ 52	+ 81	+130	+210	±11.5	±16	±26	+25	+36	+ 3	+ 5	+ 16	- 13	- 9	0	- 27	- 25	- 14	- 47	- 36	- 78	280	315	0		
		+110	+ 56	+ 56	+ 17	+ 17	0	0	0	0	0	0				- 7	- 16	-20	- 27	- 36	- 36	- 41	- 52	- 50	- 57	- 66	- 79	- 88	- 78	- 130	280	315	- 35
																													- 87	- 144	315	355	0
315	400	+161	+ 98	+119	+ 54	+ 75	+ 36	+ 57	+ 89	+140	+230	±12.5	±18	±28.5	+29	+39	+ 3	+ 7	+ 17	- 14	- 10	0	- 30	- 26	- 16	- 51	- 41	- 93	355	400	0		
		+125	+ 62	+ 62	+ 18	+ 18	0	0	0	0	0	0				- 7	- 18	-22	- 29	- 40	- 39	- 46	- 57	- 55	- 62	- 73	- 87	- 98	- 103	- 150	355	400	- 40
																													- 93	- 150	355	400	
400	500	+175	+108	+131	+ 60	+ 83	+ 40	+ 63	+ 97	+155	+250	±13.5	±20	±31.5	+33	+43	+ 2	+ 8	+ 18	- 16	- 10	0	- 33	- 27	- 17	- 55	- 45	- 103	400	450	0		
		+135	+ 68	+ 68	+ 20	+ 20	0	0	0	0	0	0				- 7	- 20	-25	- 32	- 45	- 43	- 50	- 63	- 60	- 67	- 80	- 95	- 108	- 109	- 172	450	500	- 45
																													- 150	- 220	500	560	0
500	630	+189	+120	+146	+ 66	+ 92	+ 44	+ 70	+110	+175	+280	±16	±22	±35	-	-	0	0	0	- 26	- 26	- 26	- 44	- 44	- 44	- 78	- 78	- 155	560	630	0		
		+145	+ 76	+ 76	+ 22	+ 22	0	0	0	0	0	0				-	-	-32	- 44	- 70	- 58	- 70	- 96	- 76	- 88	- 114	- 122	- 148	- 122	- 148	560	630	- 50
																														- 175	- 255	630	710
630	800	+210	+130	+160	+ 74	+104	+ 50	+ 80	+125	+200	+320	±18	±25	±40	-	-	0	0	0	- 30	- 30	- 30	- 50	- 50	- 50	- 88	- 88	- 185	710	800	0		
		+160	+ 80	+ 80	+ 24	+ 24	0	0	0	0	0	0				-	-	-36	- 50	- 80	- 66	- 80	- 110	- 86	- 100	- 130	- 138	- 168	- 103	- 166	800	900	- 75
																													- 175	- 255	630	710	
800	1000	+226	+142	+176	+ 82	+116	+ 56	+ 90	+140	+230	+360	±20	±28	±45	-	-	0	0	0	- 34	- 34	- 34	- 56	- 56	- 56	- 100	- 100	- 210	800	900	0		
		+170	+ 86	+ 86	+ 26	+ 26	0	0	0	0	0	0				-	-	-40	- 56	- 90	- 74	- 90	- 124	- 96	- 112	- 146	- 156	- 190	- 220	- 310	900	1000	- 100
																													- 260	- 365	800	900	
1000	1250	+261	+164	+203	+ 94	+133	+ 66	+105	+165	+260	+420	±23.5	±33	±52.5	-	-	0	0	0	- 40	- 40	- 40	- 66	- 66	- 66	- 120	- 120	- 250	1000	1120	0		
		+195	+ 98	+ 98	+ 28	+ 28	0	0	0	0	0	0				-	-	-47	- 66	- 105	- 87	- 106	- 145	- 113	- 132	- 171	- 186	- 225	- 260	- 365	1120	1250	- 125
																													- 300	- 425	1000	1120	
1250	1600	+298	+188	+235	+108	+155	+ 78	+125	+195	+310	+500	±27.5	±39	±62.5	-	-	0	0	0	- 48	- 48	- 48	- 78	- 78	- 78	- 140	- 140	- 330	1250	1400	0		
		+220	+110	+110	+ 30	+ 30	0	0	0	0	0	0				-	-	-55	- 78	- 125	- 103	- 126	- 173	- 133	- 156	- 203	- 218	- 265	- 330	- 455	1400	1600	- 160
																													- 370	- 520	1250	1400	
1600	2000	+332	+212	+270	+124	+182	+ 92	+150	+230	+370	+600	±32.5	±46	±75	-	-	0	0	0	- 58	- 58	- 58	- 92	- 92	- 92	- 170	- 170	- 400	1600	1800	0		
		+240	+120	+120	+ 32	+ 32	0	0	0	0	0	0				-	-	-65	- 92	- 150	- 123	- 150	- 208	- 157	- 184	- 242	- 262	- 320	- 400	- 550	1800	2000	- 200
																													- 440	- 615	1600	1800	
2000	2500	+370	+240	+305	+144	+209	+110	+175	+280	+440	+700	±39	±55	±87.5	-	-	0	0	0	- 68	- 68	- 68	- 110	- 110	- 110	- 195	- 195	- 460	2000	2240	0		
		+260	+130	+130	+ 34	+ 34	0	0	0	0	0	0				-	-	-78	- 110	- 175	- 146	- 178	- 243	- 188	- 220	- 285	- 305	- 370	- 460	- 635	2240	2500	- 250

[Note] 1)  $\Delta D_{mp}$  : single plane mean outside diameter deviation



# GLOBAL NETWORK

## BEARING BUSINESS OPERATIONS

### JTEKT CORPORATION NAGOYA HEAD OFFICE

No.7-1, Meieki 4-chome, Nakamura-ku, Nagoya, Aichi 450-8515,  
JAPAN  
TEL : 81-52-527-1900  
FAX : 81-52-527-1911

### JTEKT CORPORATION OSAKA HEAD OFFICE

No.5-8, Minamisemba 3-chome, Chuo-ku, Osaka 542-8502,  
JAPAN  
TEL : 81-6-6271-8451  
FAX : 81-6-6245-3712

### Sales & Marketing Headquarters

No.5-8, Minamisemba 3-chome, Chuo-ku, Osaka 542-8502,  
JAPAN  
TEL : 81-6-6245-6087  
FAX : 81-6-6244-9007

## OFFICES

### KOYO CANADA INC.

5324 South Service Road, Burlington, Ontario L7L 5H5, CANADA  
TEL : 1-905-681-1121  
FAX : 1-905-681-1392

### KOYO CORPORATION OF U.S.A.

#### -Cleveland Office-

29570 Clemens Road, P.O.Box 45028 Westlake,  
OH 44145, U.S.A.  
TEL : 1-440-835-1000  
FAX : 1-440-835-9347

#### -Detroit Office-

47771 Halyard Drive, Plymouth, MI 48170, U.S.A.  
TEL : 1-734-454-1500  
FAX : 1-734-454-4076

### KOYO MEXICANA, S.A. DE C.V.

Rio Nazas No.171, 3er piso, Col. Cuauhtemoc, México, D.F. C.P.  
06500, MÉXICO  
TEL : 52-55-5207-3860  
FAX : 52-55-5207-3873

### KOYO LATIN AMERICA, S.A.

Edificio Banco del Pacifico Planta Baja, Calle Aquilino de la  
Guardia y Calle 52, Panama, REPUBLICA DE PANAMA  
TEL : 507-208-5900  
FAX : 507-264-2782/507-269-7578

### KOYO ROLAMENTOS DO BRASIL LTDA.

Rua Desembargador Eliseu Gzilherme 304, 7-Andar, Paraiso,  
CEP 04004-30, BRASIL  
TEL : 55-11-3887-9173  
FAX : 55-11-3887-3039

### JTEKT (THAILAND) Co., LTD.

172/1 Moo 12 Tambol Bangwua, Amphur Bangpakong,  
Chachoengsao 24180, THAILAND  
TEL : 66-38-533-310-7  
FAX : 66-38-532-776

### PT. JTEKT INDONESIA

MM2100 Industrial Town Block DD-3, Cikarang Barat, Bekasi  
17520, INDONESIA  
TEL : 62-21-8998-3273  
FAX : 62-21-8998-3274

### KOYO SINGAPORE BEARING (PTE.) LTD.

27, Penjuru Lane, #09-01 C&P Logistics Hub 2, SINGAPORE  
609195  
TEL : 65-6274-2200  
FAX : 65-6862-1623

### -MIDDLE EAST (BRANCH)-

6EA312, Dubai Airport Free Zone, P.O. Box 54816, Dubai, U.A.E.  
TEL : 971-4-2993600  
FAX : 971-4-2993700

### PHILIPPINE KOYO BEARING CORPORATION

6th Floor One World Square Building, #10 Upper McKinley Road,  
McKinley Town Center, Fort Bonifacio, 1634 Taguig City,  
PHILIPPINES  
TEL : 63-2-856-5046/5047  
FAX : 63-2-856-5045

### JTEKT KOREA CO., LTD.

Inwoo Building 6F, 539-11, Shinsa-Dong,  
Kangnam-Ku, Seoul, KOREA  
TEL : 82-2-549-7922  
FAX : 82-2-549-7923

### JTEKT (CHINA) CO., LTD.

Rm.1906, Aetna Tower, 107 Zunyi Road, Shanghai, 200051,  
CHINA  
TEL : 86-21-6237-5280  
FAX : 86-21-6237-5277

### KOYO (SHANGHAI) CO., LTD.

Rm.1905, Aetna Tower, 107 Zunyi Road, Shanghai, 200051,  
CHINA  
TEL : 86-21-6237-5280  
FAX : 86-21-6237-5277

### KOYO AUSTRALIA PTY. LTD.

Unit 2, 8 Hill Road, Homebush Bay, NSW 2127, AUSTRALIA  
TEL : 61-2-8719-5300  
FAX : 61-2-8719-5333

### JTEKT EUROPE BEARINGS B.V.

Markerkant 13-01, 1314 AN Almere, THE NETHERLANDS  
TEL : 31-36-5383333  
FAX : 31-36-5347212

### KOYO KULLAGER SCANDINAVIA A.B.

Johanneslundsvägen 4, 194 61 Uppiands Väsby, SWEDEN  
TEL : 46-8-594-212-10  
FAX : 46-8-594-212-29

### KOYO (U.K.) LTD.

Whitehall Avenue, Kingston, Milton Keynes MK10 OAX,  
UNITED KINGDOM  
TEL : 44-1908-289300  
FAX : 44-1908-289333

### KOYO ROMANIA REPRESENTATIVE OFFICE

Str. Frederic Jolliot-Curie, Nr.3, Etaj 1, Ap.2, Sector 5  
Bucharest, ROMANIA  
TEL : 40-21-410-4170/4182/0984  
FAX : 40-21-410-1178

### KOYO DEUTSCHLAND GMBH.

Bargkoppelweg 4, D-22145 Hamburg, GERMANY  
TEL : 49-40-67-9090-0  
FAX : 49-40-67-9203-0

### KOYO FRANCE S.A.

8 Rue Guy Moquet, B.P. 189 Z.I., 95105 Argenteuil Cedex, FRANCE  
TEL : 33-1-3998-4202  
FAX : 33-1-3998-4244/4249

### KOYO IBERICA, S.L.

Avda.da la Industria, 52-2 izda 28820  
Coslada Madrid, SPAIN  
TEL : 34-91-329-0818  
FAX : 34-91-747-1194

### KOYO ITALIA S.R.L.

Via Bronzino 9, 20133 Milano, ITALY  
TEL : 39-02-2951-0844  
FAX : 39-02-2951-0954

## BEARING PLANTS

### KOYO CORPORATION OF U.S.A. (MANUFACTURING DIVISION)

#### -Orangeburg Plant-

2850 Magnolia Street, Orangeburg, SC 29115, U.S.A.  
TEL : 1-803-536-6200  
FAX : 1-803-534-0599

#### -Richland Plant-

1006 Northpoint Blvd., Blythewood, SC 29016, U.S.A.  
TEL : 1-803-691-4624/4633  
FAX : 1-803-691-4655

### JTEKT (THAILAND) Co., LTD.

172/1 Moo 12 Tambol Bangwua, Amphur Bangpakong,  
Chachoengsao 24180, THAILAND  
TEL : 66-38-531-988/993  
FAX : 66-38-531-996

### KOYO MANUFACTURING (PHILIPPINES) CORP.

Lima Technology Center, Municipality of Malvar, Batangas  
Province, 4233 PHILIPPINES  
TEL : 63-43-981-0088  
FAX : 63-43-981-0001

### KOYO JICO KOREA CO., LTD

28-12, Yulpo-Ri, Koduc-Myun, Pyung Teak-City, Kyungki-Do, KOREA  
TEL : 82-31-668-6381  
FAX : 82-31-668-6384

### KOYO BEARING DALIAN CO., LTD.

No.II A-2 Dalian Export Processing Zone, 116600, CHINA  
TEL : 86-411-8731-0972/0974  
FAX : 86-411-8731-0973

### WUXI KOYO BEARING CO., LTD.

Wuxi Li Yuan Economic Development Zone, Wuxi, 214072,  
CHINA  
TEL : 86-510-85161901  
FAX : 86-510-85161143

### DALIAN KOYO WAZHOU AUTOMOBILE BEARING CO., LTD.

No.96, Liaohe East Road, D.D Port, Dalian, 116620, CHINA  
TEL : 86-411-8740-7272  
FAX : 86-411-8740-7373

### KOYO LIOHO (FOSHAN) AUTOMOTIVE PARTS CO., LTD.

No.12, Wusha Section Of Shunpan Road, Daliang Town, Shunde  
Of Foshan, Guangdong, Province, CHINA  
(SHUNDE INDUSTRIAL PARK)  
TEL : 86-757-22829589  
FAX : 86-757-22829586

### KOYO AUTOMOTIVE PARTS (WUXI) CO.,LTD.

B6-A New District, Wuxi, 214028, CHINA  
TEL : 86-510-8533-0909  
FAX : 86-510-8533-0155

### KOYO BEARINGS (EUROPE) LTD.

P.O.Box 101, Elmhirst Lane, Dodworth, Barnsley,  
South Yorkshire, S75 3TA, UNITED KINGDOM  
TEL : 44-1226-733200  
FAX : 44-1226-204029

### KOYO ROMANIA S.A.

Turnu Magurele Street No.1, 140003, ALEXANDRIA Teleorman  
County, ROMANIA  
TEL : 40-247-306-400  
FAX : 40-247-306-421

## TECHNICAL CENTERS

### JTEKT CORPORATION NORTH AMERICAN TECHNICAL CENTER

47771 Halyard Drive, Plymouth, MI 48170, U.S.A.  
TEL : 1-734-454-1500  
FAX : 1-734-454-4076

### JTEKT (CHINA) CO., LTD. TECHNICAL CENTER

Rm.1905, Aetna Tower, 107 Zunyi Road, Shanghai, 200051,  
CHINA  
TEL : 86-21-6237-5280  
FAX : 86-21-6237-5277

### JTEKT CORPORATION EUROPEAN TECHNICAL CENTER

Markerkant 13-02, 1314 AN Almere, THE NETHERLANDS  
TEL : 31-36-5383350  
FAX : 31-36-5302656

# **Koyo**® **LARGE SIZE** **BALL & ROLLER BEARINGS**

**Value & Technology**



This catalog has been printed on paper of recycled paper pulp using environmentally friendly soy ink.



**CAT. NO. B2002E**  
Printed in Japan '09.9-1CDS ('08.7)